

ABB solar inverters

Product manual

PVI-10.0/12.5-TL-OUTD (10.0 to 12.5 kW)





IMPORTANT SAFETY INSTRUCTIONS

This manual contains important safety instructions that must be followed during installation and maintenance of the equipment.



Operators are required to read this manual and scrupulously follow the indications reported in it, since ABB cannot be held responsible for damages caused to people and/or things, or the equipment, if the warranty conditions are not observed.

Product Manual

PVI-10.0/12.5-TL-OUTD string inverters

1 - Introduction and general information



2 - Characteristics



3 - Safety and accident prevention



4 - Lifting and transport



5 - Installation



6 - Instruments



7 - Operation



8 - Maintenance



Warranty and Supply Conditions

The warranty conditions are considered to be valid if the customer adheres to the indications in this manual; any conditions deviating from those described herein must be expressly agreed in the purchase order.

The equipment complies with the pertinent legislation currently in force in the country of installation and it has issued the corresponding declaration of conformity.

Not included in the supply



ABB accepts no liability for failure to comply with the instructions for correct installation and will not be held responsible for systems upstream or downstream the equipment it has supplied. It is absolutely forbidden to modify the equipment. Any modification, manipulation, or alteration not expressly agreed with the manufacturer, concerning either hardware or software, shall result in the immediate cancellation of the warranty.

The Customer is fully liable for any modifications made to the system.

Given the countless array of system configurations and installation environments possible, it is essential to check the following: sufficient space suitable for housing the equipment; airborne noise produced depending on the environment; potential flammability hazards.

ABB will NOT be held liable for defects or malfunctions arising from: improper use of the equipment; deterioration resulting from transportation or particular environmental conditions; performing maintenance incorrectly or not at all; tampering or unsafe repairs; use or installation by unqualified persons.

ABB will NOT be held responsible for the disposal of: displays, cables, batteries, accumulators etc. The Customer shall therefore arrange for the disposal of substances potentially harmful to the environment in accordance with the legislation in force in the country of installation.

Contents

| | |
|---|-----------|
| Introduction and general information | 4 |
| Warranty and Supply Conditions | 4 |
| Not included in the supply..... | 4 |
| Contents | 5 |
| Reference number index | 8 |
| Graphical representation of references | 8 |
| Scope and target audience | 9 |
| Purpose and document structure | 9 |
| List of appendix documents..... | 9 |
| Operator and maintenance personnel skills/prerequisites | 9 |
| Symbols and signs | 10 |
| Field of use, general conditions | 11 |
| Intended or allowed use..... | 11 |
| Limits in field of use..... | 11 |
| Improper or prohibited use | 11 |
| Characteristics | 12 |
| General conditions | 12 |
| Models and range of equipment | 13 |
| Identification of the equipment and the manufacturer | 14 |
| Characteristics and technical data | 16 |
| Tightening torques | 19 |
| Overall dimensions | 19 |
| Bracket dimensions..... | 20 |
| Efficiency curves | 21 |
| Power derating | 22 |
| Power derating due to environmental conditions | 22 |
| Power reduction due to the input voltage | 23 |
| Characteristics of a photovoltaic generator | 24 |
| Strings and Arrays..... | 24 |
| Description of the equipment | 25 |
| Operating diagram | 25 |
| Connection of several inverters together..... | 26 |
| Notes on the sizing of the system..... | 26 |
| Functionality and components of the equipment | 27 |
| Topographic diagram of the equipment | 28 |
| Safety devices | 30 |
| Anti-Islanding | 30 |
| Input Fuses | 30 |
| Ground fault of the photovoltaic panels | 30 |
| Other safety devices | 30 |
| Safety and accident prevention | 31 |
| Safety information and instructions | 31 |
| Hazardous areas and operations | 32 |
| Environmental conditions and risks | 32 |
| Signs and Labels | 32 |
| Thermal hazard | 33 |
| Clothing and protective devices for staff..... | 33 |



Residual risks34
 Table of residual risks 34

Lifting and transport 35

General conditions35
 Transport and handling 35
 Lifting 35
 Unpacking and checking 35
 List of components supplied 36
 Weight of the groups of device 37

Installation 38

General conditions38
 Environmental checks 39
 Installations above 2000 metres 39
 Installation position 40
Wall mounting41
Operations preparatory to PV generator connection.....42
 Checking the correct polarity of the strings 42
 Checking of leakage to ground of the photovoltaic generator 42
 Choice of differential protection downstream of the inverter 42
Independent or parallel input channels configuration.....44
 Channel configuration examples 45
 Independent channel configuration (default configuration) 46
 Parallel channel configuration 46
Input connection to PV generator (DC side)47
String protection fuses (-FS model only).....49
 Sizing of fuses 49
 Installation procedure for quick fit connectors 51
Grid output connection (AC side).....55
 Characteristics and sizing of the line cable 55
 Load protection switch (AC disconnect switch) 56
 Connection to the AC side terminal board 56
Communication and control board57
Connections to the communication and control board.....58
 Serial Connection Communication (RS485)..... 59
 Procedure for connection to a monitoring system 60
 Remote control connection 61
 Configurable Relay connection (ALARM)..... 61

Instruments 62

General conditions62
 Description of keyboard and LED Panel 63

Operation 64

General conditions64
Monitoring and data transmission65
 User interface mode 65
 Types of data available 65
 Measurement tolerance 65
Commissioning.....66
 Display access and settings 68



| | |
|---|------------|
| LED behaviour | 69 |
| Specifications on the operation of the LEDs..... | 70 |
| LED insulation fault | 70 |
| Description of the menus | 71 |
| General information | 71 |
| Statistics Menu..... | 73 |
| Settings Menu | 75 |
| Info Menu | 83 |
| AUTOTEST procedure in accordance with standard CEI 0-21 | 84 |
| Running the tests from the display menu | 84 |
| Maintenance | 86 |
| General conditions | 86 |
| Routine maintenance | 87 |
| Troubleshooting | 87 |
| Alarm Messages | 87 |
| Power limitation messages..... | 94 |
| Registration on “Registration” website and calculation of second-level password (Service Menu) | 96 |
| Resetting the time remaining to change the grid standard | 99 |
| Replacing the input fuses (version -FS) | 100 |
| Replacement of the buffer battery | 102 |
| Verification of ground leakage | 103 |
| Behaviour of a system without leakage | 103 |
| Behaviour of a system with leakage | 104 |
| Measuring the insulation resistance of photovoltaic generator | 105 |
| Storage and dismantling | 106 |
| Storage of the equipment or long period of non-use..... | 106 |
| Dismantling, decommissioning and disposal..... | 106 |
| Further information | 107 |
| Contact us | 108 |



Reference number index

- 01, Bracket
- 02, Heat sink
- 03, Front cover
- 04, LED Panel
- 05, Display
- 06, Keyboard
- 07, Handles
- 08, DC Disconnect switch
- 09, Input connectors (MPPT1)
- 10, Input connectors (MPPT2)
- 11, AC cable gland
- 12, Service cable glands
- 13, Fuse board (*only version -FS)
- 14, DC Input terminal block
- 15, AC Output terminal block
- 16, AC Grid configuration switch
- 17, Channel configuration switch
- 18, Internal battery
- 19, Alarm terminal block
- 20, Signal terminal block
- 21, RJ45 Connectors
- 22, RS485 line termination switch

Graphical representation of references

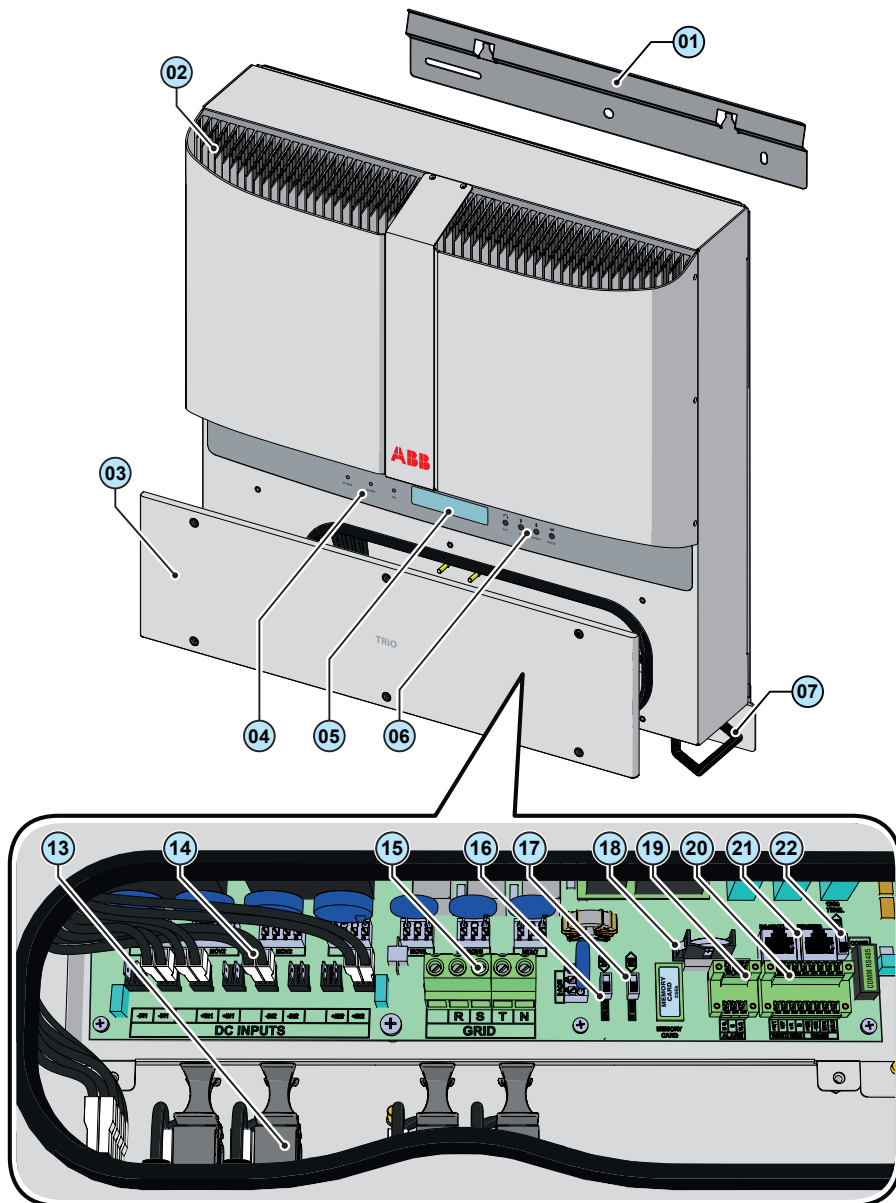

STANDARD VERSION

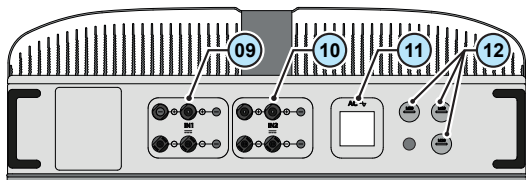

-S / -FS VERSION

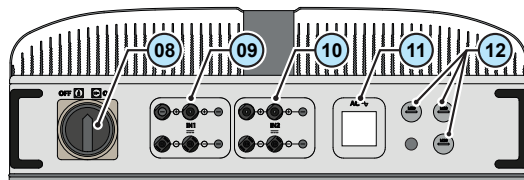

Scope and target audience

Purpose and document structure

This operating and maintenance manual is a useful guide that will enable you to work safely and carry out the operations necessary for keeping the equipment in good working order.



If the equipment is used in a manner not specified in this manual, the protection provided by the equipment may be impaired.



The language in which the document was originally written is ITALIAN; therefore, in the event of inconsistencies or doubts please ask the manufacturer for the original document.

List of appendix documents

In addition to this operating and maintenance manual (if applicable or on request), the following documentation is supplied:

- EC declaration of conformity
- Quick installation guide (QIG)



Part of the information given in this document is taken from the original supplier documents. This document contains only the information considered necessary for the use and routine maintenance of the equipment.

Operator and maintenance personnel skills/prerequisites



Personnel in charge of using and maintaining the equipment must be skilled for the described tasks and must reliably demonstrate their capacity to correctly interpret what is described in the manual.



For safety reasons, only a qualified electrician who has received training and/or demonstrated skills and knowledge of the inverter's structure and operation may install the inverter.



The installation must be performed by qualified installers and/or licensed electricians in accordance with the existing regulations in the country of installation.



Inverter operation and maintenance by a person who is NOT qualified, is intoxicated, or on narcotics, is strictly forbidden.

















The customer has civil liability for the qualification and mental or physical state of the personnel who interact with the equipment. They must always use the personal protective equipment (PPE) required by the laws of the country of destination and whatever is provided by their employer.

Symbols ad signs

In the manual and/or in some cases on the equipment, the danger or hazard zones are indicated with signs, labels, symbols or icons.

Table: Symbols

| | | |
|----------|---|---|
| i |  | <p>This points out that it is mandatory to consult the manual or original document, which must be available for future use and must not be damaged in any way.</p> |
| |  | <p>Generic hazard - Important safety information. This points out operations or situations in which staff must be very careful.</p> |
| |  | <p>Hazardous voltage - This points out operations or situations in which staff must be very careful due to hazardous voltage.</p> |
| |  | <p>Hot parts - This points out a hazard due to the presence of heated areas or in any case areas that have hot parts (danger of burns).</p> |
| |  | <p>This points out that the examined area must not be entered or that the described operation must not be carried out.</p> |
| |  | <p>This points out that it is mandatory to carry out the described operations using the clothing and/or personal protective equipment provided by the employer.</p> |
| |  | <p>This indicates the degree of protection of the equipment according to IEC standard 70-1 (EN 60529 June 1997).</p> |
| |  | <p>Point of connection for grounding protection.</p> |
| |  | <p>This indicates the allowed temperature range</p> |
| |  | <p>This indicates the risk of electric shock. Time need to discharge stored energy: 5/10 minutes</p> |
| |  | <p>Respectively direct current and alternating current</p> |
| |  | <p>Isolating transformer present or not present</p> |
| |  | <p>Positive pole and negative pole of the input voltage (DC)</p> |
| |  | <p>This indicates the centre of gravity of the equipment.</p> |

Field of use, general conditions

ABB shall not be liable for any damages whatsoever that may result from incorrect or careless operations.



*You may not use the equipment for a use that does not conform to that provided for in the field of use. The equipment **MUST NOT** be used by inexperienced staff, or even experienced staff if carrying out operations on the equipment that fail to comply with the indications in this manual and enclosed documentation.*



Intended or allowed use

This equipment is a inverter designed for:
transforming a continuous electrical current (DC)
supplied by a photovoltaic generator (FV)
in an alternating electrical current (AC)
suitable for feeding into the public distribution grid.

Limits in field of use

The inverter can be used only with photovoltaic modules which have ground isolated input poles, unless they are accessories installed that enable earthing of the inputs. In this case you must install an insulating transformer on the AC side of the system.

Only a photovoltaic generator can be connected in the input of the inverter (do not connect batteries or other sources of power supply).

The inverter can be connected to the electricity grid only in countries for which it has been certified/approved.

The inverter cannot be connected to the DC side in parallel to other inverters to convert energy from a photovoltaic generator with a power greater than the nominal power of the single inverter.

The inverter may only be used in compliance with all its technical characteristics.

Improper or prohibited use



IT IS STRICTLY FORBIDDEN TO:

- *Install the equipment in environments subject to particular conditions of flammability or in adverse or disallowed environmental conditions, (temperature and humidity).*
- *Use the equipment with safety devices which are faulty or disabled.*
- *Use the equipment or parts of the equipment by linking it to other machines or equipment, unless expressly provided for.*
- *Modify operating parameters that are not accessible to the operator and/or parts of the equipment to vary its performance or change its isolation.*
- *Clean with corrosive products that could eat into parts of the equipment or generate electrostatic charges.*
- *Use or install the appliance or parts of it without having read and understood the contents of the user and maintenance manual.*
- *Heat or dry rags and clothing on the parts in temperature. In addition to being hazardous, doing so would compromise component ventilation and cooling.*



General conditions

A description of the equipment characteristics is provided to identify its main components and specify the technical terminology used in the manual.

This chapter contains information about the models, details of the equipment, characteristics and technical data, overall dimensions and equipment identification.



The customer/Installer takes full responsibility if, when reading this manual, the chronological order of its presentation provided is not observed. All information is provided considering occasional inclusion of information in previous chapters.



In certain cases, there may be a need to separately document software functionality or attach supplementary documentation to this manual which is intended for more qualified professionals.

Models and range of equipment

The specific models of three-phase inverters covered by this manual are divided into two groups according to their maximum output power: 10.0 kW or 12.5 kW.

For inverters of equal output power the variant between the various models is the presence or lack thereof of the DC disconnect switch ⑧, or the input fuses board ⑬.



The choice of the inverter model must be made by a qualified technician who knows about the installation conditions, the devices that will be installed outside the inverter and possible integration with an existing system.



• PVI-10.0/12.5-TL-OUTD MODELS

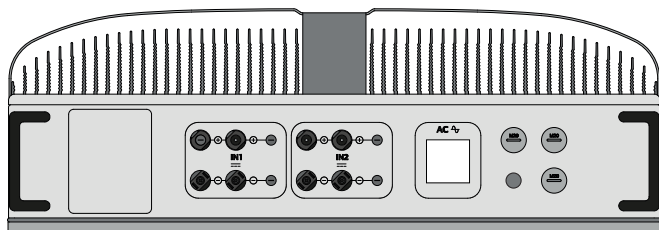

PVI-10.0/12.5-TL-OUTD:

- Number of input channels: 2
- DC disconnect switch ⑧: No
- Input fuses board ⑬: No
- Input connectors: quick fit connectors (2 pair for each channel)

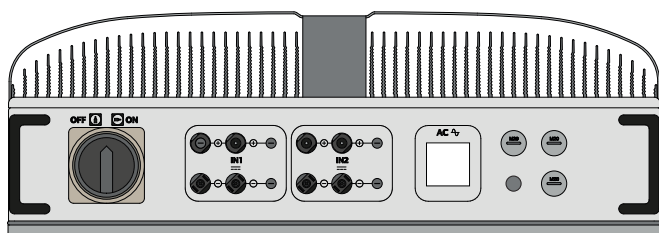

PVI-10.0/12.5-TL-OUTD-S:

- Number of input channels: 2
- DC disconnect switch ⑧: Yes
- Input fuses board ⑬: No
- Input connectors: quick fit connectors (2 pair for each channel)

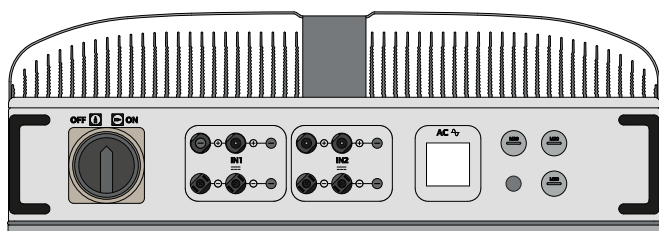

PVI-10.0/12.5-TL-OUTD-FS:

- Number of input channels: 2
- DC disconnect switch ⑧: Yes
- Input fuses board ⑬: Yes
- Input connectors: quick fit connectors (2 pair for each channel)

Identification of the equipment and the manufacturer

The technical data shown in this manual do not in any case replace those shown on the labels attached to the equipment.



The labels attached to the equipment must NOT be removed, damaged, dirtied, hidden, etc.

The approval label contains the following information:

1. Manufacturer
2. Model
3. Rating data
4. Certification marks



N.B. The labels must NOT be hidden with objects and extraneous parts (rags, boxes, equipment, etc.); they must be cleaned regularly and kept visible at all times.

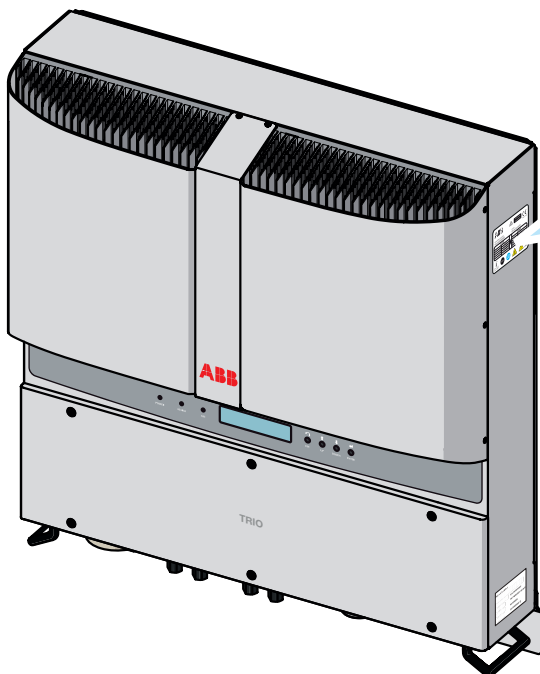

1 **ABB** 4 Made in Italy

www.abb.com/solar SOLAR INVERTER 2 MODEL: PVI-10.0-TL-OUTD

| | | | |
|----------------------------|-------------|------------------------------|----------------------|
| V _{dc} max | 900 V | V _{ac} | 400 V 3Ø |
| V _{dc} MPP | 200 - 850 V | f _r | 50 Hz |
| V _{dc} Full Power | 300 - 750 V | P _{ac} (cosφ = 1) | 10000 W @ 55 °C amb. |
| I _{sc} max | 2 x 17 A | P _{ac} (cosφ = 0.9) | 10000 W @ 50 °C amb. |
| I _{cc} max | 2 x 22 A | I _{cc} max | 16.6 A |

-25 to + 60 °C
-13 to +140 °F





1 **ABB** 4 Made in Italy

www.abb.com/solar SOLAR INVERTER 2 MODEL: PVI-12.5-TL-OUTD

| | | | |
|----------------------------|-------------|------------------------------|----------------------|
| V _{dc} max | 900 V | V _{ac} | 400 V 3Ø |
| V _{dc} MPP | 200 - 850 V | f _r | 50 Hz |
| V _{dc} Full Power | 360 - 750 V | P _{ac} (cosφ = 1) | 12500 W @ 50 °C amb. |
| I _{sc} max | 2 x 18 A | P _{ac} (cosφ = 0.9) | 12500 W @ 45 °C amb. |
| I _{cc} max | 2 x 22 A | I _{cc} max | 20 A |

-25 to + 60 °C
-13 to +140 °F

In addition to the label showing the specifications of the inverter, there are two part identification labels for the inverter and wiring box. These labels list the following information:

| | |
|--|---|
| <p>ABB PVI-XX.X-TL-OUTD-Y</p>     <p>P/N: PXXXXXXXXXX</p> <p>SN: YYWWSSSSSS*WK:WYY</p> <p>WO: XXXXXXXX</p> <p>SO: SXXXXXXXXX Q1</p> | <ul style="list-style-type: none"> • Inverter model <ul style="list-style-type: none"> - XX.X = Inverter power rating: - Y = Integrated disconnect switch / Input fuses board with Integrated disconnect switch • Inverter Part Number • Inverter Serial Number composed of: <ul style="list-style-type: none"> - YY = Year of manufacture - WW = Week of manufacture - SSSSSS = sequential number • Week/Year of manufacture |
|--|---|



The officially required information is located on the approval label. The identification label is an accessory label which shows the information necessary for the identification and characterisation of the inverter by ABB.



N.B. The labels must NOT be hidden with objects and extraneous parts (rags, boxes, equipment, etc.); they must be cleaned regularly and kept visible at all times.

Characteristics and technical data

| Table: Technical Data | PVI-10.0-TL-OUTD | PVI-12.5-TL-OUTD |
|--|---|--|
| Input | | |
| Absolute Maximum Input Voltage ($V_{max,abs}$) | 900 V | |
| Rated Input Voltage (V_{dcr}) | 580 V | |
| Input start-up voltage (V_{start}) | 360 V (adj. 250...500 V) | |
| Input operating interval ($V_{dcrmin}...V_{dcrmax}$) | 0.7 x V_{start} ...850 V (min 200 V) | |
| Input Nominal Power (P_{dcr}) | 10300 W | 12800 W |
| Number of Independent MPPT | 2 | |
| Maximum input power for Each MPPT (PMPPTmax) | 6500 W | 8000 W |
| Input voltage interval ($V_{MPPTmin} ... V_{MPPTmax}$) to P_{acr} (parallel MPPT configuration) | 300...750 V | 360...750 V |
| DC Power limiting for each MPPT with Independent MPPT Configuration to P_{acr} , maximum unbalance example | 6500 W [$380V \leq V_{MPPT} \leq 750V$] other channel: P_{dcr} -6500W [$225V \leq V_{MPPT} \leq 750V$] | 8000 W [$445V \leq V_{MPPT} \leq 750V$] other channel: P_{dcr} -8000W [$270V \leq V_{MPPT} \leq 750V$] |
| Maximum DC Input Current (I_{dcrmax}) / for each MPPT ($I_{MPPTmax}$) | 34.0 A / 17.0 A | 36.0 A / 18.0 A |
| Maximum Return current (AC side vs DC side) | Negligible | |
| Number of DC Connection Pairs in Input for each MPPT | 2 | |
| DC Input Connector type (components indicated or equivalents) | Quick Fit PV Connector ⁽⁵⁾ | |
| Type of photovoltaic panels that can be connected at input according to IEC 61730 | Class A | |
| Input protection | | |
| Reverse Polarity Protection | Inverter protection only, from limited current source, for standard and -S versions, and for -FS version when max 2 strings are connected | |
| Input Overvoltage protection for each MPPT - Varistors | Yes | |
| Maximum short-circuit current for each MPPT | 22.0 A | |
| Insulation Check | Complying with the local standard | |
| DC Disconnect Switch rating (-S Version) | Max. 32.0 A / 1000 V | |
| Fuse Rating (-FS Version) | gPV / 1000 V / Max. 20.0 A | |





| Table: Technical Data | PVI-10.0-TL-OUTD | PVI-12.5-TL-OUTD |
|---|--|--|
| Output | | |
| AC Connection to the grid | Three phase 3W or 4W+PE | |
| Nominal AC output voltage (V_{acr}) | 400 V | |
| Output voltage range ($V_{acmin}...V_{acmin}$) | 320...480 V ⁽¹⁾ | |
| Nominal AC Output Power ($P_{acr} @\cos\phi=1$) | 10000 W | 12500 W |
| Maximum AC Output Power ($P_{acmax} @\cos\phi=1$) | 11000 W ⁽³⁾ | 13800 W ⁽⁴⁾ |
| Maximum apparent Output power (S_{max}) | 11500 VA | 13800 VA |
| Maximum output current (I_{acmax}) | 16.6 A | 20.0 A |
| Contribution to short-circuit current | 19.0 A | 22.0 A |
| Inrush current | Negligible | |
| Maximum fault current | <25 A rms (100ms) | |
| Rated Output Frequency (f_r) | 50 Hz / 60 Hz | |
| Output Frequency Range ($f_{min}...f_{max}$) | 47...53 Hz / 57...63 Hz ⁽²⁾ | |
| Nominal Power Factor | > 0.995 (adj. \pm 0.9 with $P_{acr} = 10.0$ kW \pm 0.8 with max 11.5kVA) | > 0.995 (adj. \pm 0.9 with $P_{acr} = 12.5$ kW \pm 0.8 with max 13.8kVA) |
| Total Current Harmonic Distortion | < 2% | |
| AC Connections Type | Screw Terminal block (max cross-section 16 mm ²); cable gland M40 | |
| Output protection | | |
| Anti-islanding Protection | Complying with the local standard | |
| Maximum AC Overcurrent external protection | 25.0 A | |
| Output overvoltage protection - Varistors | 4, plus gas arrester | |
| Operating performance | | |
| Maximum Efficiency (η_{max}) | 97.8% | |
| Weighted Efficiency (EURO/CEC) | 97.1% / - | 97.2% / - |
| Power Supply Threshold | 30.0 W | |
| Night-Time Consumption | < 1.0 W | |
| Communication | | |
| Wired Local Monitoring (opt.) | PVI-USB-RS232_485 (opz.) | |
| Remote Monitoring (opt.) | VSN300 Wifi Logger Card (opz.), PVI-AEC-EVO (opz.), VSN700 Data Logger (opz.) | |
| Wireless Local Monitoring (opt.) | VSN300 Wifi Logger Card (opz.) | |
| User Interface | LCD Display with 16 characters x 2 line | |

| Table: Technical Data | PVI-10.0-TL-OUTD | PVI-12.5-TL-OUTD |
|---|---|--|
| Environmental | | |
| Ambient temperature | -25...+60°C -13...140°F with derating above 55°C / 131°F | -25...+60°C -13...140°F with derating above 50°C / 122°F |
| Storage temperature | -40...80°C (-40...+176°F) | |
| Relative Humidity | 0...100% condensing | |
| Typical noise emission pressure | 50 dbA @ 1 m | |
| Maximum operating altitude | 2000 m / 6560 ft | |
| Environmental pollution classification for external environment | 3 | |
| Environmental Category | External | |
| Physical | | |
| Environmental Protection Rating | IP 65 | |
| Cooling System | Natural | |
| Overvoltage rating as per IEC 62109-1 | II (DC input) III (AC output) | |
| Dimensions (H x W x D) | 716mm x 645mm x 224mm / 28.2" x 25.4" x 8.8" | |
| Weight | < 41 kg / 90.4 lb | |
| Assembly System | Wall bracket | |
| Safety | | |
| Safety class | I | |
| Insulation level | Without transformer (TL) | |
| Marking | CE (only 50Hz), RCM | |
| Safety and EMC Standards | EN 50178, EN 62109-1, EN 62109-2, AS/NZS 3100, AS/NZS 60950.1, EN 61000-6-2, EN 61000-6-3, EN 61000-3-11, EN 61000-3-12 | |
| Grid Standard | CEI 0-21, CEI 0-16, DIN V VDE 0126-1-1, VDE-AR-N 4105, G59/3, C10/11, EN 50438 (not for all national appendices), RD1699, RD413, RD661, P.O.12.3, AS/NZS 4777.2, AS/NZS 4777.3, IEC 61727, IEC 62116 BDEW, MEA, NRS 097-2-1 | |

1. The AC voltage range may vary depending on specific country grid standard
2. The Frequency range may vary depending on specific country grid standard
3. Limited to 10000 W for Belgium and Germany
4. Limited to 12500 W for Germany
5. Refer to the document "String inverter – Product Manual appendix" available at www.abb.com/solarinverters to know the brand and the model of the quick fit connector

Remark. Features not specifically listed in the present data sheet are not included in the product

Tightening torques

To maintain the IP65 protection of the system and for optimal installation, the following tightening torques must be used:

| | |
|---|---------|
| AC cable gland ⑪ M40 (ring nut fixing) | 5.0 Nm |
| AC cable gland ⑪ M40 (locknut fixing) | 8.0 Nm |
| Service cable glands ⑫ M20 (ring nut fixing) | 2.5 Nm |
| Service cable glands ⑫ M20 (locknut fixing) | 7.0 Nm |
| Front cover ⑬ | 1.5 Nm |
| AC output terminal block ⑮ - 16 mm ² Max | 1.5 Nm |
| Alarm terminal block ⑰ - 1.5 mm ² Max | 0.25 Nm |
| Signal terminal block ⑳ - 1.5 mm ² Max | 0.25 Nm |



Overall dimensions

The overall dimensions are expressed in millimetres and inches and include the wall installation bracket.

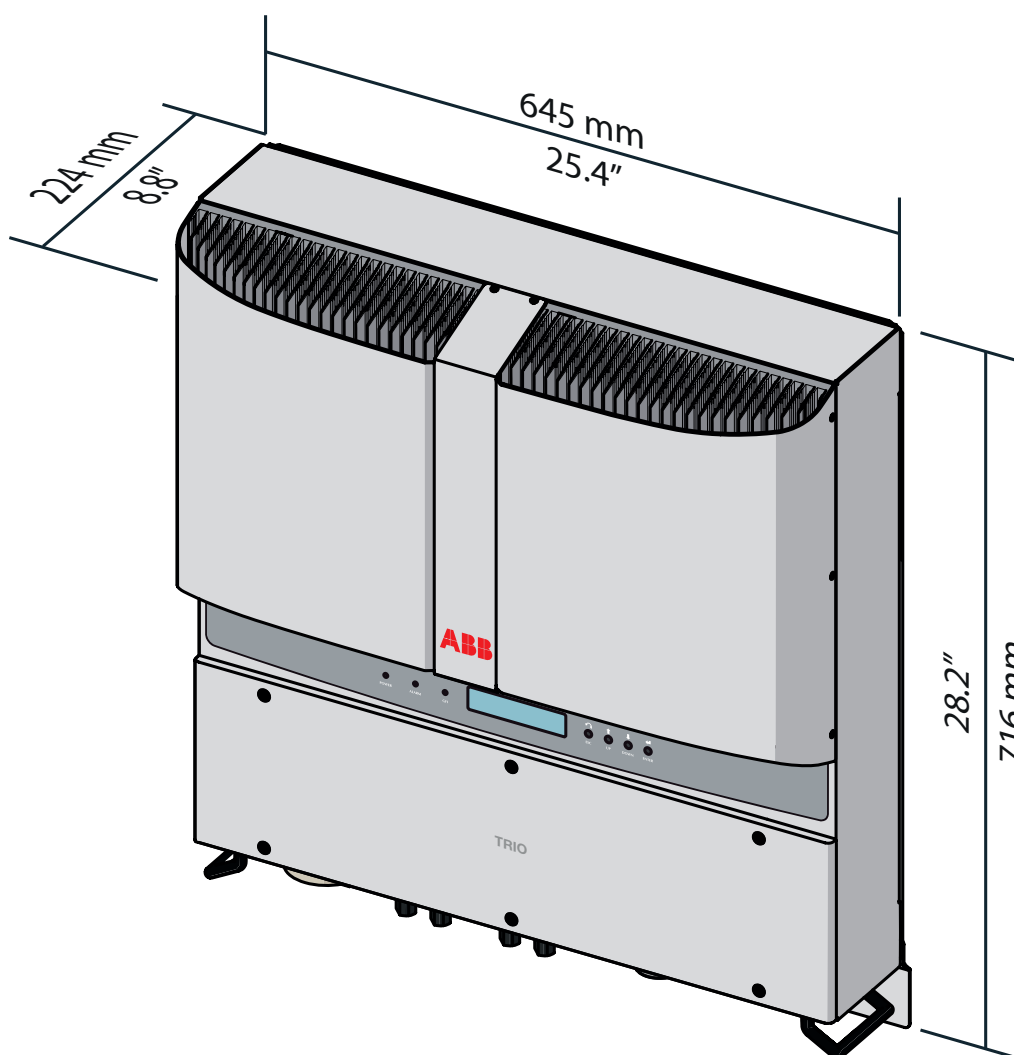

Bracket dimensions

The wall mounting bracket dimensions are expressed in mm and inches

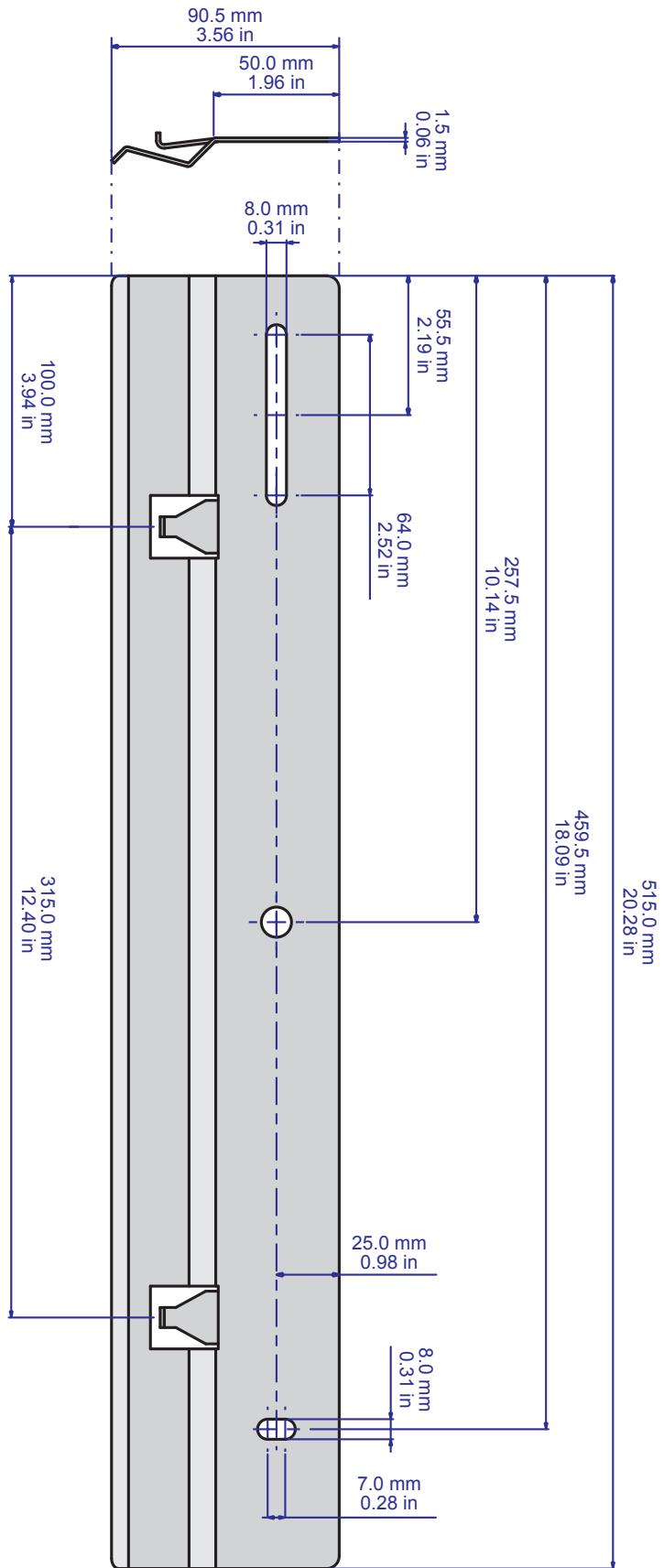

Efficiency curves

The equipment was designed in consideration of current energy conservation standards, to avoid waste and unnecessary leakage.

Graphs of the efficiency curves of all models of inverter described in this manual are shown below.

The efficiency curves are linked to technical parameters that are continually being developed and improved and should therefore be considered approximate.



PVI-10.0-TL-OUTD
 PVI-10.0-TL-OUTD-S
 PVI-10.0-TL-OUTD-FS

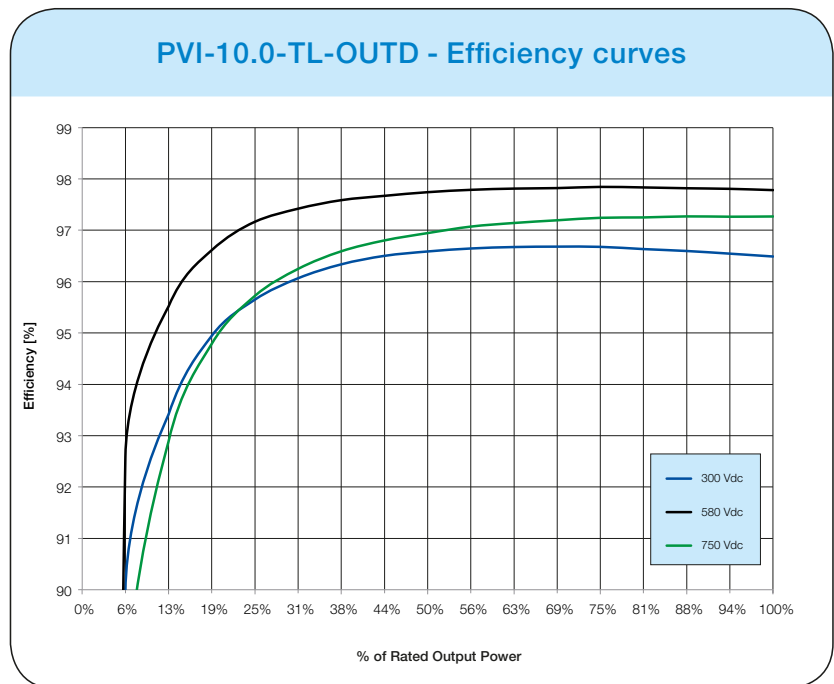

PVI-12.5-TL-OUTD
 PVI-12.5-TL-OUTD-S
 PVI-12.5-TL-OUTD-FS

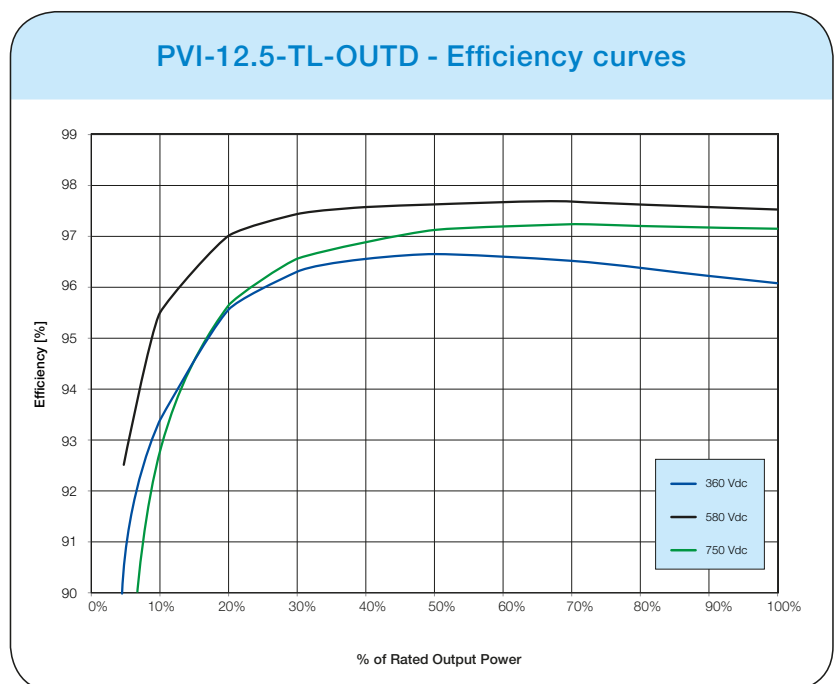

Power derating

In order to allow inverter operation in safe thermal and electrical conditions, the unit automatically reduces the value of the power fed into the grid.

Power limiting may occur due to:

- Adverse environmental conditions (thermal derating)
- Percentage of output power (value set by the user)
- Grid voltage over frequency (mode set by user)
- Grid over voltage $U > 10\text{min Der.}$ (enabling carried out by user)
- Anti-islanding
- Grid under voltage
- Input voltage values too high.
- Input current values too high.



Power derating due to environmental conditions

The power reduction value and the inverter temperature at which it occurs depend on the ambient temperature and on many operating parameters. Example: input voltage, grid voltage and power available from the photovoltaic field.

The inverter can therefore reduce the power during certain periods of the day according to the value of these parameters.

In any case, the inverter guarantees the maximum output power even at high temperatures, provided the sun is not shining directly on it.

Power reduction due to the input voltage

The graphs show the automatic reduction of supplied power when input voltage values are too high or too low.

PVI-10.0-TL-OUTD
 PVI-10.0-TL-OUTD-S
 PVI-10.0-TL-OUTD-FS
 PVI-12.5-TL-OUTD
 PVI-12.5-TL-OUTD-S
 PVI-12.5-TL-OUTD-FS

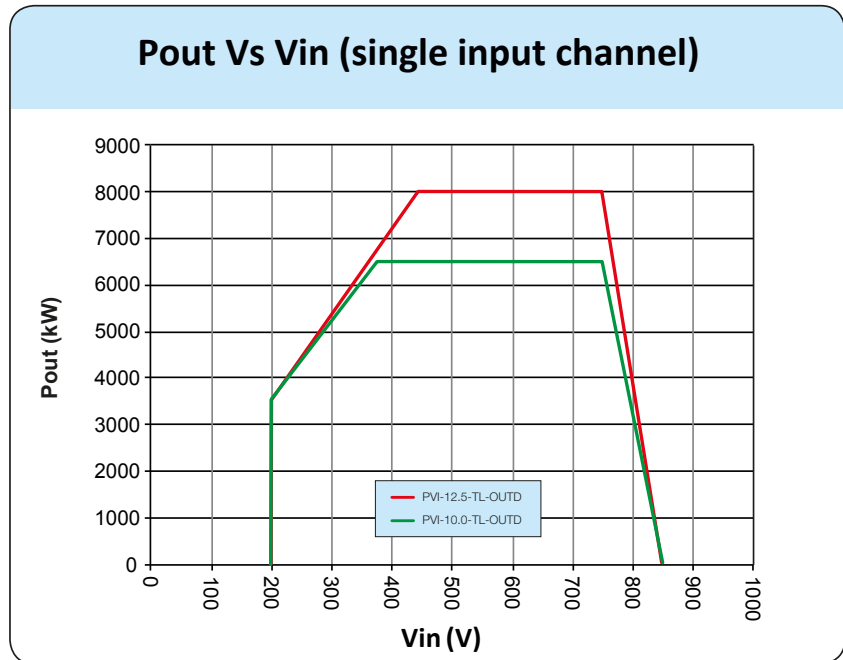

PVI-10.0-TL-OUTD
 PVI-10.0-TL-OUTD-S
 PVI-10.0-TL-OUTD-FS
 PVI-12.5-TL-OUTD
 PVI-12.5-TL-OUTD-S
 PVI-12.5-TL-OUTD-FS

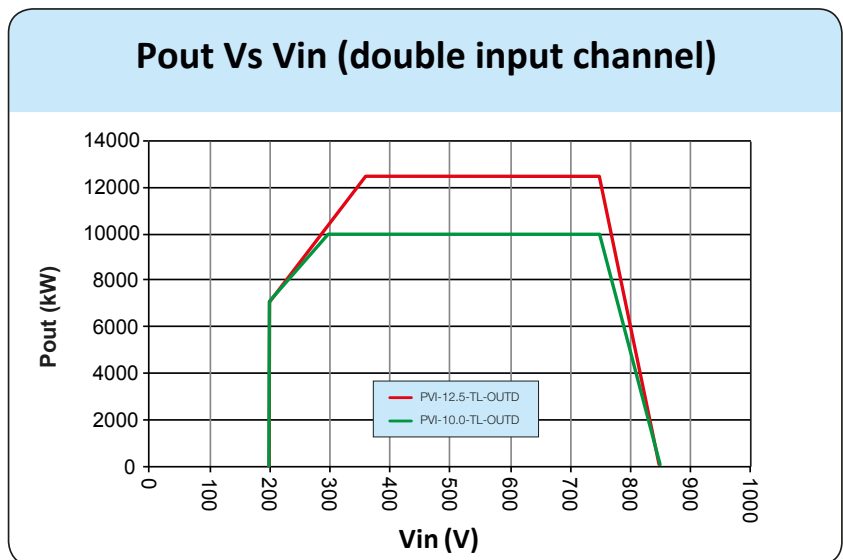

Characteristics of a photovoltaic generator

A PV generator consists of an assembly of photovoltaic panels that transform solar radiation into DC electrical energy and can be made up of:

Strings: X number of PV panels connected in series

Array: group of X strings connected in parallel

Strings and Arrays

In order to considerably reduce the cost of installing a photovoltaic system, mainly associated with the problem of wiring on the DC side of the inverter and subsequent distribution on the AC side, the string technology has been developed. A photovoltaic panel consists of many photovoltaic cells mounted on the same support.

- A string consists of a certain number of panels connected in series.
- An array consists of two or more strings connected in parallel.

Large photovoltaic systems can be made up of several arrays, connected to one or more inverters.

By maximizing the number of panels inserted into each string, it is possible to reduce the cost and complexity of the connection system of the photovoltaic system.

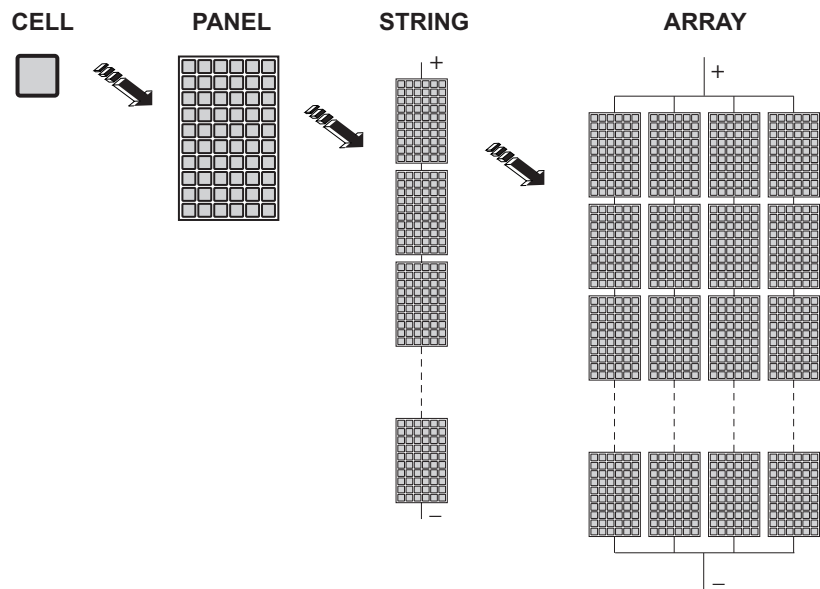

The current of each array must fall within the limits of the inverter.



To work, the inverter must be connected to the national electricity grid since its operation can be equated to a current generator that supplies power in parallel with the grid voltage. That is why inverters cannot support the grid voltage (islanding).

Description of the equipment

This equipment is an inverter that converts direct electric current from a photovoltaic generator into alternating electric current and feeds it into the national grid.

Photovoltaic panels transform energy from the sun into direct current (DC) electrical energy (through a photovoltaic field, also called photovoltaic (PV) generator; in order to use it it is necessary to transform the type of alternating current into "AC". This conversion, known as DC to AC inversion, is made efficiently without using rotating parts and only through static electronic devices.

In order to allow inverter operation in safe thermal and electrical conditions, in the event of adverse environmental conditions or unsuitable input voltage values, the unit automatically reduces the value of the power fed into the grid.

This way the solar energy system compensates for the energy drawn from the utilities connected to the grid to which it is linked.

The solar energy system therefore powers all connected electrical devices, from lighting to household appliances, etc.

When the photovoltaic system is not supplying sufficient power, the power needed to ensure normal operation of the connected electrical devices is drawn from the national grid. If, on the other hand, excess power is produced, this is fed directly into the grid, so becoming available to other consumers.

In accordance with local and national regulations, the power produced can be sold to the grid or credited towards future consumption, so bringing about a saving of money.



Operating diagram

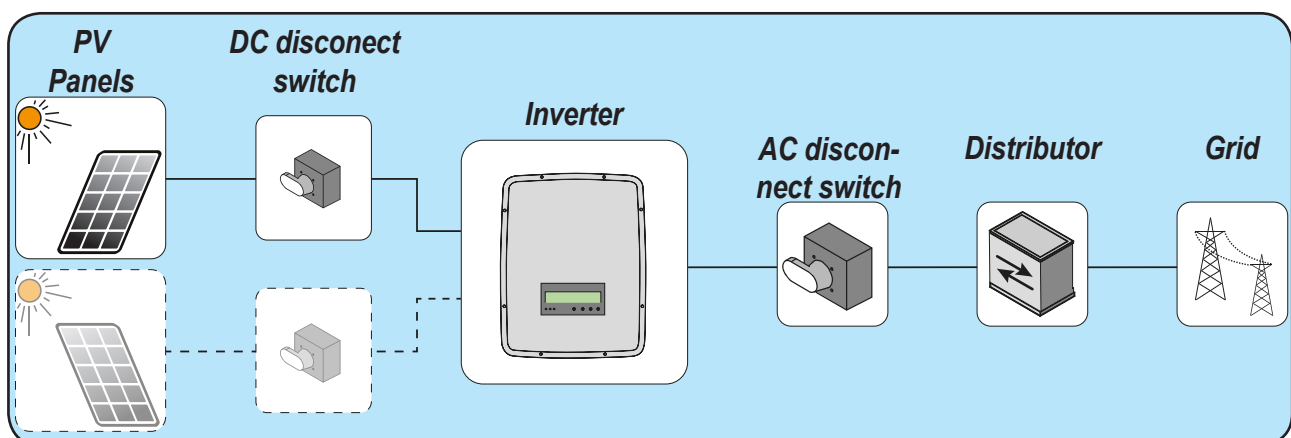

Connection of several inverters together

If the photovoltaic system exceeds the capacity of a single inverter, it is possible to make a multiple connection of inverters to the system, with each one connected to a suitable section of the photovoltaic field, on the DC side, and connected to the grid on the AC side.

Each inverter will work independently of the others and will supply the grid with the maximum power available from its section of photovoltaic panels.



Notes on the sizing of the system

Decisions about how to structure a photovoltaic system depend on a certain number of factors and considerations to make, such as for example, the type of panels, the availability of space, the future location of the system, energy production goals over the long term, etc.

A configuration program that can help to correctly size the photovoltaic system is available on the web site of ABB

Functionality and components of the equipment

Configurable relay

The inverter is equipped with a configurable switching relay, which can be used in different operating configurations that can be set in the dedicated menu. A typical example of application is the activation of the relay in the event of an alarm.

Remote switch-on/switch-off

This command can be used to turn off/turn on the inverter via an external (remote) command.

This functionality must be enabled in the menu and when active, switching on the inverter, besides being dictated by the presence of normal parameters which allow the inverter to be connected to the grid, also depends on the external control for switching on/off.



Reactive power feed into the grid

The inverter is capable of producing reactive power, and then feeding it into the grid through this connection, by setting the phase factor. Managing the input can be controlled directly by the grid company via a dedicated RS485 serial interface or set by the display or through the configuration software, Aurora Manager Lite.

Power feeding modes vary according to the country of installation and the grid companies. For detailed information on the parameters and characteristics of this function, contact **ABB** directly.

Limiting the active power fed into the grid

The inverter, if enabled and set using the display or the Aurora Manager Lite configuration software, can limit the amount of active power fed into the grid by the inverter to the desired value (expressed as a percentage).

Input Fuses

In the -FS version each input is supplied with protection fuses (not factory fitted)  to protect the device from currents exceeding the limit independently for each string.

The sizing of the fuses must be carefully considered during installation.

Data transmission and control

The inverter or a network of several inverters, can also be monitored remotely via an advanced communication system based on a RS-485 serial interface. The range of optional ABB devices that can be connected to this communication line allow you to monitor the device locally or remotely through an internet connection.

Topographic diagram of the equipment

The diagram summarises the internal structure of the inverter.

The main blocks are the DC-DC input converters (called "boosters") and the output inverter. The DC-DC converter and the output inverter both work at a high switching frequency, and so are small and relatively light. Each of the input converters is dedicated to a separate array, with independent maximum power point tracking (MPPT) control.

This means that the two arrays may be installed with various positions or orientations. Each array is controlled by an MPPT control circuit.

The two trackers can be configured (where required) in parallel to handle power levels and/or current higher than those that a single tracker can handle.

This inverter version is of the type without transformer, that is without galvanic insulation between the input and the output. This allows ultimately an increase in conversion efficiency. The inverter is already equipped with all the protections necessary for safe operation and compliance with the norms, even without the insulating transformer.

The inverter is controlled by two independent DSPs (Digital Signal Processors) and a central microprocessor.

The connection to the power grid is thus kept under control by two independent computers, in full compliance with the electric field norms both for power supply to the systems as well as security.

The operating system carries out the task of communicating with its components in order to carry out data analysis.

In doing all this, we guarantee optimal operation of the whole complex and a high performance in all sunlight conditions and always ensuring full compliance with the relevant directives, standards and regulations.



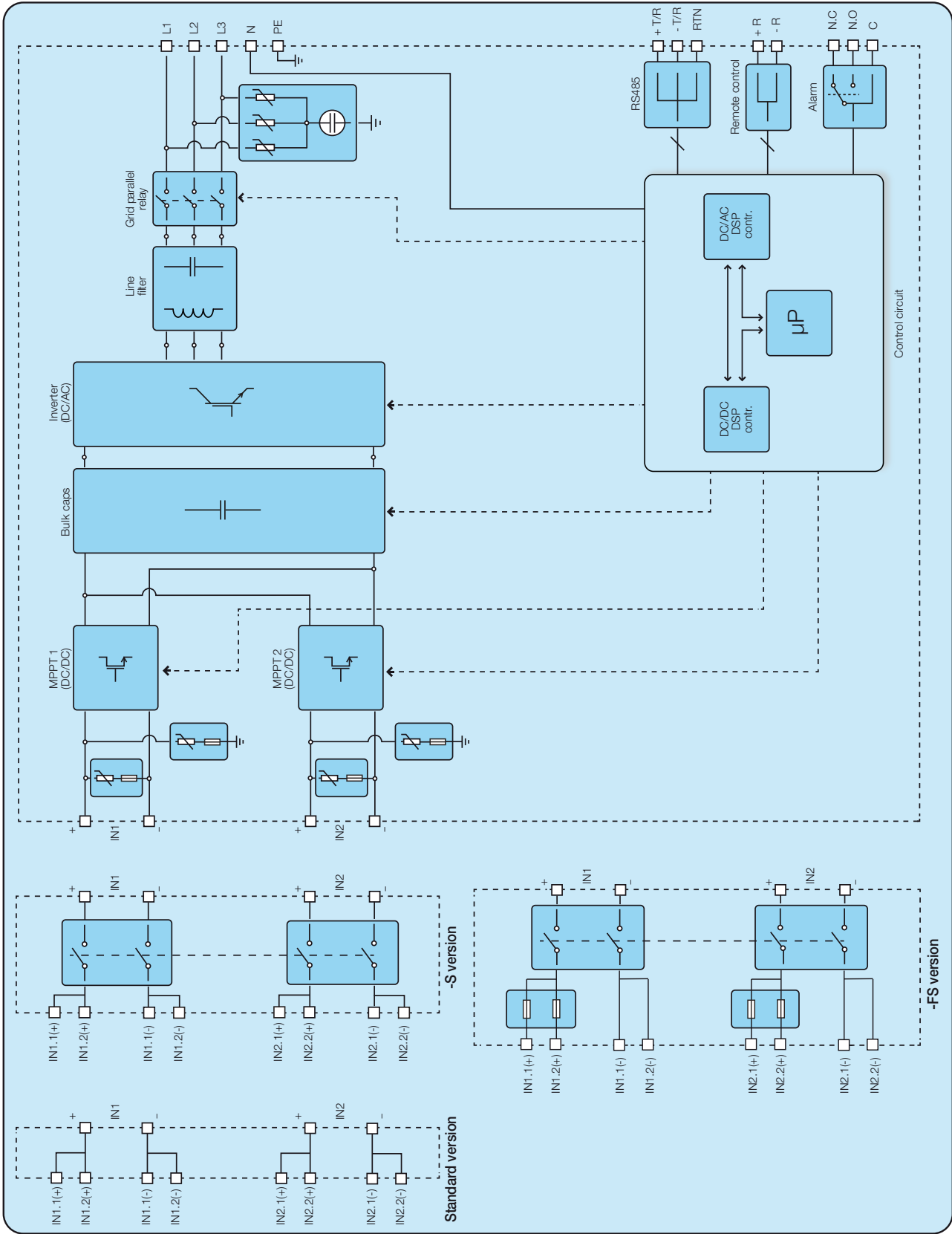

Safety devices

Anti-Islanding

In the event of a local grid outage by the electricity company, or when the equipment is switched off for maintenance operations, the inverter must be physically disconnected to ensure the protection of the people working on the grid, in accordance with the relevant national laws and regulations. To prevent possible islanding, the inverter is equipped with an automatic safety disconnection system called "Anti-Islanding".

Anti-islanding protection mechanisms are different depending on the grid standards, even if they all have the same purpose.

Input Fuses

In the -FS version each input is supplied with protection fuses (not factory fitted)  to protect the device from currents exceeding the limit independently for each string.

The sizing of the fuses must be carefully considered during installation.

Ground fault of the photovoltaic panels

This inverter must be used with panels connected in "floating" mode, i.e. with no earth connections on the positive and negative terminals. An advanced ground fault protection circuit continuously monitors the ground connection and disconnects the inverter when a ground fault indicating the fault condition by means of the red "GFI" LED on the LED panel on the front side.

Other safety devices

The inverter is equipped with additional protective devices to ensure safe operation in any circumstance. These protections include:

- Constant monitoring of the grid voltage to ensure that voltage and frequency values remain within operating limits;
- Internal temperature control to automatically limit the power if necessary to prevent overheating of the unit (derating).

The numerous control systems determine a redundant structure to ensure absolutely safe operations.

Safety information and instructions

The equipment has been manufactured in accordance with the strictest accident-prevention regulations and supplied with safety devices suitable for the protection of components and operators.



For obvious reasons, it is not possible to anticipate the great number of installations and environments in which the equipment will be installed. It is therefore necessary for the customer to appropriately inform the manufacturer about particular installation conditions.

ABB accepts no liability for failure to comply with the instructions for correct installation and cannot be held responsible for the upstream or downstream equipment.



It is essential to provide operators with correct information. They must therefore read and comply with the technical information provided in the manual and in the attached documentation.



The instructions provided in the manual do not replace the safety devices and technical data for installation and operation labels on the product, and they do not replace the safety regulations in force in the country of installation.

The manufacturer is willing to train staff, at its premises or on site, in accordance with conditions agreed to in the contract.



Do not use the equipment if you find any operating anomalies.

Avoid temporary repairs. All repairs should be carried out using only genuine spare parts, which must be installed in accordance with their intended use.

Liabilities arising from commercial components are delegated to the respective manufacturers.

Hazardous areas and operations

Environmental conditions and risks

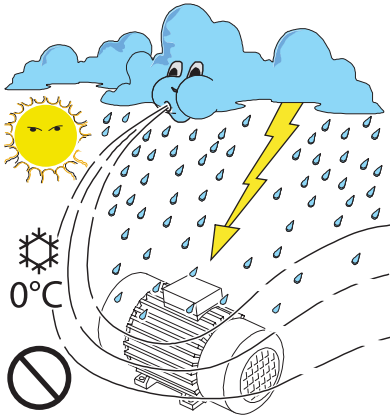

The equipment can be installed outdoors, but only in environmental conditions that do not prevent its regular operation. These conditions are reported on the technical data and on installation chapter.

ABB CANNOT be held responsible for disposal of the equipment: displays, cables, batteries, accumulators, etc., and therefore the customer must dispose of these substances, which are potentially harmful to the environment, in accordance with the regulations in force in the country of installation.

The same precautions should be adopted for dismantling the equipment.



The equipment is not equipped to operate in environments that have particular flammability or explosive conditions.

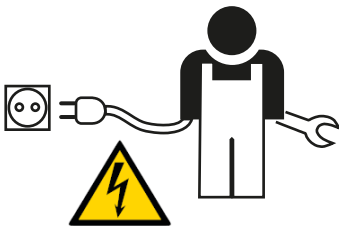

The customer and/or installer must appropriately train operators or anyone who may come near the equipment, and highlight, if necessary with notices or other means, the hazardous areas or operations at risk if required: magnetic fields, hazardous voltages, high temperatures, possibility of discharges, generic hazard, etc.

Signs and Labels



The labels attached to the equipment must absolutely **NOT** be removed, damaged, dirtied, hidden, etc.

The labels must be cleaned regularly and kept visible at all times, that is, they must **NOT** be hidden with objects and extraneous parts (rags, boxes, equipment, etc.)

The technical data shown in this manual do not in any case replace those shown on the labels attached to the equipment.

Thermal hazard

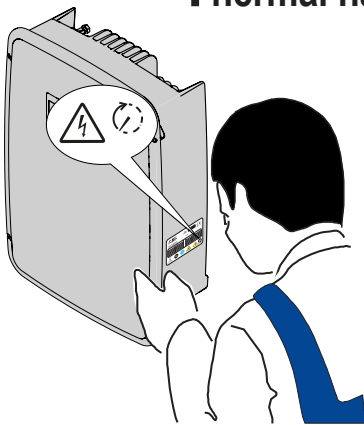

WARNING: removal of guards or covers is allowed only after the voltage has been removed; ; this is to let components cool down and allow any electrostatic charges and parasitic voltages to be discharged.

When the equipment has just been switched, it may have hot parts, as a result of overheating of the surfaces at temperature (e.g.: transformers, accumulators, coils, etc.) so be careful where you touch.

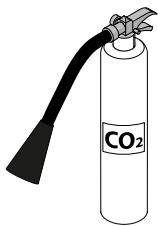

In the event of fire, use CO₂ extinguishers and use auto extraction systems to fight fire in closed environments.



Clothing and protective devices for staff

ABB has eliminated sharp edges and corners, but in some cases it is not possible to do anything, and we therefore advise wearing the clothing and personal protective devices provided by the employer.



Staff must not wear clothes or accessories that can start fires or generate electrostatic charges or, in gener, clothing that can impede personal safety.



All operations on the equipment should be performed with suitably insulated clothes and instruments.

E.g.: Insulated gloves (class 0, category RC)

Maintenance operations must be carried out with the equipment disconnected from the grid and from the photovoltaic generator.

Staff must NOT go near the equipment with bare feet or wet hands.

The maintenance technician must in any case make sure no one else can switch on or operate the equipment during the maintenance operations, and must report any anomaly or damage due to wear or ageing so that the correct safety conditions can be restored.

The installer or maintenance technician must always pay attention to the work environment, so that it is well lit and has sufficient spaces to ensure they have an escape route.



In the installation, consider or make sure the **noise emitted based on the environment** is not such that it exceeds thresholds allowed by law (less than 80 dBA).

Residual risks



Despite the warnings and safety systems, there are still some residual risks that cannot be eliminated.

These risks are listed in the following table with some suggestions to prevent them.

Table of residual risks

| RISK ANALYSIS AND DESCRIPTION | SUGGESTED REMEDY |
|--|---|
|  Noise pollution due to installation in unsuitable environments or where staff work permanently. | Reassess the environment or the place of installation. |
| Suitable local ventilation that does not cause overheating of the equipment and is sufficient not to create discomfort to people in the room. | Restore suitable ambient conditions and air the room. |
| External weather conditions, such as water seepage, low temperatures, high humidity, etc. | Maintain ambient conditions suitable for the system. |
| Overheating of surfaces at temperature (transformers, accumulators, coils, etc.) can cause burns. Also be careful not to block the cooling slits or systems of the equipment. | Use suitable protective equipment or wait for the parts to cool down before switching on the equipment. |
| Inadequate cleaning: compromises cooling and does not allow the safety labels to be read. | Clean the equipment, labels and work environment adequately. |
| Accumulation of electrostatic energy can generate hazardous discharges. | Ensure the devices have discharged their energy before working on them. |
| Inadequate training of staff. | Ask for a supplementary course. |
| During installation, temporarily mounting the equipment or its components may be risky. | Be careful about and disallow access to the installation area. |
| Accidental disconnections of the quick-fit connectors with the equipment in operation, or wrong connections, may generate electric arcs | Be careful about and disallow access to the installation area. |

General conditions

Some recommendation apply only to large size product or multiple small size product packaging.

Transport and handling



Transport of the equipment, especially by road, must be carried out with means for protecting the components (in particular, the electronic components) from violent shocks, humidity, vibration, etc.

During handling, do not make any sudden or fast movements that can create dangerous swinging.

Lifting



ABB usually stores and protects individual components by suitable means to make their transport and subsequent handling easier, but as a rule, it is necessary to utilize the experience of specialized staff in charge of loading and unloading the components.

The ropes and equipment used for lifting must be suitable for bearing the weight of the equipment.

Do not lift several units or parts of the equipment at the same time, unless otherwise indicated.

Unpacking and checking

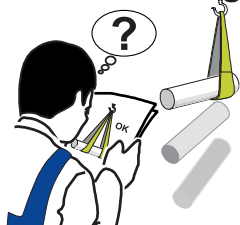
Packaging elements (cardboard, cellophane, staples, adhesive tape, straps, etc.) may cause cuts and/or injuries if not handled with care. They should be removed with the proper equipment.

The components of the packaging must be disposed on in accordance with the regulations in force in the country of installation.

When you open an equipment package, check that the equipment is undamaged and make sure all the components are present. If you find any defects or damage, stop unpacking and consult the carrier, and also promptly inform ABB Service.

List of components supplied

Supplied with the inverter are all the components required to correctly install and connect the inverter

| Components available for all models | | Qty |
|---|---|-------|
|  | Bracket for wall fastening | 1 |
|  | Plugs and screws for wall mounting | 5 + 5 |
|  | D.18 washer | 5 |
|  | M40 Cable Gland | 1 |
|  | M20 Cable Gland | 1 |
|  | Two-hole gasket for M20 signal cable glands and cap | 1 + 1 |
|  | Jumpers for configuration of the parallel input channels | 2 |
|  | Connector for connecting the configurable relay | 2 |
|  | Connector for the connection of the communication and control signals | 2 |
|  | Fuse holder extractors (*only -FS version) | 4 |
|  | Input Fuses 15A / 1000Vdc (*only -FS version) | 4 |
|  | Technical documentation | 1 |

Weight of the groups of device

| Table: Weights | Weight (Kg/lb) | Lifting points (no.#) |
|----------------|--------------------|-----------------------|
| INVERTER | <41.0 kg / 90.4 lb | 4 |

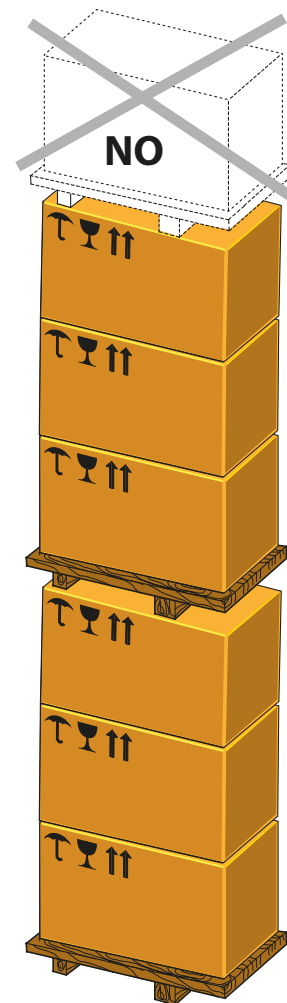
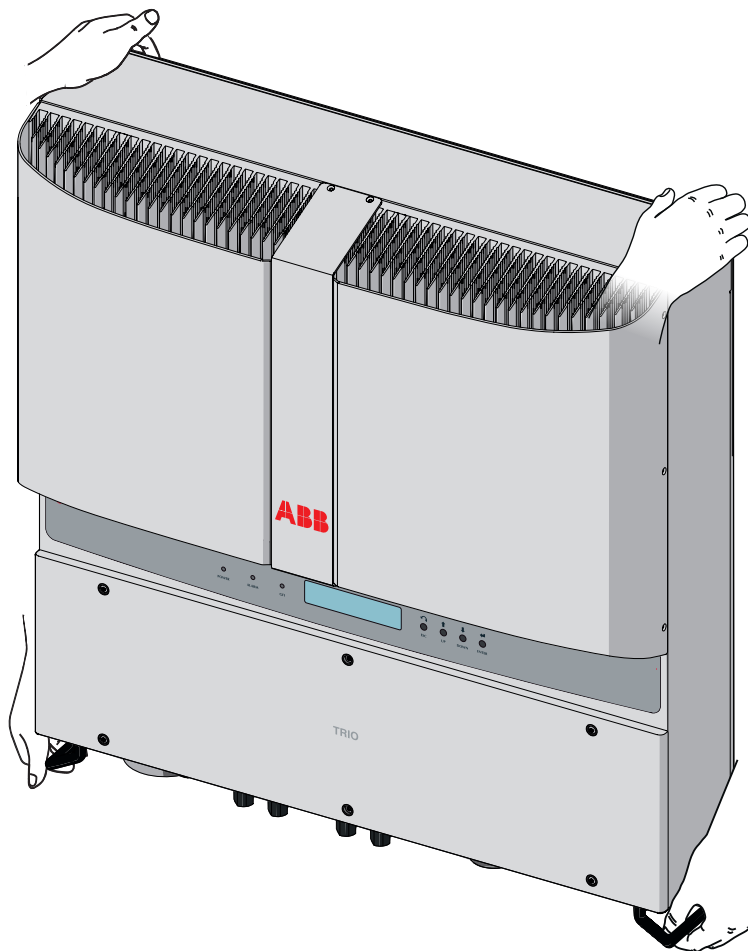

General conditions

Equipment performance will be enhanced by proper equipment installation.

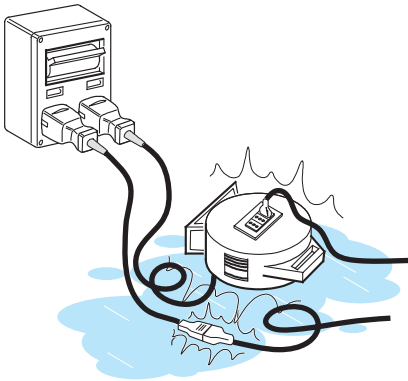

Staff authorized to carry out the installation must have received suitable training on this type of equipment.

Equipment operation must be carried out by staff who comply with instructions in this manual.



For safety reasons only a qualified electrician, who has received training or/and has demonstrated skills and knowledge in operation of this unit, can install this inverter.



The installation is done by qualified installers and/or licensed electricians according to applicable local regulations.



The connection of an inverter energy system to an electrical installation connected to the grid shall be approved by the appropriate electrical distributor.



The installation must be carried out with the equipment disconnected from the grid and from the photovoltaic generator.



When the photovoltaic panels are exposed to light, these supplies a direct current voltage to the inverter.

Environmental checks

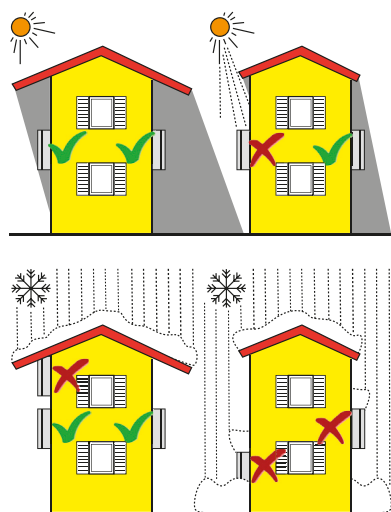

- Consult the technical data to check the environmental parameters to be observed (degree of protection, temperature, humidity, altitude, etc.)
- The installation to direct sunlight must be avoided (otherwise the warranty will be cancelled) because it may cause:
 - phenomena of power limitation by the inverter (with consequent reduction of energy production)
 - premature aging of electronic/electromechanical components
 - premature aging of mechanical components (gaskets) and user interface (display)
- Do not install in small closed rooms where air cannot circulate freely.
- To avoid overheating, always make sure the flow of air around the inverter is not blocked.
- Do not install in presence of flammable materials in the close surroundings (3m minimum distance).
- Do not install on walls made of wood or flammable materials.
- Do not install in rooms where people live or where the prolonged presence of people or animals is expected, because of the noise level that the inverter produces during operation. The level of the sound emission is heavily influenced by where the inverter is installed (for example: the type of surface around the inverter, the general properties of the room, etc.) and the quality of the electricity supply.
- Avoid electromagnetic interference that can compromise the correct operation of electronic equipment, with consequent situations of danger.



The final installation of the inverter should not prevent access to any outside disconnection means. Refer to the warranty conditions to evaluate the possible exclusions from warranty related to improper installation.

Installations above 2000 metres



On account of the rarefaction of the air (at high altitudes), particular conditions may occur that should be considered when choosing the place of installation:

- Less efficient cooling and therefore a greater likelihood of the device going into derating because of high internal temperatures.
- Reduction in the dielectric resistance of the air that, in the presence of high operating voltages (DC input), can create electric arcs (discharges) that can reach the point of damaging the inverter.

As the altitude increases, the failure rate of some electronic components increases exponentially because of cosmic radiation.



All installations at altitudes of over 2000 metres must be assessed case by case considering the aforesaid criticalities.

Installation position

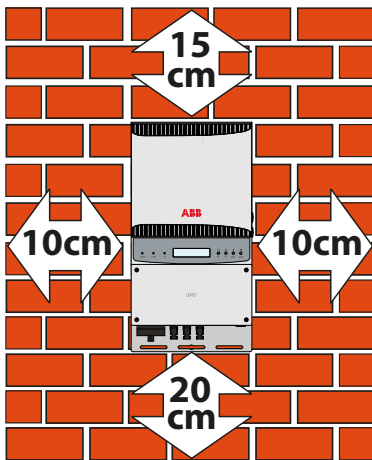
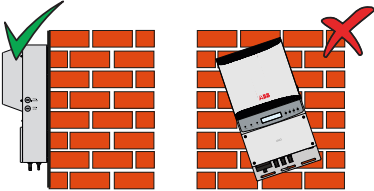
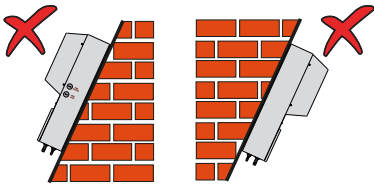

When choosing the place of installation, comply with the following conditions:

- Install on a wall or strong structure suitable for bearing the weight.
- Install in safe, easy to reach places.
- If possible, install at eye-level so that the display and status LEDs can be seen easily.
- Install at a height that considers the heaviness of the equipment. If this condition is not complied with, it can create problems in the event of servicing unless suitable means are provided to carry out the operation.
- Install vertically with a maximum inclination of $\pm 5^\circ$. If this condition is not complied with, the inverter could go into temperature derating because of the worsening of heat dissipation.

- To carry out maintenance of the hardware and software of the equipment, remove the covers on the front. Check that there are the correct safety distances for the installation that will allow the normal control and maintenance operations to be carried out.
- Comply with the indicated minimum distances.

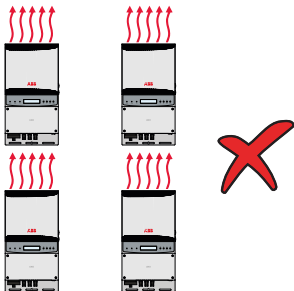
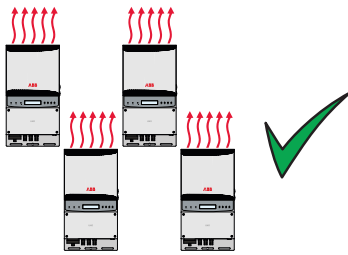

- For a multiple installation, position the inverters side by side.

- If the space available does not allow this arrangement, position the inverters in a staggered arrangement as shown in the figure so that heat dissipation is not affected by other inverters.

Wall mounting

During installation do not place the inverter with the front cover facing towards the ground.

- Position the bracket 01 so that it is perfectly level on the wall and use it as a boring template.

- Make the 3 holes required, using a drill with a 10 mm diameter bit. The depth of the holes should be about 70 mm. On the bracket 01 there are 3 fastening holes.

- Fix the bracket to the wall with the 3 wall anchors, 10mm in diameter, supplied. (Step 1).

- Hook the inverter to the bracket springs in correspondence with the insertion points in the bracket on the back of the inverter (Step 2).

- Drill 2 holes in correspondence with the slots on the inverter lower bracket, using a drill with a 10 mm diameter bit. The holes must be approximately 70 mm deep.

- Anchor the lower part of the inverter using No. 2 plugs with a diameter of 10 mm, supplied (Step 3).

- Unscrew the 6 screws and open the front cover 03 in order to make all the necessary connections.

Do not open the inverter in the case of rain, snow or a high level of humidity (>95%)

- Once the connections have been made, close the cover by tightening the 6 screws on the front to a minimum tightening torque of 1.5 Nm.

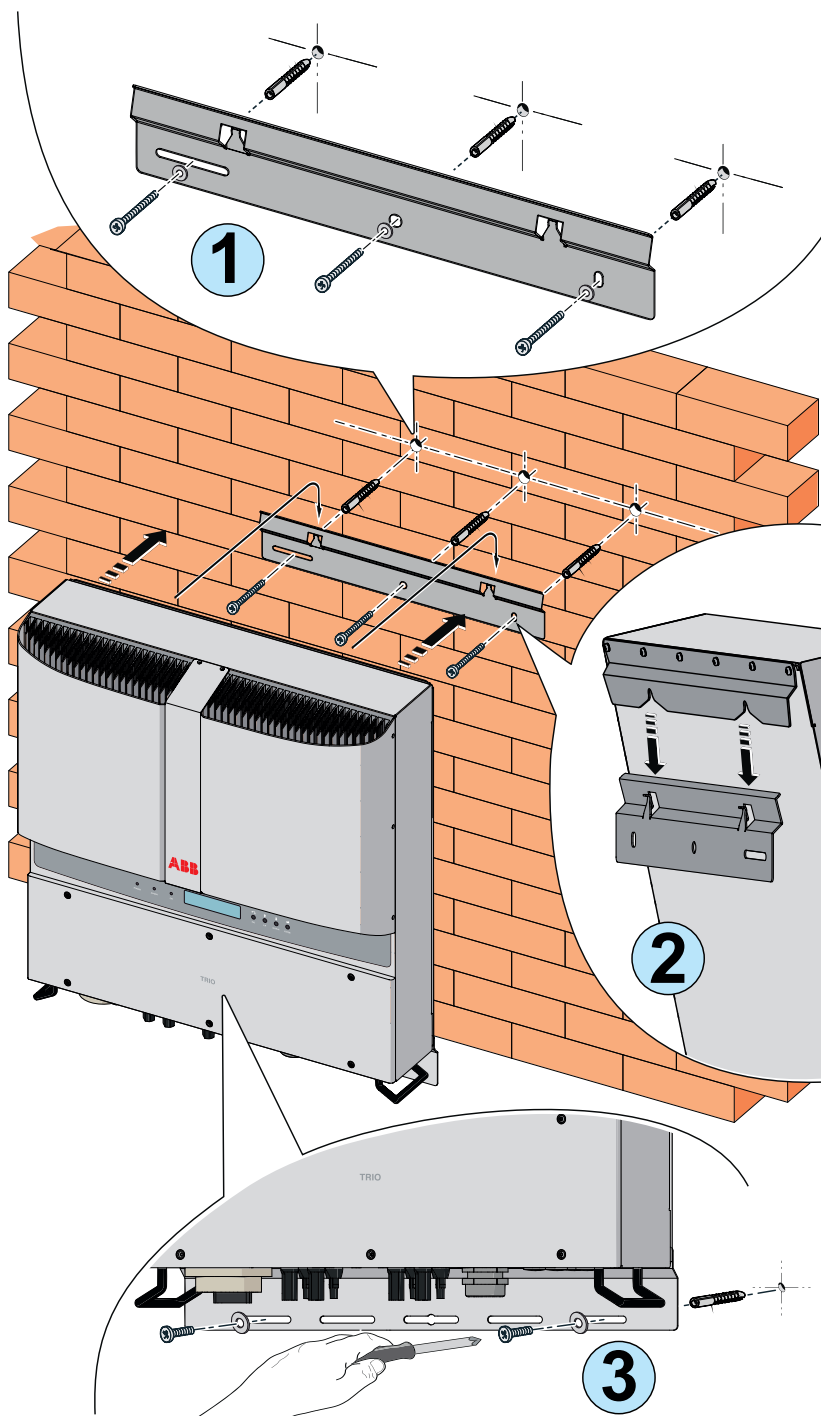

Operations preparatory to PV generator connection

Checking the correct polarity of the strings

Using a voltmeter, check that the voltage of each string observes the correct polarity and falls within the input voltage limits accepted by the inverter (see technical data).



Inversion polarity can cause serious damage

If the voltage without load of the string is near the maximum value accepted by the inverter, it must be borne in mind that with low ambient temperatures the string voltage tends to increase (in a different way according to the photovoltaic module used). In this case, it is necessary to carry out a check of the sizing of the system and/or a check on the connections of the modules of the system (e.g.: number of modules in series higher than the design number).

Checking of leakage to ground of the photovoltaic generator

Measure the voltage present between positive and negative pole of each string with respect to ground.

If a voltage is measured between an input pole and ground, it may be that there is a low insulation resistance of the photovoltaic generator and the installer will have to carry out a check to solve the problem.



Do not connect the strings if a leakage to ground has been found because the inverter might not connect to the grid.

Choice of differential protection downstream of the inverter

All ABB string inverters marketed in Europe are equipped with a device for protection against ground faults in accordance with the safety standard set in Germany by Standard VDE V 0126-1-1:2006-02 (please refer to section 4.7 of the Standard).

In particular, ABB inverters are equipped with a redundancy on the reading of the ground leakage current sensitive to all components of both direct and alternating current. Measurement of the ground leakage current is carried out at the same time and independently by 2 different processors: it is sufficient for one of the two to detect an anomaly to trip the protection, with consequent separation from the grid and stopping of the conversion process.

There is an absolute threshold of 300 mA of total leakage current AC+DC with protection tripping time at a max. of 300 msec.

In addition, there are another three tripping levels with thresholds respectively at 30 mA/sec, 60 mA/sec and 150 mA/sec to cover the “rapid” changes in fault current induced by accidental contact with leaking live

parts. The max. tripping times are progressively shortened as the speed of change in the fault current increases and, starting from the 300 msec/max for the 30 mA/sec change, they are shortened respectively to 150 msec and 40 msec for 60 mA and 150 mA changes.

It should in any case be noted that the integrated device only protects the system against ground faults that occur upstream of the AC terminals of the inverter (namely towards the DC side of the photovoltaic system and consequently towards the photovoltaic modules). The leakage currents that can occur in the AC section between the draw/feed in point and the inverter are not detected and require an external protection device.

For protection of the AC line, on the basis of the aforesaid with regard to the differential protection integrated in ABB inverters, **it is not necessary to install a type B ground fault interrupter.**



In accordance with article 712.413.1.1.1.2 of Section 712 of IEC Standard 64-8/7, we hereby declare that, because of their construction, ABB inverters do not inject ground fault direct currents.



The use of an AC type circuit breaker with differential thermal magnetic protection with tripping current of 300 mA is advisable so as to prevent false tripping, due to the normal capacitive leakage current of photovoltaic modules.

In the case of systems consisting of multiple inverters connected to a single switch with differential protection, it is recommended to install a device that allows the adjustment of the trip value and timing of intervention.



Independent or parallel input channels configuration

All the inverter models are equipped with two input channels (thus benefiting from two trackers for MPPT maximum power point tracking) which work independently of one another, which can be paralleled by leveraging a single MPPT.

Strings of photovoltaic modules having the same type and number of panels in series must be connected to each single channel; they must also have the same installation conditions (in terms of orientation to the SOUTH and inclination from the horizontal plane).

When connecting the two input channels in parallel, you must comply with the above requirements in order to benefit from the ability to leverage the full power of the inverter output on a single channel.

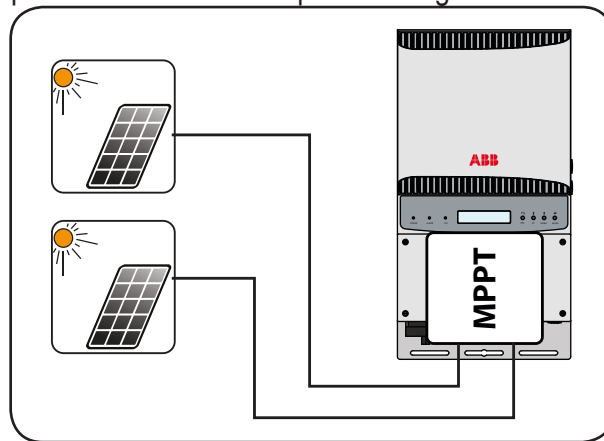

The dual MPPT structure however allows management of two photovoltaic generators which are independent of each other (one for each input channel), and which may differ between themselves with regard to installation conditions, type and number of photovoltaic modules connected in series. A necessary condition for the two MPPT to be used independently is that the photovoltaic generator connected to each of the inputs has a lower power than the power limit of the single input channel and a maximum current lower than the current limit of the single input channel.

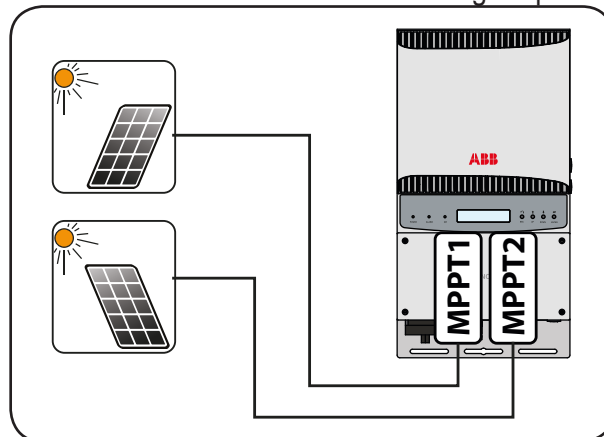

All input parameters that must be met for correct inverter operation are shown in the "technical data" table.

Channel configuration examples

| PV generator characteristics | MPPT configuration | Notes |
|--|--|---|
| <p>The photovoltaic generator consists of strings having a different number of modules in series from each other.</p> <p>The photovoltaic generator consists of strings that have different installation conditions from each other.</p> | <p>MPPT configuration has to be INDEPENDENT</p> | <p>A NECESSARY condition so that the two MPPTs can be used in independent mode is for the photovoltaic generator connected to each of the inputs to have a power lower than the power limit of the single input channel AND a maximum current lower than the current limit of the single input channel.</p> |
| <p>The photovoltaic generator consists of strings having the same number of modules in series as each other.</p> <p>The photovoltaic generator consists of strings that have the same installation conditions, that is to say, all the strings have the same inclination from the horizontal and the same orientation to the SOUTH.</p> <p>The photovoltaic generator connected to each of the inputs has a power lower than the power limit of the input channel AND a current lower than the current limit of the input channel.</p> | <p>Possibility of choosing between the configuration with MPPT as INDEPENDENT or PARALLEL</p> | <p>A NECESSARY condition so that the two MPPTs can be used in independent mode is for the photovoltaic generator connected to each of the inputs to have a power lower than the power limit of the input channel AND a maximum current lower than the current limit of the input channel.</p> <p>An ADVISABLE (*) condition so that the two MPPTs can be connected in parallel is for the photovoltaic generator connected to the two inputs to consist of strings made by the same number of modules in series and for all the modules to have the same installation conditions.</p> |
| <p>(*) <i>This condition is advisable from the point of view of the energy production of the system, not from the point of view of inverter operation.</i></p> | | |
| <p>The photovoltaic generator consists of strings having the same number of modules in series as each other.</p> <p>The photovoltaic generator consists of strings that have the same installation conditions, that is to say, all the strings have the same inclination from the horizontal and the same orientation to the SOUTH.</p> <p>The photovoltaic generator connected to each of the inputs has a power higher than the power limit of the input channel OR a current higher than the current limit of the input channel.</p> | <p>MPPT configuration has to be PARALLEL</p> | <p>A SUFFICIENT (*) condition so that the two MPPTs must be used in parallel mode is for the photovoltaic generator connected to each of the inputs to have a power higher than the power limit of the single input channel OR a maximum current higher than the current limit of the single input channel.</p> <p>An ADVISABLE (**) condition so that the two MPPTs can be connected in parallel is for the photovoltaic generator connected to the two inputs to consist of strings made by the same number of modules in series and for all the modules to have the same installation conditions.</p> |
| <p>(*) <i>This condition is sufficient from the point of view of the energy production of the system, not from the point of view of inverter operation.</i></p> <p>(**) <i>This condition is advisable from the point of view of the energy production of the system, not from the point of view of inverter operation.</i></p> | | |



Independent channel configuration (default configuration)

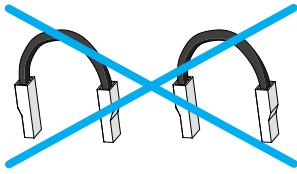

This configuration involves the use of the two input channels (MPPT) in independent mode. This means that the jumpers between the two channels (positive and negative) of the DC input terminal block ⑭ must not be installed and the switch ⑰ located on the main board must be set to “IND”.

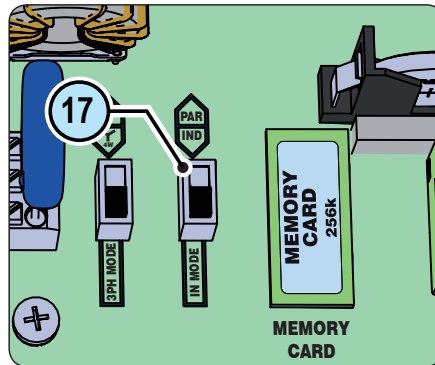

Parallel channel configuration

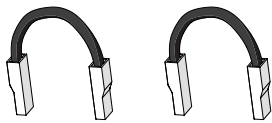

This configuration uses the two input channels (MPPT) connected in parallel. This means that the jumpers between the two channels (positive and negative) of the DC input terminal block ⑭ must be installed and the switch ⑰ located on the main board must be set to “PAR”.

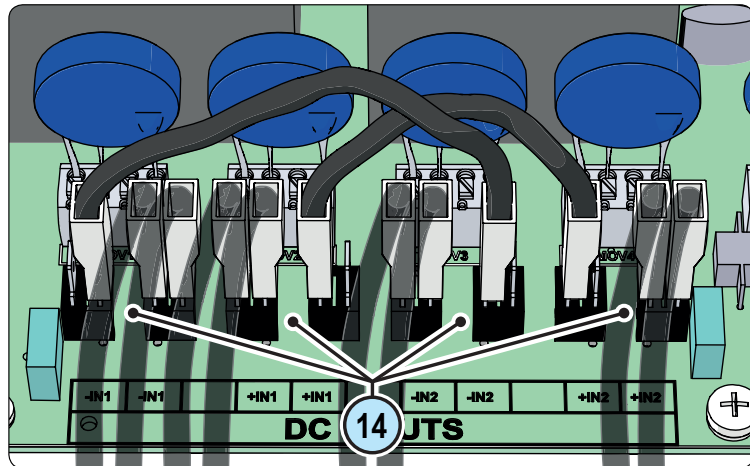
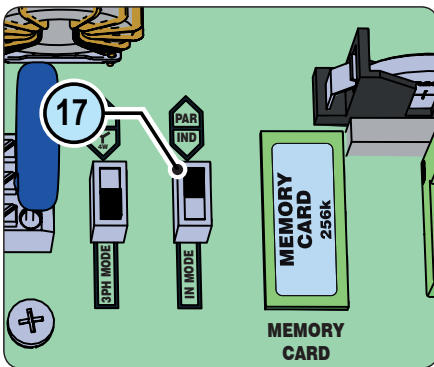

Input connection to PV generator (DC side)

Once preliminary checks have been carried out and no problems found with the photovoltaic system, and the channel configuration has been selected (parallel or independent) you may connect the inputs to the inverter.



According to the system configuration, check the correct setting of the channels to independent or in parallel mode. An incorrect setting of the input channels can lead to loss of energy production.



When the photovoltaic panels are exposed to sunlight they provide continuous DC voltage to the inverter. To avoid risks of electrical shock, all wiring operations must be carried out with the DC disconnect switch (internal or external to the inverter) off.

For the string connections it is necessary to use the quick fit connectors (usually Weidmüller PV-Stick or WM4, MultiContact MC4 and Amphenol H4) located on the bottom of the mechanic ⑨ ⑩.

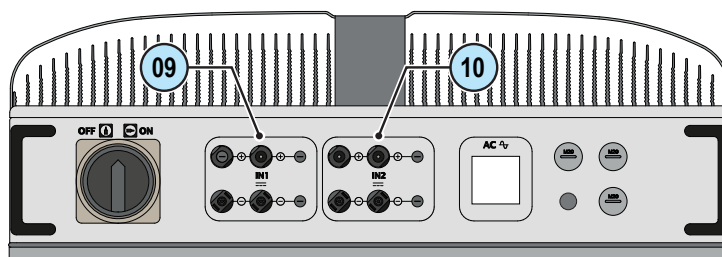

Refer to the document “String inverter – Product Manual appendix” available at www.abb.com/solarinverters to know the brand and the model of the quick fit connector. Depending on the model of the connector of the own inverter, it is necessary to use the same model and the respective counterpart (check the compliant counterpart on the website of the manufacturer or in ABB).



Using corresponding parts that are not compliant with the quick fit connector models on the inverter could cause serious damage to the unit and lead to invalidation of the warranty.

Connect all the strings included in the design of the system, always checking the tightness of the connectors and checking the input polarity is correct.



Polarity inversion can cause serious damage. Check polarity before connecting each string!



In the -FS version you MUST directly connect the individual strings coming into the inverter (do not make field switchboards for parallel strings). This is because the string fuses ⑬, situated on each input, are not sized to take strings in parallel (array). This operation can cause damage to the fuse and consequently malfunctioning of the inverter.



In the -FS version each input is supplied with protection fuses (not factory fitted) and an input polarity control. To check the polarity, connect all the strings and check that the LEDs on the fuse board ⑬ are lit up; if one or more LEDs is off, the polarity of the corresponding strings is to be considered INCORRECT. Once the check has been carried out, DISCONNECT the strings and, checking there is no voltage at the DC inputs, install the protection fuses (supplied) with the aid of fuse holders; reconnect the quick-fit connectors. Check also that the fuse current rating is the correct size for the photovoltaic modules installed. **As long as the check of string polarity, the DC switch must be in OFF position.**

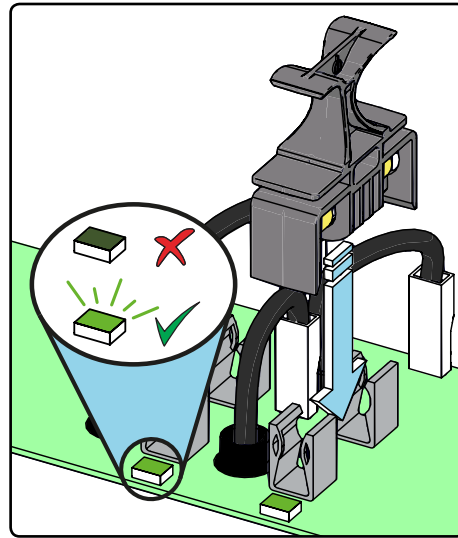
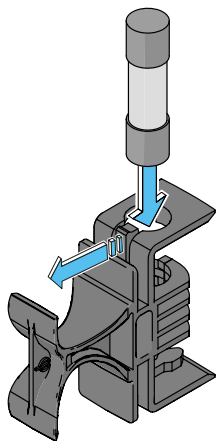

The figure below shows a connection example of the string inputs with dual input channel. Each input channel is connected to a string, while the protective covers are installed to unused connectors.

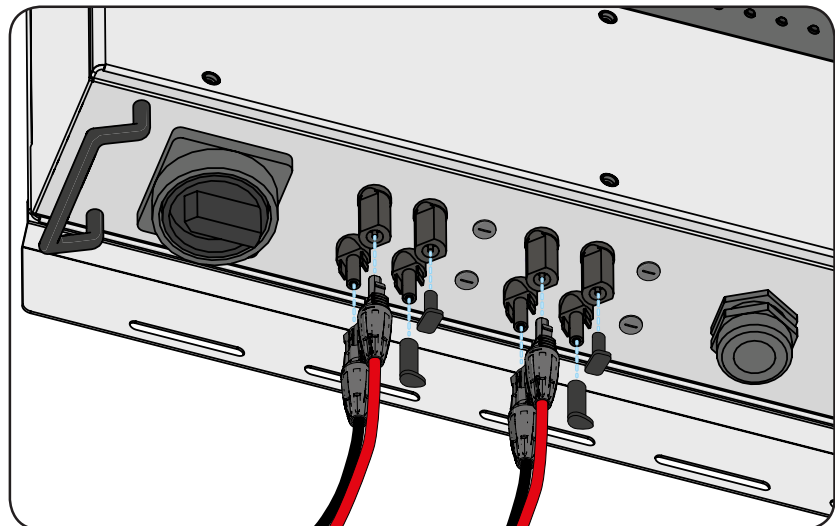

If any string inputs are not required, you must ensure that covers are installed to the connectors, and install any which are missing.

This is necessary both for the inverter seal, and to avoid damage to the free connector which may be used at a later time.

String protection fuses (-FS model only)

Sizing of fuses

Correctly sizing the string fuses ⑬ to be used for protection against return currents is very important since it can significantly reduce the risk of fire and damage to the PV generator. A “return current” can be generated in the event of a fault and relevant short-circuit at the ends of one or more PV modules of the system; this condition can cause all the current supplied by the strings not involved in the fault, but connected to the same input channel, to pass through the faulty string.

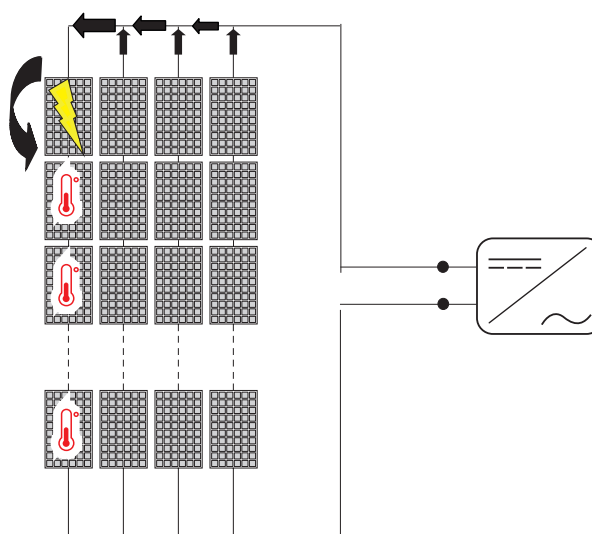

The following 2 conditions must be taken into account when sizing the string fuses ⑬:

1. The current rating of the fuse (I_{rated}) may not exceed the maximum rating of the fuse to be used in series with the string (maximum series fuse rating), specified in the technical data of the PV modules, in agreement with standard IEC 61730-2

$$I_{rated} < \text{Maximum series fuse rating}$$

2. The rating of the fuse (I_{rated}) must be determined according to the string current and the manufacturer's sizing guidelines in order to avoid unforeseen failures. As a general guide, based on the short-circuit current (I_{sc}) of the PV modules, the fuse rating may be calculated from the following formula:

$$I_{rated} > (1,4 \approx 1,5) \cdot I_{sc}$$

The fuse selected must be the standard commercial size closest to the result obtained.

The fuse selected according to the formula described above must take into account adjustments and derating factors such as:

- Increase in the effective incident radiation at the installation site
- Increase in I_{sc} as a result of high temperature in the PV module
- Thermal derating of the fuse
- Maximum return current of the installed PV modules

ABB can supply fuse kits of different values

| Code | Description | Quantity |
|------------------|------------------|----------|
| KIT 10 FUSES 8A | Kit of 8A fuses | 10 |
| KIT 10 FUSES 10A | Kit of 10A fuses | 10 |
| KIT 10 FUSES 12A | Kit of 12A fuses | 10 |
| KIT 10 FUSES 15A | Kit of 15A fuses | 10 |



For effective calculation taking real installation conditions into account, refer to the documents supplied by the fuse manufacturer.



Installation procedure for quick fit connectors

There are typically four different types of quick-fit connector models used on ABB inverters: Weidmüller PV-Stick or WM4, MultiContact MC4 and Amphenol H4.

Refer to the document “String inverter – Product Manual appendix” available at www.abb.com/solarinverters to know the brand and the model of the quick fit connector.

The model of connectors installed on your inverter must be matched by the same model of the respective corresponding parts to be used (checking the conforming corresponding part on the manufacturer’s website).



Using corresponding parts that are not compliant with the quick fit connector models on the inverter could cause serious damage to the unit and lead to invalidation of the warranty.



CAUTION: To avoid damage to the equipment, when attaching cables, pay particular attention to polarity.

1. WEIDMÜLLER PV-Stick quick fit connectors

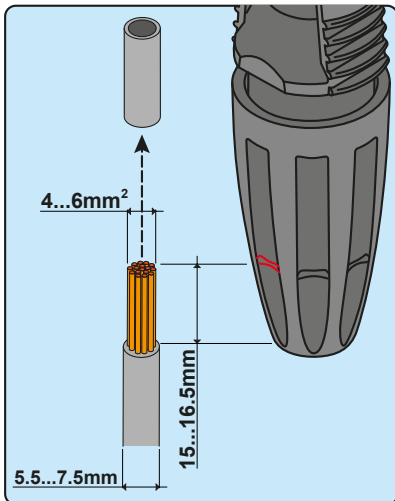

Installation of Weidmüller connectors does not require any special tooling.

- Strip the cable to which you want to apply the connector (after verifying that it complies with the connector limits)

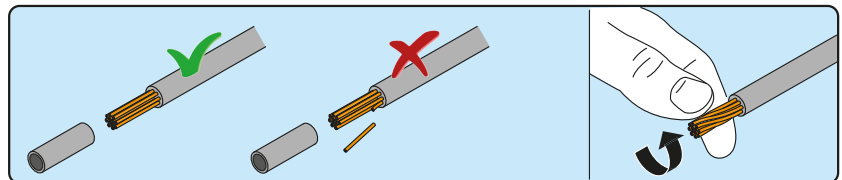

- Insert the wire into the connector until you hear a locking “click”

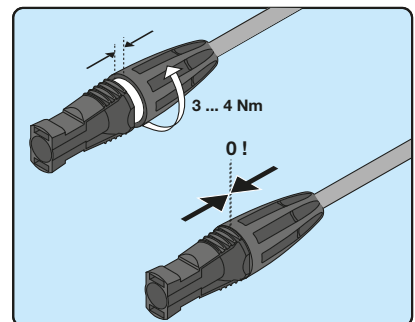
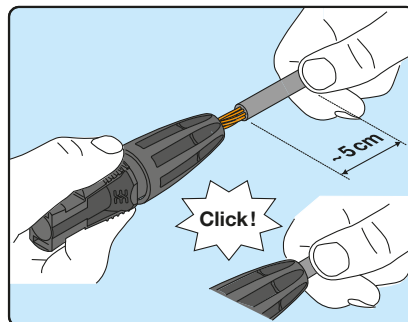

- Tighten the knurled ring nut for optimal clamping

2. WEIDMÜLLER WM4 quick fit connectors

Installation of Weidmüller WM4 connectors requires crimping to be carried out with suitable equipment.

- Strip the cable to which you want to apply the connector (after verifying that it complies with the connector limits).

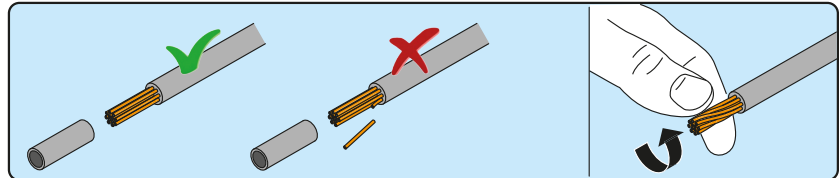
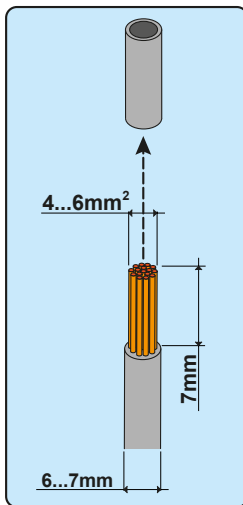

- Apply the terminal to the conductor using suitable crimping pliers.

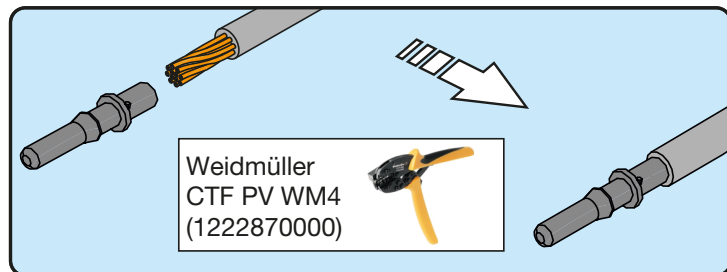

- Insert the cable with the terminal into the interior of the connector, until you hear the click indicating that the terminal is locked inside the connector.

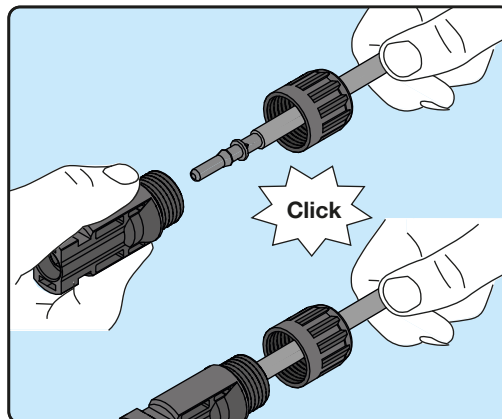

- Firmly tighten the cable gland using the relevant tool to finish the operation.

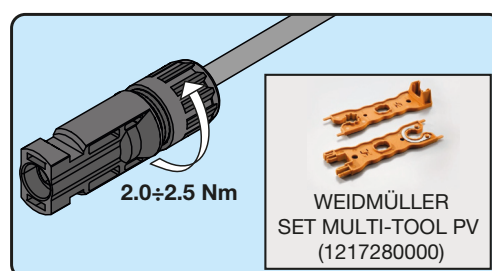

3. MULTICONTACT MC4 quick fit connectors

Installation of Multicontact MC4 connectors requires crimping to be carried out with suitable equipment.

- Strip the cable to which you want to apply the connector (after verifying that it complies with the connector limits).

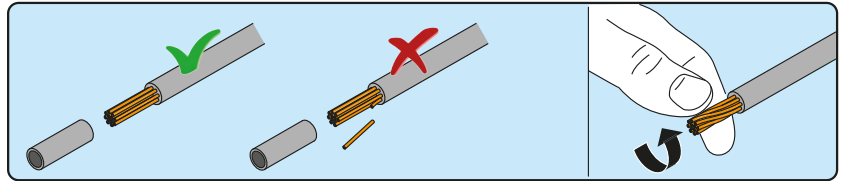
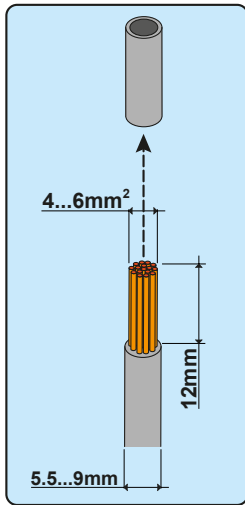

- Apply the terminal to the conductor using suitable crimping pliers.

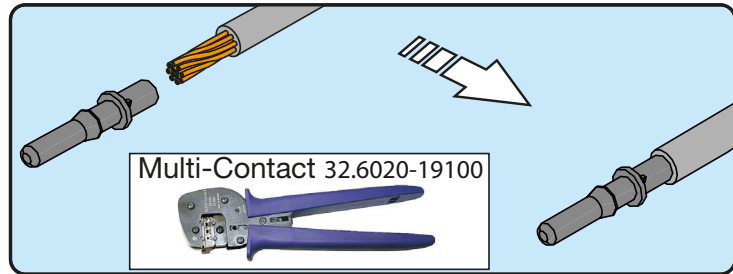

- Insert the cable with the terminal into the interior of the connector, until you hear the click indicating that the terminal is locked inside the connector.

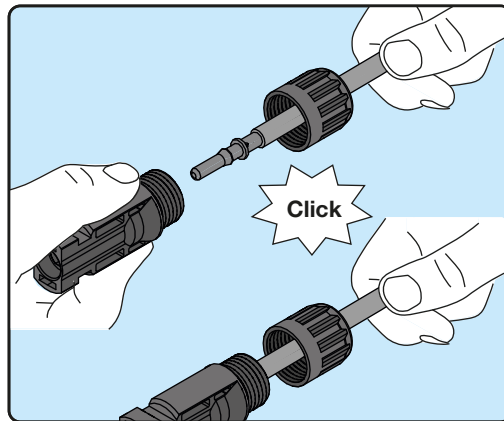

- Firmly tighten the cable gland using the relevant tool to finish the operation.

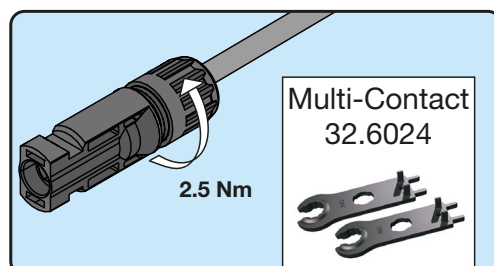

4. AMPHENOL H4 quick fit connectors

Installation of Amphenol H4 connectors requires crimping to be carried out with suitable equipment.

- Strip the cable to which you want to apply the connector (after verifying that it complies with the connector limits).

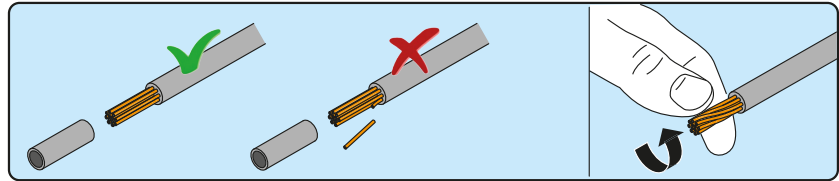
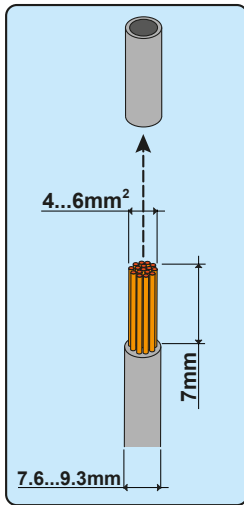

- Apply the terminal to the conductor using suitable crimping pliers.

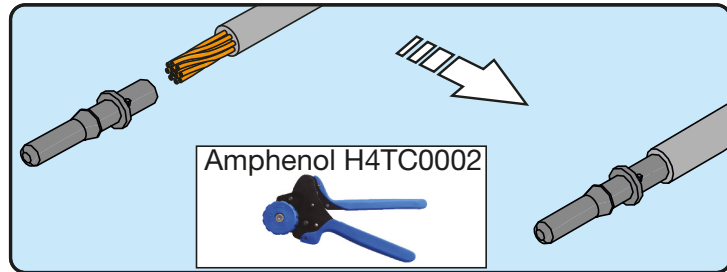

- Insert the cable with the terminal into the interior of the connector, until you hear the click indicating that the terminal is locked inside the connector.

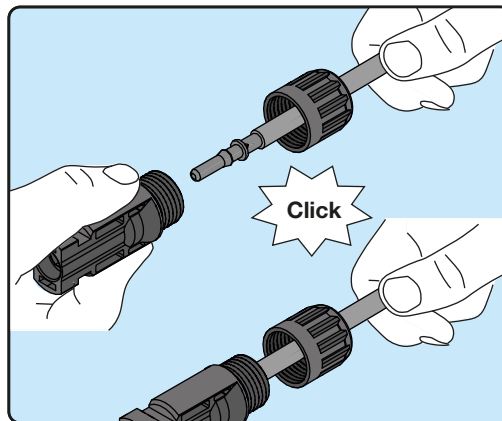

- Firmly tighten the cable gland using the relevant tool to finish the operation.

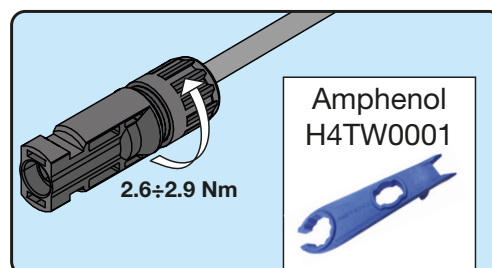

Grid output connection (AC side)

For the connection of the inverter to the grid, you can choose between a star connection (3 phases + neutral) and a delta connection (3 phases).



In case of an isolation transformer is installed in the energy plant, it's mandatory to use the star configuration for the LV winding of isolation transformer (inverter side) with the center of star (neutral) referred to the ground.

In any case, connection of the inverter to ground is mandatory.



Any failure of the inverter when it is not connected to earth through the appropriate terminal is not covered by the warranty.

Plug the grid cable into the inverter using the specific AC cable gland ¹¹ and connect the AC output screw terminal block ¹⁵.

Use a properly sized 5-pole cable (star configuration) or 4-pole cable (delta configuration) cable and check the tightness of the AC cable gland ¹¹ at the end of the installation.



Characteristics and sizing of the line cable

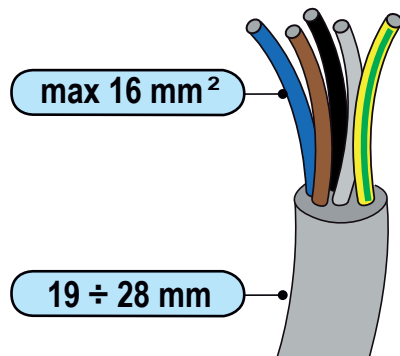

The cross-section of the AC line conductor must be sized in order to prevent unwanted disconnections of the inverter from the grid due to high impedance of the line that connects the inverter to the power supply point; In fact, if the impedance is too high, it causes an increase in the AC voltage that, on reaching the limit set by the country of installation, causes the inverter to switch off.

The table shows the maximum length of the line conductor based on the cross-section of this conductor:

| Cross-section of the line conductor (mm ²) | PVI-10.0-TL-OUTD | PVI-12.5-TL-OUTD |
|--|------------------|------------------|
| 4 mm ² | 34 m | 28 m* |
| 6 mm ² | 51 m | 42 m |
| 10 mm ² | 85 m | 70 m |
| 16 mm ² | 136 m | 113 m |

*Up to 45 °C Ambient temperature

The values are calculated in nominal power conditions, considering:

- loss of power along the line no greater than 1%.
- use of copper cable, with HEPR rubber insulation and positioned in open air.

Load protection switch (AC disconnect switch)

To protect the AC connection line of the inverter, we recommend installing a device for protection against over current and leakage with the following characteristics:

| | PVI-10.0-TL-OUTD | PVI-12.5-TL-OUTD |
|------------------------------------|---|------------------|
| Type | Automatic circuit breaker with differential thermal magnetic protection | |
| Voltage rating | 400 Vac | |
| Current rating | 20 A | 25 A |
| Magnetic protection characteristic | B/C | |
| Type of differential protection | A/AC | |
| Differential sensitivity | 300 mA | |
| Number of poles | 3/4 | |

Connection to the AC side terminal board



To prevent electrocution hazards, all the connection operations must be carried out with the disconnect switch downstream of the inverter (grid side) open and locked.

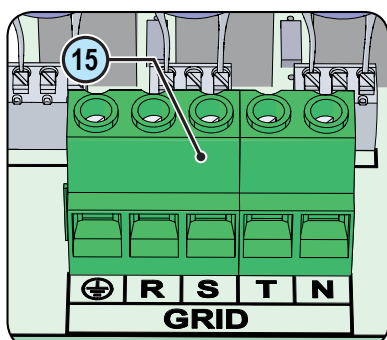

For all inverter models, connection is carried out using the AC output terminal block ⑮ passing the cables internally through the AC cable gland ⑪.

Remove the protective film located on the hole to be used for the AC cables ⑪, insert the M40 cable gland in the hole and secure it using the M40 lock nut (to ensure environmental protection IP65 it is necessary to fix the cable gland to the inverter chassis with a minimum tightening torque of 8.0 Nm).

Strip 10 mm of sheathing from the AC grid connection cables then plug the AC line cable into the inverter, passing it through the previously installed cable gland; the maximum diameter accepted by the cable gland is from 19 to 28 mm².

Connect on the terminal block ⑮ the protective earth (yellow-green) cable to the contact labelled with the ⊕ symbol, the phases cables to the terminals labelled with the letters **R S T** and in case of star connection, connect the neutral cable (normally blue) to the terminal labelled with the letter **N**.

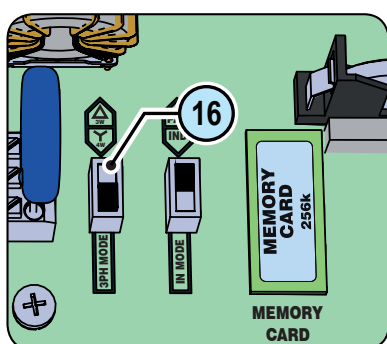

Each terminal of the terminal block accepts a cable with cross-section which can vary from 0.6 up to 16 mm² (The AC cables must be tightened on the terminal block with a minimum torque of 1.5 Nm). **Pay special attention and ensure you do not reverse any phases with the neutral!**

N.B.: When connecting to the AC grid in “delta” configuration (without neutral wire) turn the grid type selection switch ⑯ with the screen-printed marking “3PH MOD” and set it to “3W Δ”.

Once the connection to the terminal board has been made, tighten the cable gland firmly (tightening torque 5.0Nm) and check the seal.

Communication and control board

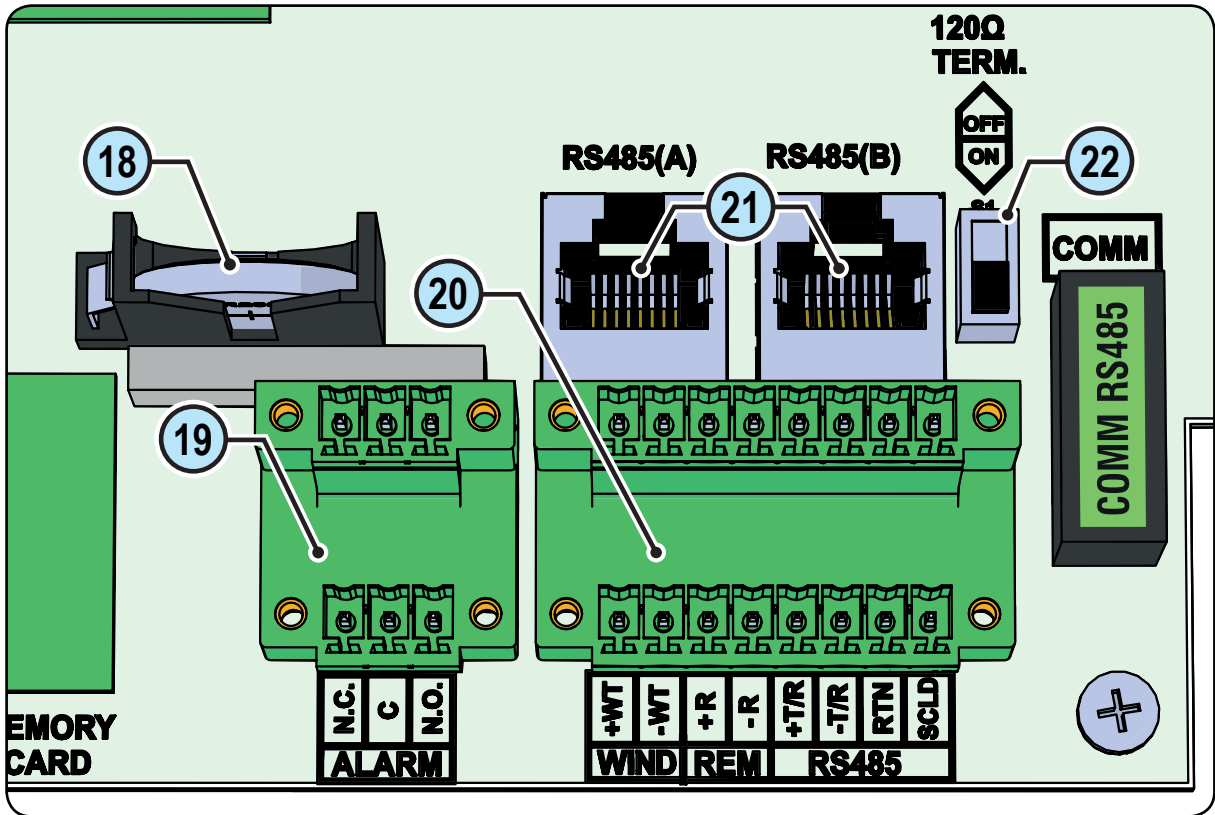

| Ref. inverter | Ref. manual | Description |
|---------------|-------------|---|
| ALARM | ⑰ | Connection to the multi-function relay |
| WIND | ⑳ | Connection of the Tachometer signal |
| REM | ⑳ | Connection to the remote ON/OFF |
| RS485 | ⑳ | Connection of the RS485 line |
| RS485 (A) | ㉑ | Connection of the RS485 line on RJ45 connector |
| RS485 (B) | ㉑ | Connection of the RS485 line on RJ45 connector |
| 120 Ω TERM. | ㉒ | RS485 line termination resistance selector switch |

Connections to the communication and control board

Each cable which must be connected to the communication and control board must pass through one of the three service cable glands M20 ⑫, which take a cable with a diameter of 7 mm to 13 mm. Gaskets with two holes are supplied as standard to insert into the cable gland, which enables two separate cables of a maximum cross-section of 5 mm to be accommodated.

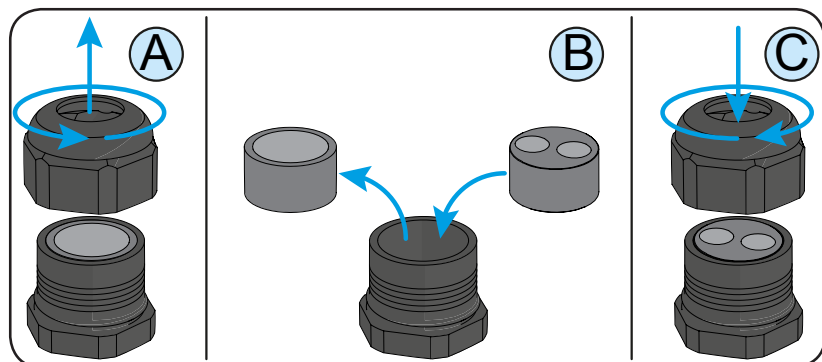
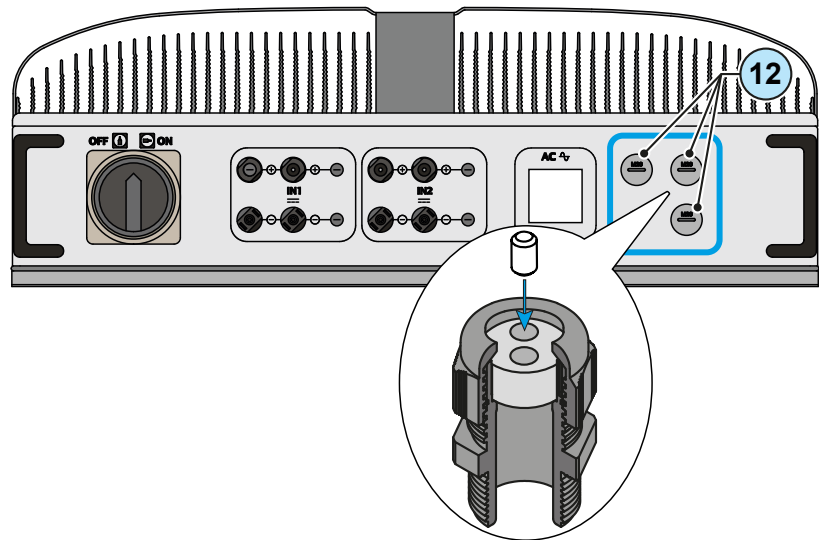

Serial Connection Communication (RS485)

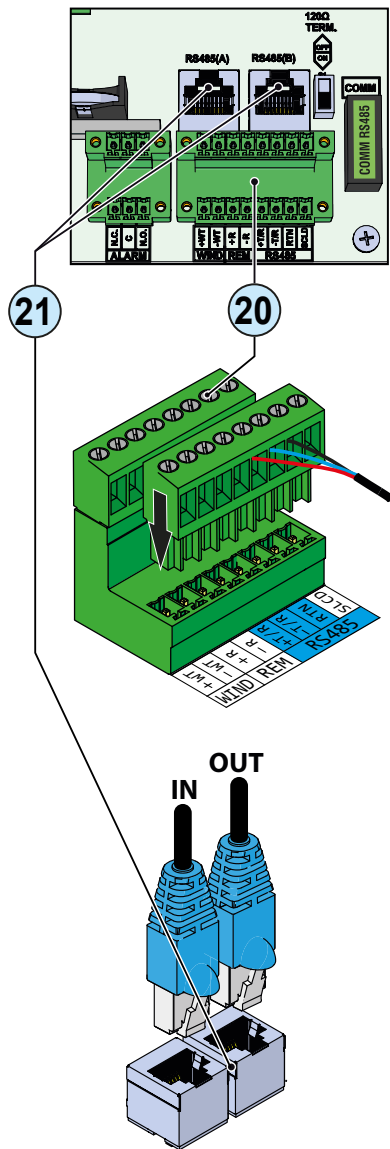

On the inverter there is a RS485 communication line, dedicated to connecting the inverter to monitoring devices or to carrying out “daisy-chain” (“in-out”) connections of multiple inverters. The line may also be used to store settings with the dedicated advanced configuration software.

Cables connecting the RS485 line may use two different types of connection:

- **Connection of the conductors using the terminal connectors ②0 (+T/R, -T/R, SLCD and RTN)**

The SLCD connection must be used for connecting the shielding boot(s) of the cable(s).

- **Connection of conductors with RJ45 connectors ②1**

The two RJ45 connectors RS485(A) and RS485(B) available for the RS485 communication, are equivalent to each other and can be used interchangeably for the arrival or for the output of the line in realising the daisy chain connection of the inverters.

The same is true for connections made using the terminal connectors ②0.



Table: crimping diagram for RJ45 connectors

| Pin No. | Function |
|------------|----------|
| 3 | +T/R |
| 4 | +R |
| 5 | -T/R |
| 7 | RTN |
| 1, 2, 6, 8 | not used |

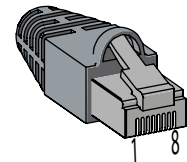

Use a connector with metal body to provide cable shield continuity!

For long distance connections, the connection on terminal connector is preferable using a shielded twisted pair cable with characteristic impedance of $Z_0=120$ Ohm like the one shown on the following table:

| | Signal | Symbol |
|--|----------------|--------|
| | Positive data | +T/R |
| | Negative datum | -T/R |
| | Reference | RTN |
| | Shield | SLCD |



Shield continuity must be provided along the communication line using the SLCD terminal and must be grounded at a single point.

Procedure for connection to a monitoring system

Connect all the units of the RS485 chain in accordance with the “daisy-chain” arrangement (“in-out”) observing the correspondence between signals, and activate the termination resistance of the communication line in the last element of the chain by switching switch 22 (to ON position).

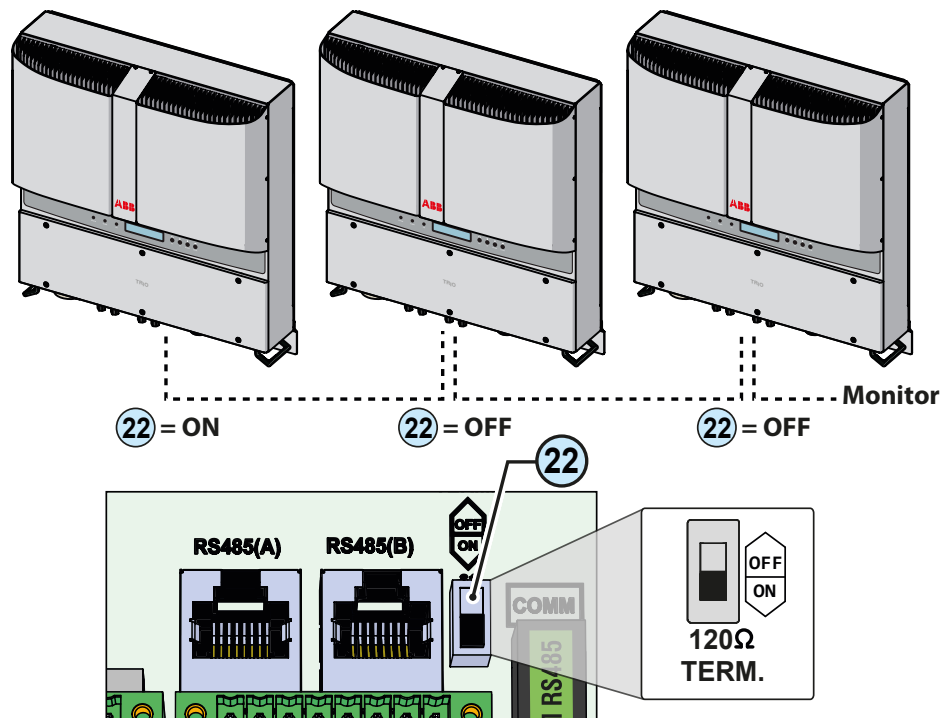

If a single inverter is connected to the monitoring system, activate the termination resistance of the communication line by switching switch 22 (to ON position).

Set a different RS485 address on each inverter of the chain. **No inverter should have “Auto” as its address.** An address can be chosen freely from out of 2 to 63.

The address on the inverter is set through the display and the push-button panel (see relevant chapter).



*We recommend not exceeding a length of 1000m for the communication line.
No more than 62 inverters can be connected to the same RS485 line.*

When using an RS485 connection, if one or more inverters are added later to the system, you must remember to return to OFF position the switch of the termination resistance used of the inverter that was previously the last one of the system.

Each inverter is dispatched with two (2) as the predefined RS485 address and with switch for setting termination resistance 22 to OFF position.

Remote control connection

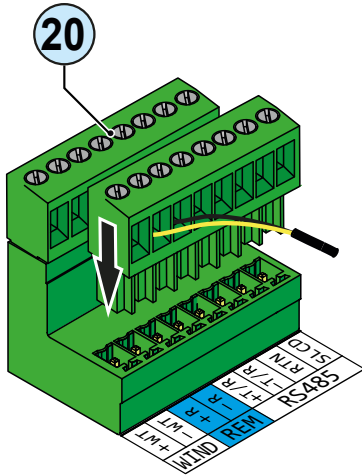
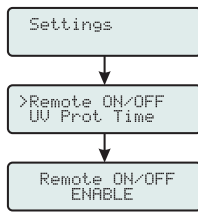

The connection and disconnection of the inverter to and from the grid can be controlled through an external control.

The function must be enabled in the relevant menu. If the Remote control function is disabled, the switching on of the inverter is dictated by the presence of the normal parameters that allow the inverter to connect to the grid.

If the Remote control function is operating, besides being dictated by the presence of the normal parameters that allow the inverter to connect to the grid, the switching ON of the inverter also depends on the state of the **R+** terminal compared to the **R-** terminal present on the connector 20.

When the **R+** signal is brought to the same potential as the **R-** signal (i.e. by making a short circuit between the two terminals of the connector), this causes the inverter to disconnect from the grid.

The remote control OFF condition is shown on the display.

The connections of this control are made between the "R+" input and "R-". Since this is a digital input, there are no requirements to be observed as regards cable cross-section (it only needs to comply with the sizing requirement for passing cables through the cable glands and the terminal connector).



Configurable Relay connection (ALARM)

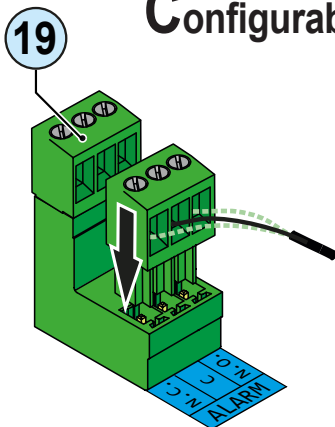

The inverter is equipped with a multifunction relay with configurable activation. It can be connected with normally open contact (being connected between the N.O. terminal and the common contact C.) and with normally closed contact (being connected between the N.C. terminal and the common contact C.).

Different types of devices (light, sound, etc.) can be connected to the relay, provided they comply with the following requirements:

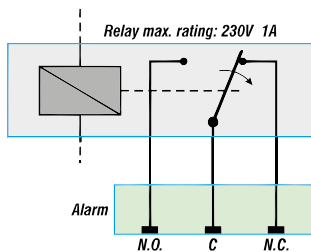

Relay Ratings

Maximum Voltage: 230 Vac

Maximum Current: 1 A

Cable requirements

External diameter: from 5 to 17 mm

Conductor cross-section: from 0.14 to 1.5 mm²

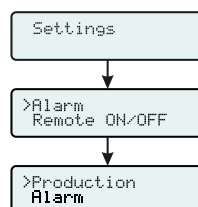

This contact can be used in different operating configurations that can be selected by accessing the "SETTINGS → Alarms" menu.

General conditions

One of the first rules for preventing damage to the equipment and to the operator is to have a thorough knowledge of the instruments. We, therefore, advise that you carefully read this manual. If you are not sure about any information in this manual, please ask ABB Service for more detailed information.



Do not use the equipment if:

- you do not have suitable qualifications to work on this equipment or similar products;*
- you are unable to understand how it works;*
- you are not sure what will happen when the buttons or switches are operated;*
- you notice any operating anomalies;*
- there are doubts or contradictions between your experience, the manual and/or other operators.*

ABB cannot be held responsible for damage to the equipment or the operator if it is the result of lack of knowledge, insufficient qualifications or lack of training.

Description of keyboard and LED Panel

Using the combination of keyboard keys, under the display, it is possible to set values or scroll through the data items to view them. LED indicators are located alongside the keyboard, indicating the operating state of the inverter.

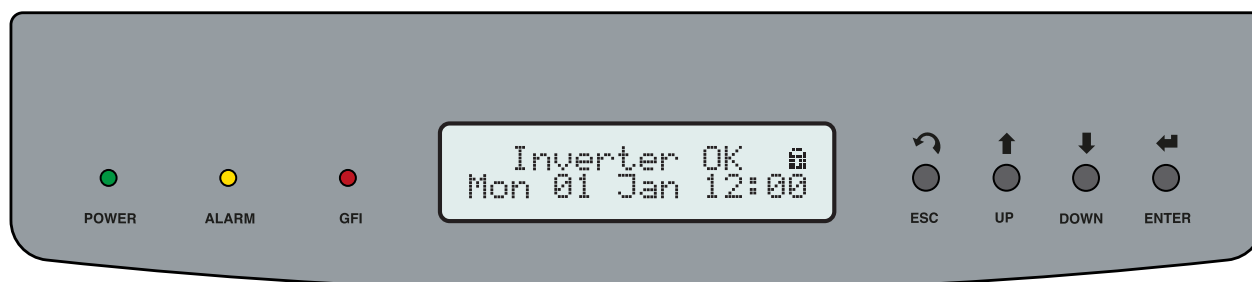

| LED | Description |
|-----------------------|--|
| POWER (GREEN) | ON if the inverter is working correctly. Flashes when checking the grid or if there is insufficient sunlight. |
| ALARM (YELLOW) | The inverter has detected an anomaly; the anomaly is shown on the display. |
| GFI (RED) | Ground fault on the DC side of the PV generator; the error is shown on the display. |

The LEDs, in various multiple available combinations, can signal multiple conditions other than the original single condition; see the various descriptions explained in the manual.



| KEYS | Description |
|--------------|--|
| ESC | It is used to access the main menu, to go back to the previous menu or to go back to the previous digit to be edited. |
| UP | It is used to scroll up the menu options or to shift the numerical scale in ascending order. |
| DOWN | It is used to scroll down the menu options or to shift the numerical scale in descending order. |
| ENTER | It can be used to confirm an action, to access the submenu for the selected option (indicated by the > symbol) or to switch to the next digit to be edited. By pressing and holding the key, the cyclical display of the parameters can be: Locked or Cyclical . |

The Keys, in various multiple available combinations, allow you to access actions other than the original single action; see the various descriptions explained in the manual.



General conditions

Before checking the operation of the equipment, it is necessary to have a thorough knowledge of the Instruments chapter 6 and the functions that have been enabled in the installation process.

The equipment operates automatically without the aid of an operator; the operating state should be controlled through the equipment's instrumentation.

The interpretation or variation of some data is reserved exclusively for specialized and qualified staff.



*The incoming voltage must not exceed the maximum values shown in the technical data, section 2 in order to avoid damaging the equipment.
Consult the technical data for further details.*

During operation, check that the environmental and logistical conditions are correct (see installation chapter 5).

Make sure that environmental and logistical conditions have not changed over time and that the equipment is not exposed to adverse weather conditions.

Monitoring and data transmission

As a rule, the inverter operates automatically and does not require special checks. When there is not enough solar radiation to supply power for export to the grid (e.g. during the night), it disconnects automatically and goes into stand-by mode.

The operating cycle is automatically restored when there is sufficient solar radiation. At this point, the luminous LEDs on the LED panel will indicate this state.

User interface mode

The inverter is able to provide information about its operation through the following instruments:

- Warning lights (luminous LEDs)
- LCD display for displaying operating data
- Data transmission on the dedicated RS-485 serial line. Data may be collected by a PC or a data logger with an RS-485 port. Contact the ABB support service with any queries about device compatibility.

Types of data available

The inverter provides two types of data, which can be retrieved through the special interface software and/or the display.

Real-time operating data

Real-time operating data can be transmitted on request through the communication lines and are not recorded in the inverter.



Internally stored data

The inverter internally stores a set of data that are necessary for processing statistical data and an error log with time marking.

Measurement tolerance

The data supplied by the inverter may differ from measurements taken by certified measuring instruments (e.g. output meters, multimeters and grid analysers); since the inverter **is not a measuring instrument** it has wider tolerances for the measurements it makes.

The tolerances are generally:

- ±5% for real-time measurements with output power below 20%
- ±3% for real-time measurements with output power above 20%
- ±4% for all statistical data

Commissioning



Do not place objects of any kind on the inverter during operation! Do not touch the heat sink while the inverter is operating! Some parts may be very hot and could cause burns.



Before proceeding with commissioning, make sure you have carried out all the checks and verifications indicated in the section on preliminary checks.

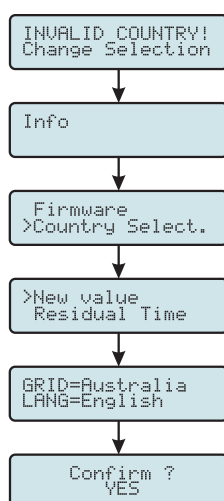

The procedure for commissioning the inverter consists of the following steps:

- Move the integrated switch ⑧ (version -S and -FS) to the ON position or close the external switches: If the input voltage applied to one of the two input channels is greater than the minimum starting voltage, the inverter will start up.
- When the inverter is turned on for the first time you will be asked to select the “Country” of installation. This selection allows the inverter to automatically configure its parameters to ensure that compliance with local standards; the default language corresponding to the selected “Country” will also be set.



After the grid standard was set you have 24 hours to make any changes to the grid standard value; 24 hours later the “Country Select.” functionality will be blocked, and any subsequent changes can only be made using a password provided on request by ABB.

- After you have set the “Country” value, the message “Inizializing...Please Wait” is displayed. Depending on the input voltage value, the inverter will show various messages on the display and change the behaviour of the three LED ④.

| Input Voltage | Display Message | LED Status | Description |
|----------------------|-----------------|---|--|
| $V_{in} < V_{start}$ | Waiting Sun | Green = Blinking Yellow = OFF Red = OFF | The input voltage is not sufficient to permit connection to the grid. |
| $V_{in} > V_{start}$ | Missing Grid | Green = Blinking Yellow = ON Red = OFF | There is sufficient input voltage to permit connection to the grid: the inverter waits until there is grid voltage to carry out the parallel connection. |



The inverter is powered **ONLY** by the voltage coming from the photovoltaic generator: presence of grid voltage alone **IS NOT SUFFICIENT** to permit the inverter to start up.

- With the inverter in “Missing Grid” status, close the AC switch downstream the inverter so as to supply the grid voltage to the inverter: the inverter performs the grid voltage check, measures the photovoltaic generator insulation resistance against earth and carries out other self-diagnosis checks. During the checks before the parallel with the grid, the green LED keeps flashing, the others are off.

- During the grid voltage check and measurement of the insulation resistance, the values for the grid voltage and frequency and the insulation resistance measured by the inverter are shown on the display. The inverter completes parallel connection with the grid SOLELY if the grid parameters meet the ranges provided for by the regulations in force and if the insulation resistance is greater than 1Mohm.
- If the preliminary checks for parallel connection to the grid are successful, the inverter connects to the grid and begins to export power to the grid. At this stage, the display shows the inverter's parameters in cycles. The green LED stays lit whereas the others are off.

The "Country" value (grid standard) that can be selected are listed in the following table:

| Displayed name | Display language | Displayed name | Display language |
|----------------|------------------|----------------|------------------|
| SINGAPORE | English | CZECH | Cestina |
| THAIL. PEA | English | TAIWAN | English |
| VDE0126 3W | English | KOREA | English |
| THAIL. MEA | English | HUNGARY | English |
| FRANCE 14 | French | CORSICA | French |
| EN50438 | English | PORTUGAL | English |
| CEI 016 | Italian | GREECE | English |
| TURKEY HV | English | NETHERL. | Dutch |
| SLOVENIA | English | FRANCE 13 | French |
| ROMANIA | English | BDEW | German |
| TURKEY LV | English | ISRAEL | English |
| BRAZIL | English | AS 4777 | English |
| C1011 110 | French | IRELAND | English |
| C1011 100 | French | UK G59 | English |
| RD 1565 | Spanish | UK G83 | English |
| S. AFRICA | English | RD 1699 | Spanish |
| CEI 021 EX. | Italian | ENEL | English |
| VDE 4105 | German | VDE 0126 | English |

The list of grid standards given in the table was valid at the time of issue of the manual. It will be continually updated as new country standards with which the inverter is compatible are introduced



Display access and settings

Once the inverter has been commissioned, it is possible/necessary to configure the inverter by accessing the Settings Menu directly from the display. The following are the main adjustable parameters (see the section on “**Menu descriptions**”)

- **RS485 address:** setting required in the case of system monitoring via the RS485 line
- **Vstart:** setting required if requested by the configurator during the system sizing procedure (“Vstart” parameter)
- **MPPT scan:** allows maximum power point tracking with settable sensitivity and time interval (“MPPT” parameter).
 - **Reactive power feed-in setting (where present):** setting necessary for managing the different ways of feeding reactive power into the grid (“Reactive Power” parameter)
 - **Active power limitation setting (where present):** setting necessary to set a limit on the active power supplied by the inverter (“Power reduction” parameter)



LED behaviour

- = LED On
 ⊗ = LED flashing
 ⊗ = LED Off
 ⊗ = Any one of the conditions described above

The following table shows all the possible activation combinations of LEDs on the LED panel according to the operating status of the inverter.

| LED status | Operating state |
|---------------------------------|--|
| green: ⊗ yellow: ⊗ red: ⊗ | Firmware programming The inverter firmware is being programmed |
| green: ⊗ yellow: ⊗ red: ⊗ | Night mode (inverter automatically switches off) The inverter is in night time switch-off mode (input voltage less than 70% of the set start-up voltage). |
| green: ⊗ yellow: ⊗ red: ⊗ | Inverter initialisation This is a transitional state during verification of the operating conditions. During this stage the inverter checks that the conditions for connecting to the grid are met. |
| green: ● yellow: ⊗ red: ⊗ | The inverter is connected and is feeding power into the grid Normal operation During this stage, the inverter automatically tracks and analyses the photovoltaic generator's maximum power point (MPP). |
| green: ⊗ yellow: ● red: ⊗ | Disconnection from the grid Indicates no grid voltage. This condition does not allow the inverter to connect to the grid (the inverter display shows the message "Missing Grid"). |
| green: ⊗ yellow: ● red: ⊗ | Indication of Warning (W message codes) or Error (E message codes) states Indicates that the inverter control system has detected a warning (W) or error (E). The display shows a message indicating the type of problem found (see Alarm messages). |
| | <ul style="list-style-type: none"> • Ventilation anomaly Indicates an anomaly in the operation of the internal ventilation system that could limit output power at high ambient temperatures. |
| | <ul style="list-style-type: none"> • Failed association of internal inverter components (after replacement) Indicates that the installed wiring box (only in the event of a replacement) was already associated with another inverter and cannot be associated with the new inverter |
| green: ⊗ yellow: ⊗ red: ⊗ | <ul style="list-style-type: none"> • Overvoltage surge arresters triggered (where fitted) Indicates that any class II overvoltage surge arresters installed on the AC or DC side have been triggered |
| | <ul style="list-style-type: none"> • String protection fuses triggered (where fitted) Indicates that one or more input string protection fuses that may be installed have been triggered |
| | <ul style="list-style-type: none"> • Autotest (for Italian grid standards only) The inverter is performing a self-test |
| green: ⊗ yellow: ⊗ red: ● | Anomaly in the insulation system of the photovoltaic generator Indicates that a leakage to ground from the FV generator has been detected, causing the inverter to disconnect from the grid. |



Specifications on the operation of the LEDs

In correspondence to each status of the inverter indicated by the constant or intermittent lighting of the specific LED, the display ⑤ also shows a message identifying the operation which is being carried out or the defect/anomaly recorded (see specific chapter).



In the case of malfunction it is extremely dangerous to intervene personally to try and eliminate the defect. The instructions below must be followed scrupulously; if you do not have the necessary experience and training to intervene safely, please contact a specialist.

LED insulation fault

Interventions after warning of insulation fault

When the red LED comes on, first try to reset the warning by pressing the multi-function ESC button on the keyboard ⑥.

If the inverter reconnect normally to the network, the fault was due to temporary phenomena.

You are advised to have the plant inspected by the installer or a specialist if this malfunction occur repeatedly.

If the inverter doesn't reconnect to the grid, isolate it on both the AC and DC sides (by using the disconnect switches), then contact the installer or authorised centre to repair the fault in the photovoltaic generator.





Description of the menus

The inverters are equipped with a Display ⑤, consisting of 2 lines of 16 characters each, which can be used to:

- Display the operating state of the inverter and the statistical data
- Display the service messages for the operator
- Display the alarm and fault messages for the operator
- Changing the settings of the inverter

General information

While the inverter is operating, the display shows various items of information on the main parameters measured, the operating conditions and the inverter's operating status.

The display cycles through the information when the icon  is shown on the display; if the icon shown on the display is a padlock  it means that the display of information is locked and the UP and DOWN buttons can be used to scroll through the screens of information instead. You can switch between the two display modes by pressing the ENTER button.



The sequence of screens displayed is shown below, with a description of the parameters monitored.

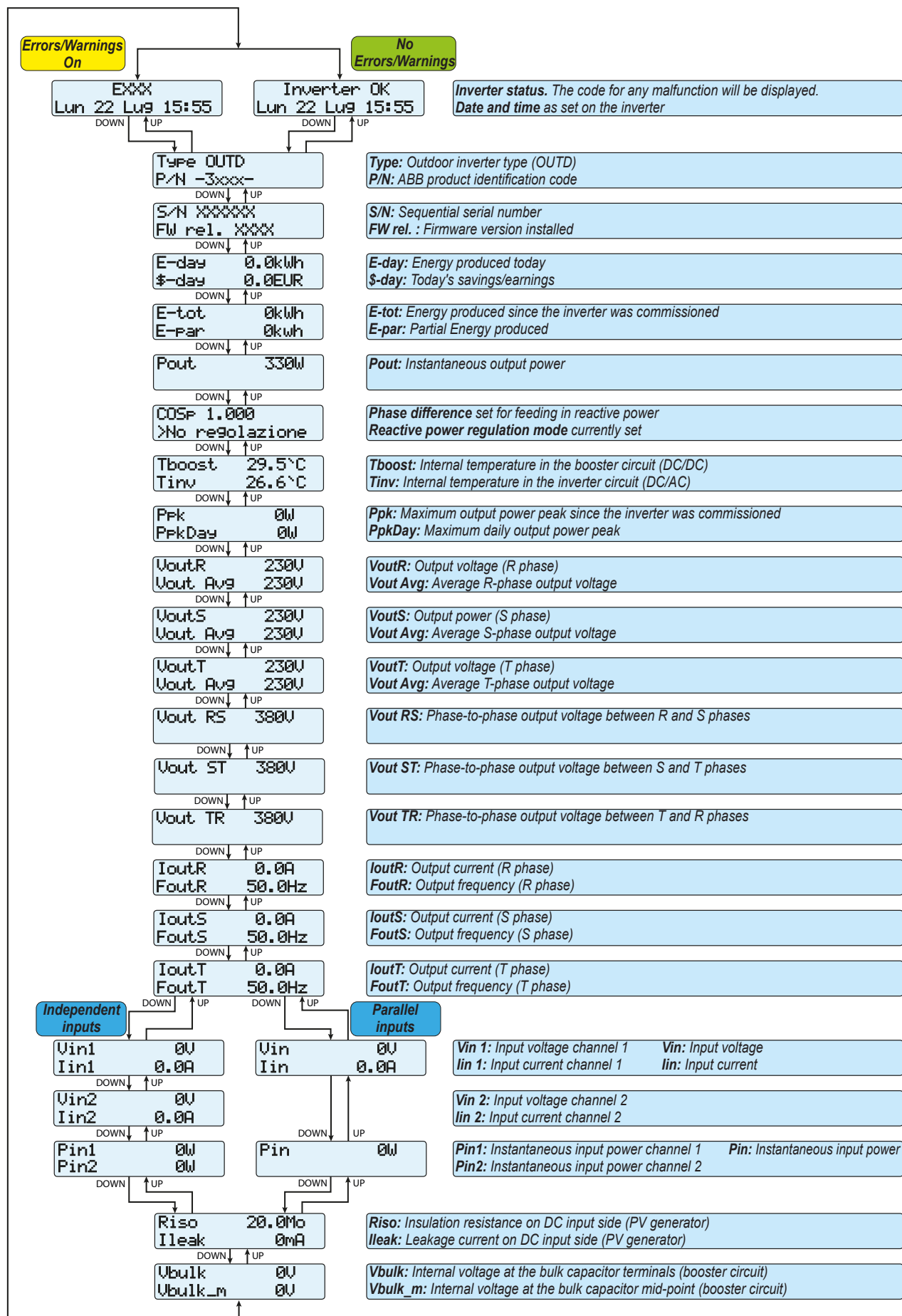

Statistics Menu

Selecting STATISTICS from the three main sub-menus gives access to:

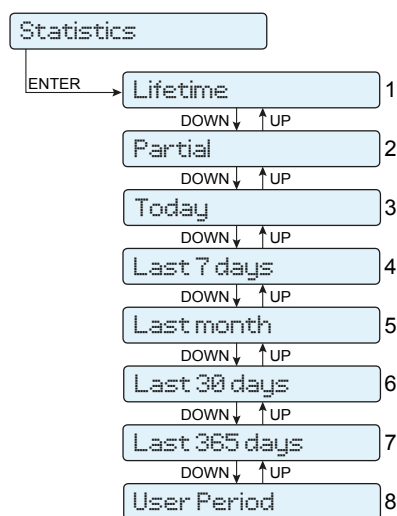

1. Lifetime

This section of the menu displays the Lifetime statistics:

- **Time:** Total operating time
- **E-tot:** Total energy produced
- **Val. :** Total production value, calculated using the currency and conversion coefficient set in the relevant section of the SETTINGS menu
- **CO₂:** Amount of CO₂ saved compared to fossil fuels

2. Partial

This section of the menu displays the Partial statistics:

- **Time:** Partial operating time
- **E-par:** Partial energy produced
- **P-Peak:** Peak power value
- **Val. :** Partial production value, calculated using the currency and conversion coefficient set in the relevant section of the SETTINGS menu
- **CO₂:** Partial amount of CO₂ saved



To reset all the counters of this sub-menu, press the ENTER button for more than 3 seconds. At the end of this time, you will hear a sound repeated 3 times.

3. Today

This section of the menu displays today's statistics:

- **E-day:** Energy produced today
- **P-Peak:** Today's peak power value
- **Val. :** Value of today's production, calculated using the currency and conversion coefficient set in the relevant section of the SETTINGS menu
- **CO₂:** Amount of CO₂ saved today

4. Last 7 days

This section of the menu displays the statistics for the last 7 days:

- **E-7d:** Energy produced over the last 7 days
- **Val. :** Value of production over the last 7 days, calculated using the currency and conversion coefficient set in the relevant section of the SETTINGS menu
- **CO₂:** Amount of CO₂ saved over the last 7 days

5. Last month

This section of the menu displays the statistics for the last month:

- **E-mon:** Energy produced during the current month
- **Val. :** Value of the last month's production, calculated using the currency and conversion coefficient set in the relevant section of the SETTINGS menu
- **CO₂:** Amount of CO₂ saved during the current month

6. Last 30 days

This section of the menu displays the statistics for the last 30 days:

- **E-30d:** Energy produced over the last 30 days
- **Val. :** Value of production over the last 30 days, calculated using the currency and conversion coefficient set in the relevant section of the SETTINGS menu
- **CO₂:** Amount of CO₂ saved over the last 30 days

7. Last 365 days

This section of the menu displays the statistics for the last 365 days:

- **E-365d:** Energy produced over the last 365 days
- **Val. :** Value of production over the last 365 days, calculated using the currency and conversion coefficient set in the relevant section of the SETTINGS menu
- **CO₂:** Amount of CO₂ saved over the last 365 days

8. User period

This section of the menu displays the statistics for a period chosen by the user:

Once the start and end dates for the period have been set, the following data are available:

- **E:** Energy produced over the selected period
- **Val. :** Value of production over the selected period, calculated using the currency and conversion coefficient set in the relevant section of the SETTINGS menu
- **CO₂:** Amount of CO₂ saved over the selected period



Settings Menu

Selecting SETTINGS from the three main sub-menus brings up the first screen, asking for the password.

The default password is "0000".

This can be changed by using the display buttons, following the same procedure as always:

- ENTER scrolls through the digits (from left to right)
- ESC returns to the previous digit (from right to left)
- Press ESC several times to return to the previous menu
- DOWN scrolls down the numerical scale (from 9 to 0)
- UP scrolls up the numerical scale (from 0 to 9)

After entering the password, press ENTER to access the information in this section:

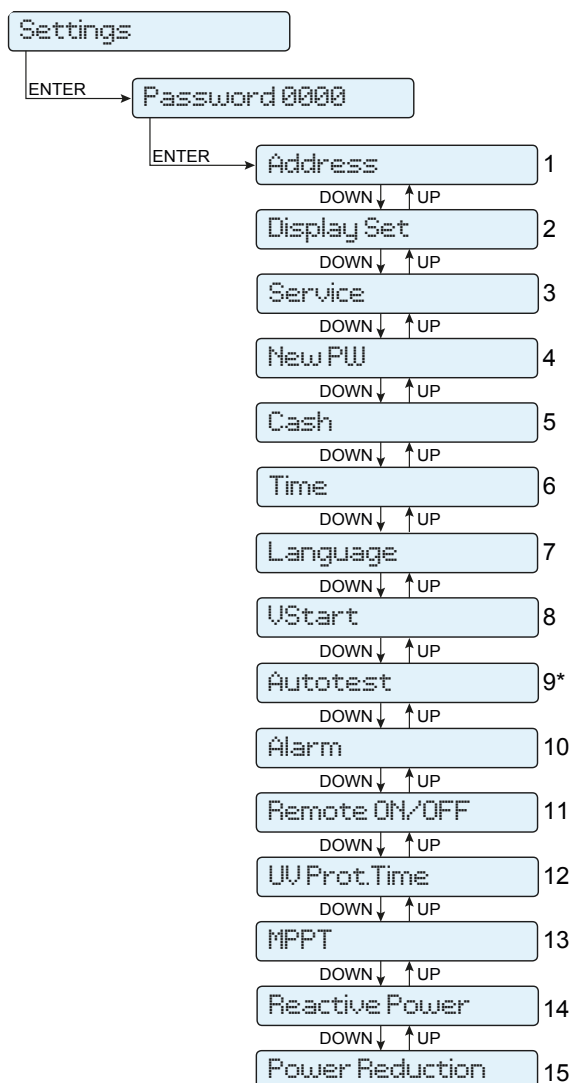

(*) Available for the Italian country standard only. Refer to the section on this topic in the manual.



1. Address

This section of the menu allows you to set the serial port addresses of the individual inverters connected to the RS485 line.

The addresses that can be assigned are 2 to 63. The UP and DOWN buttons scroll through the numerical scale.

'AUTO' selection cannot be used at present.

2. Display Set

This section of the menu allows you to set the display properties:

- **Light:** sets the lighting mode and adjusts the display backlight

- **MODE:**

ON: Light always on

OFF: Light always off

Auto: Automatic backlight control. The light is switched on whenever a button is pressed and stays on for 30 sec, after which it gradually dims out.

- **Intensity:** adjusts display brightness (scale from 1 to 9)

- **Contrast:** adjusts display contrast (scale from 1 to 9)

- **Buzzer:** sets button sound

ON: button sound is on

OFF: button sound is off

3. Service

This section of the menu is reserved for installers.

A special access password is required, which may be obtained from the website <https://registration.ABBsolarinverters.com>.

Before connecting to the site, make sure you have all the information required to calculate your password:

Inverter Model, Serial Number, week of manufacture.

When you have a password you can set the parameters in the menu.

Changing the above-mentioned parameters may prevent disconnection from the grid if the new values exceed those given in the standards of the country of installation. If these parameters are changed to values outside the standard range, an interface protection must be installed external to the inverter in accordance with the requirements of the country of installation.



The table below shows the parameters that can be changed and the range of values that may be set for each:

| Parameter | Description | Setting range |
|--------------------|---|---|
| Set U>> | Grid over-voltage (OV) threshold (extended range) | Unom ... Unom x 1.3 |
| Set U<< | Grid under-voltage (UV) threshold (extended range) | 10V ... Unom |
| Set F>> | Grid over-frequency (OF) threshold (extended range) | Fnom ... Fnom + 5Hz |
| Set F<< | Grid under-frequency (UF) threshold (extended range) | Fnom - 5Hz ... Fnom |
| Set U> | Grid over-voltage (OV) threshold (restricted range) | Unom ... Unom x 1.3 |
| Set U> (10Min) | Grid over-voltage (OV) threshold (average grid voltage value) | Unom ... Unom x 1.3 |
| Set U< | Grid under-voltage (UV) threshold (restricted range) | 10V ... Unom |
| Set F> | Grid over-frequency (OF) threshold (restricted range) | Fnom ... Fnom + 5Hz |
| Set F< | Grid under-frequency (UF) threshold (restricted range) | Fnom - 5Hz ... Fnom |
| Set Uconn> | Max. permissible voltage during checks prior to grid connection | Unom ... Unom x 1.3 |
| Set Uconn< | Min. permissible voltage during checks prior to grid connection | 10V ... Unom |
| Set Fconn> | Max. permissible frequency during checks prior to grid connection | Fnom ... Fnom + 5Hz |
| Set Fconn< | Min. permissible frequency during checks prior to grid connection | Fnom - 5Hz ... Fnom |
| Set Time U>> | Over-voltage U>> protection tripping time | 0 ... 327670mS |
| Set Time U<< | Under-voltage U<< protection tripping time | |
| Set Time F>> | Over-frequency F>> protection tripping time | |
| Set Time F<< | Under-frequency F<< protection tripping time | |
| Set Time U> | Over-voltage U> protection tripping time | |
| Set Time U< | Under-voltage U< protection tripping time | |
| Set Time F> | Over-frequency F> protection tripping time | |
| Set Time F< | Under-frequency F< protection tripping time | |
| Set time conn 1 | Grid check time prior to connection | 0 ... 65535mS |
| Set time conn 2 | Grid check time prior to connection after a grid fault | |
| Disable U>> | Disables the U>> protection threshold | Enabled/Disabled |
| Disable U<< | Disables the U<< protection threshold | |
| Disable F>> | Disables the F>> protection threshold | |
| Disable F<< | Disables the F<< protection threshold | |
| Disable U> | Disables the U> protection threshold | |
| Disable U> (10Min) | Disables the U> (10Min) protection threshold | |
| Disable U< | Disables the U< protection threshold | |
| Disable F> | Disables the F> protection threshold | |
| Disable F< | Disables the F< protection threshold | |
| U> (10Min) Der. | Enables power derating mode due to high average grid voltage readings | |
| Slow Ramp | Enables gradual ramping up of power after the grid connection. | |
| OF Derating | Selects the power derating mode in the event of grid over-frequency. | 0 Derating disabled 1 BDEW derating 2 VDE-AR-N derating 3 CEI derating |
| OF Der. Rest. T | Time period after OF derating in which the inverter checks that the frequency is back within the operating ranges (parameters Fconn< and Fconn>) required by the grid standard before ramping up the output from the derating condition | 1 ... 1000S |
| Amorph. Enable | Enables Amorphous Mode in the event that the negative input pole is grounded by installing the Negative Grounding Kit (not available) | Enabled/Disabled |
| Reset Country S. | Unlocks the grid standard selection (resets the 24 hours available for changing the grid standard) | Reset |



4. New PW

This section of the menu allows you to change the settings menu password (default 0000).

We advise you to memorize the new password with great care.

If the Password is lost you will not have access to the inverter, since there is no Reset function for security reasons

5. Cash

This section of the menu allows you to set the name of the currency and the value of 1 kWh of energy produced. Setting these parameters correctly allows the actual earnings/savings achieved by the system to be displayed.

- **Name:** sets the desired currency (default is EUR)
- **Val/KWh:** indicates the cost/incentive for 1 kWh in the chosen currency (default is 0.50).

6. Time

Allows you to set the current date and time (not counting summer time)

7. Language

Allows you to set the language you prefer for the menus

8. Vstart

This section of the menu allows you to set the Vstart voltage (for the two channels separately if they are configured independently) to suit the system requirements.

We advise changing the activation voltage only if really necessary and to set it to the correct value: the photovoltaic generator sizing tool available on the ABB website will indicate whether Vstart needs changing and what value to set it at.

9. Autotest

This section of the menu is available only for the Italian country standard. Refer to the section on this topic in the manual.



10. Alarm

This section of the menu allows you to set the activation status of a relay (available either as contact normally open – N.O. – or as contact normally closed – N.C.).

This contact can be used, for example, to: activate a siren or a visual alarm, control the disconnect device of an external transformer, or control an external device.

The relay can be set to switch in 4 different modes:

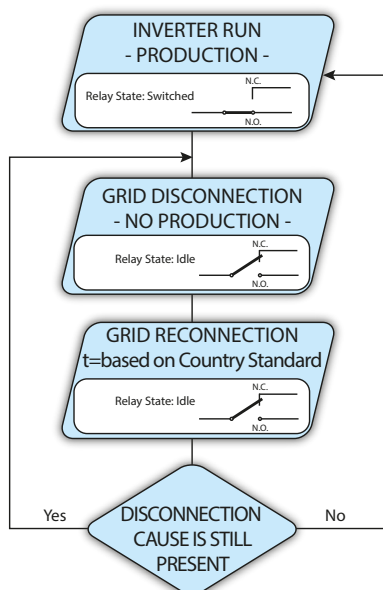

• **Production (display text “PRODUCTION”)**

The relay is activated (state: switched) whenever the inverter connects to the grid; as soon as the inverter is disconnected from the network (for whatever reason that caused disconnection), the relay is in its resting position

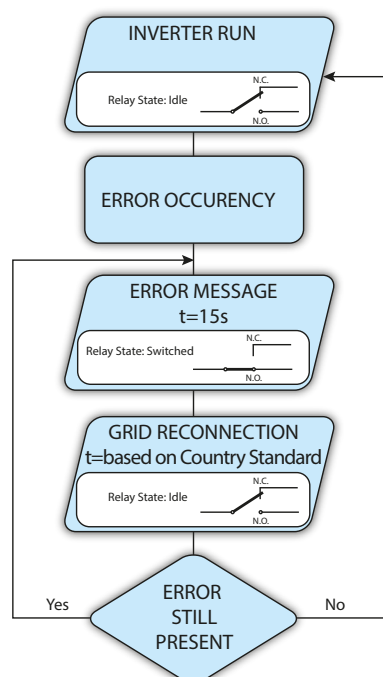

• **Alarm with reset at the end of the alarm signalling process (display text “ALARM”):**

The relay is activated (state: switched) whenever an error is present (code Exxx) on the inverter; this does not apply to warnings (Warning – code Wxxx). The alarm returns to its resting position when the alarm signal ends, i.e. before the inverter checks the grid parameters after the alarm state. This is because grid control state is not an alarm state but a state of normal operation.

Alarms for which the relay is activated

| | | | | | |
|------|------|------|------|------|------|
| E001 | E002 | E003 | E004 | E005 | E006 |
| E007 | E010 | E011 | E012 | E013 | E014 |
| E015 | E016 | E017 | E018 | E019 | E020 |
| E021 | E022 | E023 | E026 | E029 | E030 |
| E031 | E032 | E033 | E034 | E046 | E049 |
| E050 | E051 | E053 | E054 | E055 | E056 |
| E057 | E058 | W003 | | | |

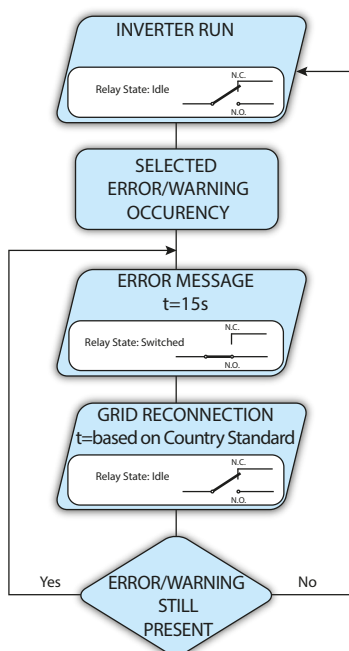

• **Configurable alarm with reset at the end of the alarm signalling process (display text “Alarm Conf.”)**

The relay is activated (state: switched) whenever an error is present (code Exxx) or a warning (code Wxxx) from those selected from the list in the dedicated submenu. The contact returns to its resting position when the alarm signal ends, i.e. before the inverter checks the grid after the alarm state. This is because grid control state is not an alarm state but a state of normal operation.

Selectable alarms for which the relay is activated

| | | | | | |
|------|------|------|------|--------------|------|
| E001 | E002 | E003 | E004 | E005 | E006 |
| E007 | E010 | E011 | E013 | E014 | E015 |
| E017 | E018 | E019 | E020 | E021 | E022 |
| E023 | E026 | E027 | E028 | E029 | E030 |
| E031 | E032 | E033 | E034 | E046 | E050 |
| E051 | E053 | E054 | E055 | E056 | E057 |
| E058 | W001 | W002 | W003 | W008 | W009 |
| W011 | W017 | W018 | W019 | W021 | W022 |
| W023 | W024 | W025 | W026 | Ground fault | |

For both configurable relay operating modes “ALARM” and “ALA”. CONF.” the following considerations apply:

If the alarm condition is persistent, the alarm contact cyclically switches from its resting state to its activated state.

In the presence of W003 signalling (Grid Fail – Network parameters out of tolerance), the alarm contact switches to then reset itself at the end of the alarm signal. This means that during the absence of grid voltage (display message “Vac Absent”) the alarm contact remains in its resting position.

In the presence of W002 signalling (UV Input – input voltage below the limit of operation), the alarm contact switches to then reset itself at the end of the alarm signal. This means that during the reduced input voltage (display message “Waiting sun”) the alarm contact remains in its resting position.

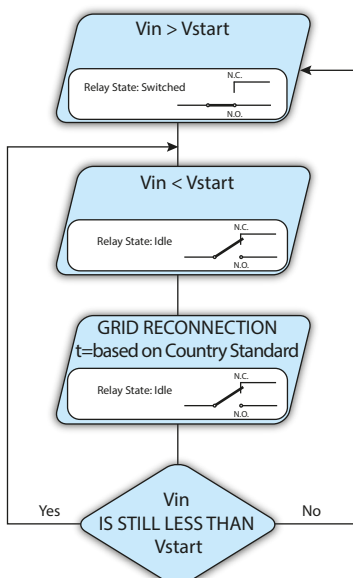

• **Crepuscular (display text “CREPUSCULAR”)**

The relay is activated (state: switched) as soon as the inverter input voltage exceeds the activation voltage set.

The relay is in its rest position when the input voltage drops below 70% of the activation voltage set.

This mode is useful for disconnecting any output transformers that could have unnecessary consumption during the night.

11. Remote ON/OFF

This section of the menu allows you to enable/disable the connection/disconnection of the inverter to/from the grid through the relevant control signal (**R+**).

- **Disable:** the connection/disconnection of the inverter to/from the grid is dictated by the input (voltage from the photovoltaic generator) and output (grid voltage) parameters of the inverter.
- **Enable:** the connection/disconnection of the inverter to/from the grid is dictated by the state of the "**R+**" signal compared to the **R-** signal, as well as by the input (voltage from the photovoltaic generator) and output (grid voltage) parameters of the inverter.

12. UV Prot. Time

This section of the menu allows you to set the time for which the inverter stays connected to the grid after the input voltage has dropped below the Under Voltage limit (set at 70% of V_{start}). ABB sets the time at 60 sec. The user can set it at any time from 1 to 3600 sec.

Example: with UV Prot. Time set at 60 seconds, if voltage V_{in} drops below 70% of V_{start} at 9:00, the inverter stays connected to the grid (taking power from it) until 9:01.

13. MPPT

This section of the menu allows you to set the parameters of the maximum power point tracking (MPPT) function. This function is useful when there are areas of shade on the PV generator, which may create several points of maximum power on the operating curve.

- **MPPT Amplitude:** by setting this parameter you can choose the amplitude of the DC perturbation introduced to establish the optimal operating point. There are 3 settings to choose from (LOW, MEDIUM, HIGH). The default setting is MEDIUM.

- **Multi-max scan:** by setting this parameter, you can enable/disable the scan, decide the frequency with which the scan is carried out and override it manually.

- **Enable/Disable:** Enables/disables the scan for identifying the maximum power point of the system.

- **Scan Interval:** this allows you to set the time between scans. It should be borne in mind that the shorter the scan interval the greater the loss of production, due to the fact that energy is transferred to the grid during the scan but not at the maximum power point. Each scan takes roughly 2 seconds.



14. Reactive power

This section of the menu may be used to manage the supply of reactive power into the grid. There are 5 possible types of management:

- **No regulation:** no regulation of reactive power. To enable this mode, select **Enable** and then **OK** (using the UP / DOWN arrows)
- **Cos-phi fixed:** Sets the power rating to a fixed value. To enable this mode, select **Enable** and then **OK** (using the UP / DOWN arrows) When enabled, **Set value** will appear on the display, allowing you to set the value of Cos-Phi (as either Over or Under excited, from 1.000 to 0.800)
- **Q fixed:** Sets the reactive power rating to a fixed value. To enable this mode, select **Enable** and then **OK** (using the UP / DOWN arrows) When enabled, **Set value** will appear on the display, allowing you to set the value of reactive power rating (as either Over or Under excited, from 1.000 to 0.001).
- **Cos-phi = f(P):** Power rating as a function of the active power supplied by the inverter. To enable this mode, select **Enable** and then **OK** (using the UP / DOWN arrows). When it has been enabled, **Load std curve** will appear on the display, allowing you to set the following control curve:

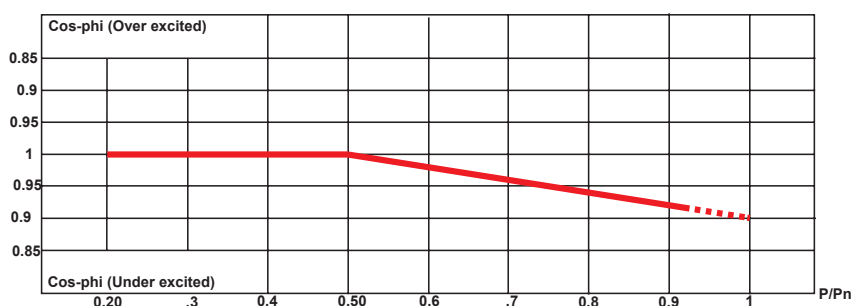

The curve can be edited with the Aurora Manager LITE configuration software

- **Q = f(U):** reactive power as a function of the grid voltage measured by the inverter. To enable this mode, select **Enable** and then **OK** (using the UP / DOWN arrows). When it has been enabled, **Load std curve** will appear on the display, allowing you to set the following control curve(*):

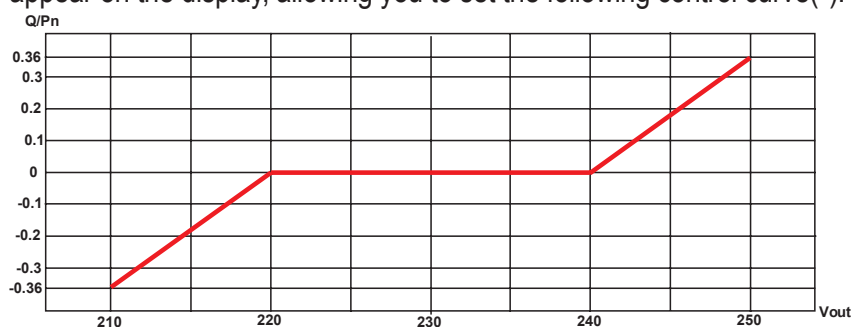

The curve can be edited with the Aurora Manager LITE configuration software

15. Power reduction

This section of the menu allows you to adjust the limit to the active power that the inverter can feed into the grid by setting the percentage of nominal power at which the limit should be triggered.

Setting it to 100% resets the default maximum power, which in some installation country standards may be 110% of nominal power.

Info Menu

Selecting INFO from the three main sub-menus gives access to:

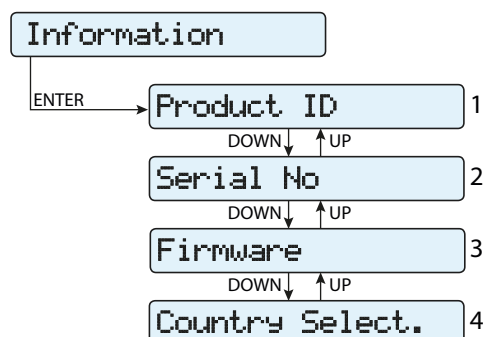

1. Part No.

Displays the model code.

2. Serial No.

Displays the serial number and week and year of manufacture of the equipment .

3. Firmware

Displays the firmware version installed in the equipment.

4. Country Select.

Displays information on the grid standard set with the rotary switches.

- **Actual value:** Displays the grid standard set.

- **New value:** Allows you to select a new grid standard (by using the UP and DOWN buttons), which will only become effective when the equipment has been switched off and on again, or when the selection has been confirmed in the Set new value submenu described below.

The grid standard can only be changed if the time allowed for doing so (24 hours of operation) has not expired.

Set new value: This allows you to confirm/set the new grid standard set in the “New value” section of the previous menu.

- **Residual time:** Displays the time remaining in which it is still possible to set a new grid standard. When the time expires, “Locked” will be displayed, which indicates it is not possible to change the grid standard again.



AUTOTEST procedure in accordance with standard CEI 0-21

The autotest run in accordance with grid standard **CEI-021** may be initiated from the display menu or by using an RS485/USB converter with the dedicated interface software (Aurora Communicator).

The conditions required to perform an Autotest are:

- The grid standard must be set to CEI-021.
- You must not intervene in any way while the test is underway
- You must check that the device has a stable network connection.

Running the tests from the display menu

In the Autotest section of the SETTINGS menu, select the type of test the device is to run from the following:

OV Test – parameters:

U>>R, U>>S, U>>T; U>R, U>S, U>T;

U> (10Min)R, U> (10Min)S, U> (10Min)T

Disconnection from the distribution grid due to “Over-voltage”

UV Test – parameters:

U<<R, U<<S, U<<T: U<R, U<S, U<T

Disconnection from the distribution grid due to “Under-voltage”

OF Test – parameters:

F>> and F>

Disconnection from the distribution grid due to “Over-frequency”

UF Test – parameters:

F<< and F<

Disconnection from the distribution grid due to “Under-frequency”

Go to the SETTINGS > Autotest menu

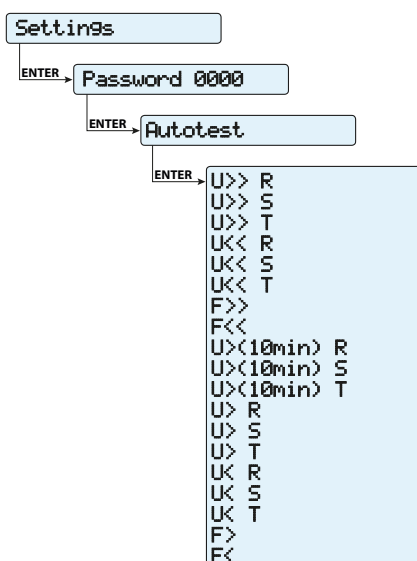

Various signs may be displayed alongside the parameters on which the autotest can be performed. These have the following meanings:

N/A - Test cannot be performed because the relevant parameter is not active

Idle - Test enabled but not yet performed

OK - Test enabled and performed successfully

If one of the protections is disabled (from the Service menu), N/A (not applicable) will appear next to the name of the test.

While one of the tests is being performed, the set limits will be gradually increased/reduced (depending on the type of test) until the threshold at which the inverter is disconnected from the grid is reached. The procedures for running the Autotest comply with the legislation in force.

```
Test in corso
*****
```

The display shows the message “Performing Test” when the test has started.

At the end of the test, when the inverter has disconnected from the grid, the results and values of the test performed will appear on the display. You can move from one screen to another using the UP/DOWN arrow keys.

Details of the data available in each screen are provided below:

Screen 1 of 3

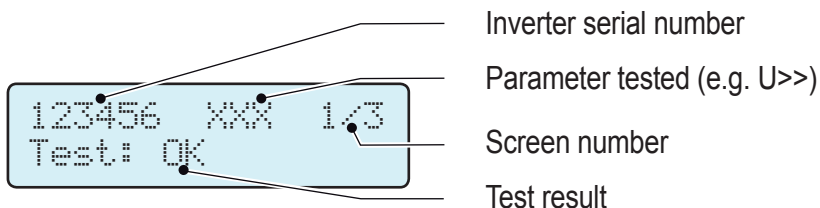

Screen 2 of 3

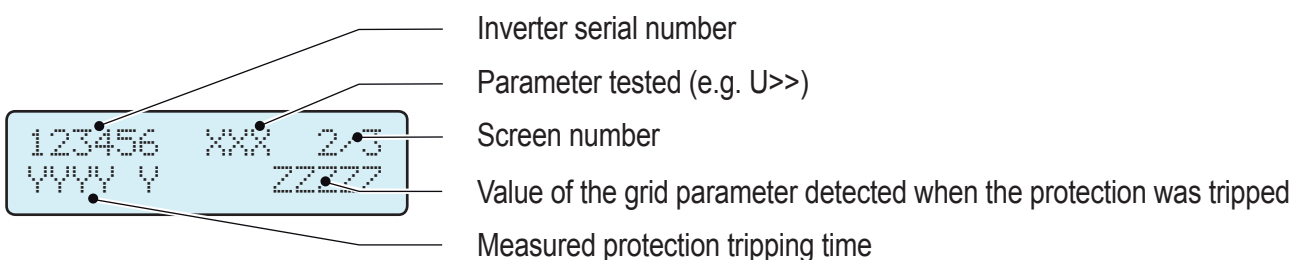

Screen 3 of 3

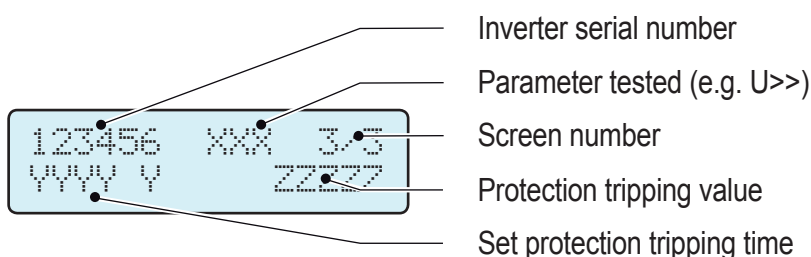

The test results should be considered valid on the basis of the following tolerances, as reported in the applicable legislation:

- $\leq 5\%$ for voltage thresholds
- ± 20 mHz for frequency thresholds
- $\leq 3\% \pm 20$ ms for tripping times

Press ESC to go back to the Autotest menu, from where you may select the next test to be performed

Maintenance

8

General conditions

Routine and periodic maintenance operations must only be carried out by specialized staff with knowledge of how to perform these tasks.



Maintenance operations must be performed with the apparatus disconnected from the grid (power switch open) and the photovoltaic panels obscured or isolated, unless otherwise indicated.



*For cleaning, DO NOT use rags made of filamentary material or corrosive products that may corrode the equipment or generate electrostatic charges.
Avoid temporary repairs. All repairs should be carried out using only genuine spare parts.
The maintenance technician is to promptly report any anomalies.*

DO NOT allow the equipment to be used if problems of any kind are found.



Always use personal protective equipment (PPE) provided by the employer and comply with local safety regulations.

Routine maintenance



Scheduled maintenance operations are not mandatory, but are recommended to preserve the efficiency of the PV plant.



We recommend that maintenance operations be carried out by qualified personnel or by the personnel of ABB (as set forth in a maintenance contract).

The periodicity of the maintenance operations may vary in accordance with local environmental conditions and the installation

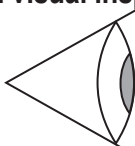
Table: routine maintenance

| | |
|--|---|
| Annual visual inspection  | <ul style="list-style-type: none"> • Check that the inverter is operating correctly, and that no fault alarms are present • Ensure all the labels and safety symbols are visible • Test the integrity of the cables, connectors, and plugs external to the inverter • Check that the environmental conditions have not changed drastically since the installation of the system |
| Annual operations  | <ul style="list-style-type: none"> • Check that cable glands and connection block screws are tight • Check that the wiring box cover is properly closed • If no monitoring system is present, check the history log of alarms and errors using the instructions given in the manual in order to look for recent malfunction warnings |
| Annual cleaning  | <ul style="list-style-type: none"> • Clean the equipment; in particular the bottom grille of the wiring box and the heat sink |

Troubleshooting

Follow the table shown in the following paragraph in order to understand and resolve warning (Wxxx) and error (Exxx) messages displayed by the inverter













The operations carried out on the inverter in order to identify and resolve malfunctions may be carried out only by the organization that carried out the installation or by qualified personnel

Alarm Messages











The equipment is able to indicate errors/warnings on the display only if the input voltage is higher than the V_{dcmin} voltage (POWER LED flashing or on; see operation chapter).

The messages and their codes are indicated on the display.

The following table gives the complete list of errors/warnings relating to string inverters. Some error/warning codes may not be used depending on the inverter model installed.

| - Code on display - Error message - Signal | Name of Alarm and Cause | Solution |
|--|---|---|
| <ul style="list-style-type: none"> - No code - Ground F -  Red LED | <p>Ground fault of photovoltaic generator: The alarm is generated when a leakage current to ground is detected in the DC section of the system.</p> | <ul style="list-style-type: none"> • Measure the insulation resistance using a megohmmeter positioned in the photovoltaic field (positive terminal short-circuited at the negative pole) compared to ground. The measurement is strongly influenced by the environmental conditions, so must be taken under the same conditions in which the error occurred. - If the value measured is lower than 1 megaohm, a check must be carried out by a technician/installer on the photovoltaic generator to identify and eliminate the problem. - If the value measured is higher than 1 megaohm and the error signal persists, contact customer assistance. |
| <ul style="list-style-type: none"> - No code - NEW COMPONENT REFUSED! -  Yellow LED lamp. | <p>Lack of linkage of the new component: The components inside the inverter (e.g. display, fuse board, communication and control board, etc.) are not inter-linked. This occurs following the replacement of one of the components inside the inverter.</p> | <ul style="list-style-type: none"> • Link the components inside the inverter by accessing the "Settings > Service > Accept boards" (refer to the procedure given in this manual). - If the signal persists also following the linking of the components, contact customer assistance. |
| <ul style="list-style-type: none"> - No code - SET COUNTRY or NO NATION -  No LED | <p>SET COUNTRY or NO NATION: Indicates that in the installation phase the grid standard was not set on the inverter.</p> | <ul style="list-style-type: none"> • Set the grid standard of the country of installation following the instructions given in this manual for the inverter. - If the signal persists also following setting the grid standard, contact customer assistance. |
| <ul style="list-style-type: none"> - No code - Vac absent -  Yellow LED | <p>Vac absent: The inverter displays the "Vac absent" message when it does not record output voltage (AC side).</p> | <ul style="list-style-type: none"> • Check the grid voltage on the inverter's AC terminal block. - Should it be absent, check any protection work on the line and the presence of grid voltage on the supply point. |
| <ul style="list-style-type: none"> - No code - Mem. broken -  Yellow LED | <p>Memory broken: The inverter displays the "Memory broken" message when it records a communication problem with the memory board on which the inverter saves the daily value of energy produced.</p> | <ul style="list-style-type: none"> • Remove the memory board and check the welding of all the connector's terminals. Subsequently reinsert the memory board and check that it is correctly inserted into the dedicated slot - If the signal persists also following the above checks, contact customer assistance. |
| <ul style="list-style-type: none"> - No code - Awaiting sun -  Green LED lamp. | <p>Awaiting sun: The inverter displays the "awaiting sun" message when, following a W001 and/or W002 notice, the voltage from the photovoltaic generator is less than the activation voltage (Vstart).</p> | <ul style="list-style-type: none"> • Check the input voltage on the inverter. - If it does not exceed Vstart, check for the presence of sufficient irradiation and the correct composition of the system. - If it exceeds Vstart, contact customer assistance |
| <ul style="list-style-type: none"> - W001 - Sun Low -  Yellow LED | <p>Insufficient irradiation (Low input voltage on switching on the inverter): Incorrect configuration of the PV generator or an "on the limit" configuration for the inverter's minimum input voltage.</p> | <ul style="list-style-type: none"> • Check the input voltage on the inverter. - If it does not exceed Vstart, check for the presence of sufficient irradiation and the correct composition of the system. - If it exceeds Vstart, contact customer assistance |
| <ul style="list-style-type: none"> - W002 - Input UV -  Yellow LED | <p>Insufficient irradiation (Low input voltage on switching off): Incorrect configuration of the photovoltaic generator or an "on the limit" configuration for the inverter's minimum input voltage.</p> | <ul style="list-style-type: none"> • Check the input voltage on the inverter. - If it does not exceed Vstart, check for the presence of sufficient irradiation and the correct composition of the system. - If it exceeds Vstart, contact customer assistance |
| <ul style="list-style-type: none"> - W003 - Grid Fail -  Yellow LED | <p>Parameters of grid voltage outside range: This error signal occurs when during the inverter's normal operation the grid parameters exceed the limits set by the operator: - Grid voltage absent (after the signal the inverter goes to "Vac Absent") - Unstable grid voltage (down or up) Unstable grid frequency</p> | <ul style="list-style-type: none"> • Check the grid voltage on the inverter. - Should it be absent, check for absence of grid voltage on the supply point. - If, on the other hand, the voltage tends to rise (when the inverter is connected) there is high line or grid impedance. • Check the grid voltage also on the supply. - If it is high, it means that there is high grid impedance. In this case, ask the operator to adjust the grid voltage. If the operator authorises a change to the inverter's parameters, agree the new limits with customer assistance - If the voltage at the point of supply is much lower than that measured on the inverter, it is necessary to adjust the line (inverter-contactor). - If the voltage and the grid frequency come back within the limits (also when the inverter is connected to the grid) contact customer assistance |
| <ul style="list-style-type: none"> - W009 - Empty Table -  Yellow LED | <p>Characterisation board for the wind generator not compiled (only WIND models)</p> | <p>(only WIND models)</p> |



| - Code on display - Error message - Signal | Name of Alarm and Cause | Solution |
|---|---|--|
| - W010 * - Fan broken! -  Yellow LED lamp. *not visualised on display | Fan broken: This error occurs when there is a malfunction in the fan/fans inside the inverter. | <ul style="list-style-type: none"> • Error inside the inverter and cannot be checked externally. - If the alarm repeats persistently, contact customer assistance. |
| - W011 - Bulk UV -  Yellow LED | Bulk Under-voltage: The alarm (which is a warning and not an error) is generated when the voltage at the heads of the bulk capacitors does not reach the threshold for the operation of the inverter (internal unchangeable threshold). | <ul style="list-style-type: none"> • Raise the value of the activation voltage (Vstart) so as to have sufficient power from the PV generator at the time of the inverter's grid connection. • Check the input voltage on the inverter. - If it does not exceed Vstart, check for the presence of sufficient irradiation and the correct composition of the system. - If it exceeds Vstart, contact customer assistance |
| - W012 * - Batt. Flat -  Yellow LED *not visualised on display | Battery flat: The inverter displays the "Battery flat" message when it records a voltage for the buffer battery which is too low. | <ul style="list-style-type: none"> • Check that the date/time are set correctly and, if they are not, set them. Subsequently arrange to completely switch off the inverter (on both AC and DC) and wait a few minutes. Finally, restart the inverter and check whether the date/time are now correctly set or whether they have reset to 01/01/2000. In this case replace the battery with the inverter completely switched off (section AC and DC side) being careful to maintain the polarity |
| - W013 * - Clock broken -  Yellow LED *not visualised on display | Clock broken: The alarm occurs when there is a difference of over 1 minute in the time displayed compared to the internal time of the microprocessors and indicates a malfunction of the clock circuit. | <ul style="list-style-type: none"> • Error inside the inverter and cannot be checked externally. - If the alarm repeats persistently, contact customer assistance. |
| - W017* - String Err. -  Yellow LED lamp. * (only for models with monitored string fuses) | Error recorded in measuring string currents: Damaged string protection fuse(s) | <ul style="list-style-type: none"> • Check with a multimeter the state of the fuses (positioned on the fuse boards). - If one or more fuses is open, arrange to replace them and check that the input current on the string(s) does not exceed the rating of the fuses (should parallel strings have been made outside the inverter). - If there are no damaged string fuses and the inverter continues to show the alarm message check whether the settings to be made through the Aurora Manager software are correct (presence or absence of one or more input strings). |
| - W018 * - SPD DC Err -  Yellow LED lamp. * (only for models with monitored SPD) | Intervention of overvoltage surge arresters on DC side: Damaged overvoltage surge arresters positioned on DC side | <ul style="list-style-type: none"> • Observe the inspection window on each surge arrester (DC side). If it is red, the surge arrester is damaged and the cartridge must be replaced. - If the alarm status persists, even if all the surge arresters have a green inspection window, contact customer assistance. |
| - W019 * - SPD AC Err -  Yellow LED lamp. * (only for models with monitored SPD) | Intervention of overvoltage surge arresters on AC side: Damaged overvoltage surge arresters positioned on AC side | <ul style="list-style-type: none"> • Observe the inspection window on each surge arrester (AC side). If it is red, the surge arrester is damaged and the cartridge must be replaced. - If the alarm status persists, even if all the surge arresters have a green inspection window, contact customer assistance. |
| - W022 * - Reactive power mode changed -  No LED *not visualised on display | Variation in means of managing reactive power: Variation in the means of managing reactive power; this change can be made through the display or advanced configuration software. | The variation in the means of managing reactive power is done directly by the customer/installer and is not an error. The information is only saved on the historic record of the events memorised by the inverter |
| - W023 * - date/time changed -  No LED *not visualised on display | Variation in the inverter's date and time: Variation of the inverter's date and time; this change can be made through the display or advanced configuration software. | The variation in the inverter's date and time is done directly by the customer/installer and is not an error. The information is only saved on the historic record of the events memorised by the inverter |
| - W024 * - Energy data reset -  No LED *not visualised on display | Zeroing of the statistical energy data memorised in the EEPROM: Reset of the energy data saved in the inverter; this operation can be handled through the display or advanced configuration software. | The zeroing of the partial energy values memorised by the inverter is done directly by the customer/installer and is not an error. The information is only saved on the historic record of the events memorised by the inverter <ul style="list-style-type: none"> • The notice may also occur on substitution of the Memory Card where the statistical production data is saved |



| - Code on display - Error message - Signal | Name of Alarm and Cause | Solution |
|--|--|---|
| - E001 - Input OC - ● Yellow LED | Input over-current (photovoltaic generator): The alarm occurs when the inverter's input current exceeds the inverter's threshold for maximum input current. | <ul style="list-style-type: none"> • Check whether the composition of the PV generator enables input current which exceeds the maximum threshold allowed by the inverter and that the configuration of the inputs (independent or in parallel) is carried out correctly. - If both checks are positive, contact customer assistance. |
| - E002 - Input OV - ● Yellow LED | Input over-voltage (photovoltaic generator): The alarm is generated when the input voltage (from the PV generator) exceeds the inverter's threshold of maximum input voltage. The alarm occurs before reaching the absolute threshold over which the inverter is damaged. When the inverter's input voltage exceeds the Over Voltage threshold, the inverter will not start up due to the generation of the alarm. | <ul style="list-style-type: none"> • It is necessary to measure the input voltage inside the inverter with a voltmeter. - If it is higher than the maximum voltage of the operating range, the alarm is genuine and it is necessary to check the configuration of the PV generator. If the voltage has also exceeded the maximum input threshold the inverter could be damaged. - If it is lower than the maximum voltage of the operating range, the alarm is caused by an internal malfunction and it is necessary to contact customer assistance. |
| - E003 - No Parameters - ● Yellow LED | DSP initialisation error: The main microcontroller cannot initialise correctly the two DSPs (booster stage and inverter stage). The error is caused by communication problems on the inverter's internal bus. | <ul style="list-style-type: none"> • Error inside the inverter and cannot be checked externally. - If the problem (once the inverter has been switched off and back on) persists, contact customer assistance. |
| - E004 - Bulk OV - ● Yellow LED | "Bulk" over-voltage (DC-DC circuit): Error inside the inverter. The alarm is raised when the voltage at the heads of the bulk capacitors exceeds the Over Voltage threshold (internal unchangeable threshold). | <ul style="list-style-type: none"> • The alarm may be triggered by causes external to the inverter: - An excessive input voltage can be recorded as a condition for bulk over voltage. In this case it is advisable to check the inverter's input voltage and should this value be close to the input OV threshold, review the configuration of the photovoltaic generator. - Excessive grid voltage could cause the bulk voltage to rise in uncontrolled fashion with a consequent protection intervention and hence generation of the alarm. In these cases the alarm is transitory and the inverter automatically restarts - The alarm may be triggered by causes inside the inverter and in this case it is necessary to contact customer assistance. |
| - E005 - Comm.Error - ● Yellow LED | Communication error inside the inverter: The alarm occurs when there are communication problems between the control devices inside the inverter. | <ul style="list-style-type: none"> • Error inside the inverter and cannot be checked externally. - If the problem (once the inverter has been switched off and back on) persists, contact customer assistance. |
| - E006 - Output OC - ● Yellow LED | Output over current: The alarm occurs when the inverter's output current exceeds the inverter's threshold for maximum output current. | <ul style="list-style-type: none"> • Error inside the inverter and cannot be checked externally. - If the problem (once the inverter has been switched off and back on) persists, contact customer assistance. |
| - E007 - IGBT Sat - ● Yellow LED | Saturation recorded on the IGBT components: The alarm occurs when one of the inverter's active devices is in a saturated state. | Once the error occurs, the inverter tries to return to normal operation. <ul style="list-style-type: none"> - Should the error occur sporadically, it may be caused by a brusque transition of the grid voltage or of the input voltage, but is not due to a malfunction by the inverter. - If the error is connected to an internal breakdown, it will continue to appear and so it is necessary to contact customer assistance. |
| - E009 - Internal error - ● Yellow LED | Error inside the inverter: Error inside the inverter | <ul style="list-style-type: none"> • Error inside the inverter and cannot be checked externally. - If the problem (once the inverter has been switched off and back on) persists, contact customer assistance. |
| - E010 - Bulk Low - ● Yellow LED | Low "Bulk" voltage (DC-DC circuit): <ul style="list-style-type: none"> • The alarm may be triggered by causes external to the inverter: a reduced input voltage on the inverter (just above the activation voltage) but which is not accompanied by a sufficient availability of power from the photovoltaic generator (typical condition of the stages with limited irradiation) | <ul style="list-style-type: none"> - If the error signal occurs sporadically, it may be due to causes external to the inverter (limited irradiation and so limited power availability from the PV generator). - If the problem occurs systematically also in conditions of high irradiation and with input voltage which is significantly higher than the activation voltage, contact customer assistance. |
| - E011 - Ramp Fail - ● Yellow LED | Long wait for "Booster" regime to start: Error internal to inverter relating to start up time for DC-DC circuit regime (Booster) | <ul style="list-style-type: none"> • Error inside the inverter and cannot be checked externally. - If the problem (once the inverter has been switched off and back on) persists, contact customer assistance. |
| - E012 - DcDc Fail - ● Yellow LED | Error in the "Booster" circuit (DC-DC side) recorded by the "Inverter" circuit (DC-AC side): Error internal to inverter relating to operation of the DC-DC circuit regime (Booster) | <ul style="list-style-type: none"> • Error inside the inverter and cannot be checked externally. - If the problem (once the inverter has been switched off and back on) persists, contact customer assistance. |



| - Code on display - Error message - Signal | Name of Alarm and Cause | Solution |
|---|--|--|
| <ul style="list-style-type: none"> - E013 - Wrong Mode - ● Yellow LED | <p>Incorrect configuration of inputs (set in parallel rather than independent): The alarm is generated solely when the inverter is configured with parallel inputs. In this particular configuration the inverter checks the input voltage of each of the two channels and if the two voltages differ by more than 20Vdc, the alarm is raised .</p> | <ul style="list-style-type: none"> • Check that the setting of the "IN MODE" switch is specifically set to "PAR" and that the bridges between the two input channels have been included. - If the configuration of the inverter is correct, check that the input strings have the usual number of standard panels of the usual brand and with the same inclination/orientation. - If both the configuration of the inverter and the characteristics of the PV generator conform with the specifications, contact customer assistance. |
| <ul style="list-style-type: none"> - E014 - Over Temp. - ● Yellow LED | <p>Excessive temperature inside the inverter: External temperature over 60°C. This parameter also depends on the power which the inverter must supply since the measurement of temperatures is done internally and is influenced by the heat dissipated by the components of the inverter itself</p> | <ul style="list-style-type: none"> • Check that the inverter is not exposed to direct sunlight. Wait for the temperatures to which the inverter is exposed to return to the operating range and for the inverter to cool down. - If the problem (once the ambient temperature has returned to the range) persists, contact customer assistance. Remember to wait the time needed to allow the inverter to cool down |
| <ul style="list-style-type: none"> - E015 - Bulk Cap Fail - ● Yellow LED | <p>Breakdown recorded on the "Bulk" capacitor: Error inside the inverter relating to a problem in the bulk capacitors.</p> | <ul style="list-style-type: none"> • Error inside the inverter and cannot be checked externally. - If the problem (once the inverter has been switched off and back on) persists, contact customer assistance. |
| <ul style="list-style-type: none"> - E016 - Inverter Fail - ● Yellow LED | <p>Error in the "Inverter" circuit (DC-AC side) recorded by the "Booster" circuit (DC-DC side): The alarm is generated when a problem is recorded in the inverter circuit (DC/AC)</p> | <ul style="list-style-type: none"> • Error inside the inverter and cannot be checked externally. - If the problem (once the inverter has been switched off and back on) persists, contact customer assistance. |
| <ul style="list-style-type: none"> - E017 - Start Timeout - ● Yellow LED | <p>Long wait for "Inverter" regime to start up: Error internal to inverter relating to start-up time for the DC-AC circuit regime (Inverter) • The alarm may be triggered by causes external to the inverter: a reduced input voltage on the inverter (just above the activation voltage) but which is not accompanied by a sufficient availability of power from the photovoltaic generator (typical condition of the stages with limited irradiation)</p> | <ul style="list-style-type: none"> - If the error signal occurs sporadically, it may be due to causes external to the inverter (limited irradiation and so limited power availability from the PV generator). - If the problem occurs systematically also in conditions of high irradiation and with input voltage which is significantly higher than the activation voltage, contact customer assistance. |
| <ul style="list-style-type: none"> - E018 - Ground Fault - ● Red LED | <p>High leakage current measured on the DC side (photovoltaic generator): The alarm is generated when, during normal operation of the inverter, a leakage current to ground is detected in the DC section of the system. It is also possible that the inverter generates the alarm E018 message also due to AC leakage currents connected to the capacitive nature of the photovoltaic generator compared to ground.</p> | <ul style="list-style-type: none"> • Measure the insulation resistance using a megohmmeter positioned between the photovoltaic field (positive terminal short-circuited at the negative pole) compared to ground. The measurement is strongly influenced by the environmental conditions, so must be made under the same conditions in which the error occurred. - If the value measured is lower than 1 megaohm, a check must be carried out by a technician/installer on the photovoltaic generator to identify and eliminate the problem. - If the value measured is higher than 1 megaohm and the error signal persists, contact customer assistance. |
| <ul style="list-style-type: none"> - E019 - Ileak sense.fail - ● Yellow LED | <p>Failure of test on sensor to measure the leakage current (DC side): Before connecting to the grid the inverter runs a self-test regarding the sensor for the leakage current. The test is carried out by "forcing", in the sensor of the leakage current, a current with a known value: the microprocessor compares the value read with the known value. The error is generated if the comparison between the read value and the known value during the test does not fall within the allowed tolerance.</p> | <ul style="list-style-type: none"> • Error inside the inverter and cannot be checked externally. By its nature, the alarm only occurs prior to connection to the grid - If the problem (once the inverter has been switched off and back on) persists, contact customer assistance. |
| <ul style="list-style-type: none"> - E020 - Self Test Error 1 - ● Yellow LED | <p>Failure of the test on the relay of the "Booster" (DC-DC circuit): Before connecting to the grid the inverter carries out internal tests. One of these tests concerns the correct operation of the booster relay. The test is carried out by "forcing" the switching of the relay and checking its operation. The error is generated if a problem is found in actioning the relay.</p> | <ul style="list-style-type: none"> • Error inside the inverter and cannot be checked externally. By its nature, the alarm only occurs prior to connection to the grid - If the problem (once the inverter has been switched off and back on) persists, contact customer assistance. |



| - Code on display - Error message - Signal | Name of Alarm and Cause | Solution |
|---|--|---|
| - E021 - Self Test Error 2 - Yellow LED | Failure of the test on the inverter's relay (DC-AC circuit): Before connecting to the grid the inverter carries out internal tests. One of these tests concerns the correct operation of the inverter relay. The test is carried out by "forcing" the switching of the relay and checking its operation. The error is generated if a problem is found in actioning the relay. | <ul style="list-style-type: none"> • Error inside the inverter and cannot be checked externally. By its nature, the alarm only occurs prior to connection to the grid - If the problem (once the inverter has been switched off and back on) persists, contact customer assistance. |
| - E022 - Self Test Error 4 - Yellow LED | Timeout of the tests undertaken on the relays inside the inverter: Execution time for the self-test carried out on the relay of the DC_AC (inverter) circuit too high. It may indicate a problem connected to the aforementioned relays | <ul style="list-style-type: none"> • Error inside the inverter and cannot be checked externally. - If the problem (once the inverter has been switched off and back on) persists, contact customer assistance. |
| - E023 - DC in error - Yellow LED | Feeding of continuous current to grid outside of range: The error is generated if the continuous component of the current supplied to the grid exceeds the threshold of 0.5% of the normal operating current. In any case the inverter is not blocked due to the E023 error, but tries to reconnect to the grid. The sporadic repetition of the error is a sign of serious grid distortions or sharp irradiation changes, while systematic repetition of the error signal will indicate a breakdown on the inverter | Once the error occurs, the inverter tries to return to normal operation. <ul style="list-style-type: none"> - Should the error occur sporadically, it may be caused by a brusque transition of the grid voltage or of the input voltage, but is not due to a malfunction by the inverter. - If the error is connected to an internal breakdown, it will continue to appear and so it is necessary to contact customer assistance. |
| - E024 - Internal error - Yellow LED | Error inside the inverter: Error inside the inverter | <ul style="list-style-type: none"> • Error inside the inverter and cannot be checked externally. - If the problem (once the inverter has been switched off and back nor) persists, contact customer assistance. |
| - E025* - Riso Low - Yellow LED *not visualised on display | Low value of insulation resistance: Before connecting to the grid the inverter measures the insulation resistance of the PV generator compared to ground. Should the measurement of the insulation resistance be below 1Mohm, the inverter does not connect to the grid and shows the "Riso Low" error. The causes may be: - PV panel(s) damaged; - Junction box(es) of the panels not correctly sealed, so as to permit infiltration by water and/or humidity; - Problems in connections between panels (not perfectly fit); - Poor quality of cable joints; - Presence in the DC section of unsuitable or damaged overvoltage surge arresters outside the inverter (reduced ignition voltage compared to the characteristics of the strings of the PV generator); - Presence of humidity inside any junction box | <ul style="list-style-type: none"> • Measure the insulation resistance using a megohmmeter positioned in the photovoltaic field (positive terminal short-circuited at the negative pole) compared to ground. The measurement is strongly influenced by the environmental conditions, so must be made under the same conditions in which the error occurred. - If the value measured is lower than 1 megaohm, a check must be carried out by a technician/installer on the photovoltaic generator to identify and eliminate the problem. - If the value measured is higher than 1 megaohm and the error signal persists, contact customer assistance. |
| - E026 - Vref Error - Yellow LED | Internal reference voltage outside of range: Wrong measurement of reference voltage inside inverter | <ul style="list-style-type: none"> • Error inside the inverter and cannot be checked externally. - If the problem (once the inverter has been switched off and back on) persists, contact customer assistance. |
| - E027 - Error Meas V - Yellow LED | Grid voltage outside of range: Error in the internal measurement of grid voltage (set by law) in order to have a redundant measurement (2 measurements on the same parameter made by two different circuits) | <ul style="list-style-type: none"> • Error inside the inverter and cannot be checked externally. - If the problem (once the inverter has been switched off and back on) persists, contact customer assistance. |
| - E028 - Error Meas F - Yellow LED | Grid frequency outside of range: Error in the internal measurement of grid frequency (set by law) in order to have a redundant measurement (2 measurements on the same parameter made by two different circuits) | <ul style="list-style-type: none"> • Error inside the inverter and cannot be checked externally. - If the problem (once the inverter has been switched off and back on) persists, contact customer assistance. |
| - E029 - Mid Bulk OV - Yellow LED | Internal over voltage on the measurement of the "Mid bulk": Error internal to the inverter (only triphase models) | <ul style="list-style-type: none"> • Error inside the inverter and cannot be checked externally. - If the problem (once the inverter has been switched off and back on) persists, contact customer assistance. |



| - Code on display - Error message - Signal | Name of Alarm and Cause | Solution |
|---|---|---|
| - E030 - Error Meas I leak - ● Yellow LED | High leakage current (DC side): Error in the internal measurement (made when the inverter is grid connected) of the leakage current of the DC side (PV generator) compared to ground (set by law) in order to have a redundant measurement (2 measurements on the same parameter made by two different circuits) | • Error inside the inverter and cannot be checked externally. - If the problem (once the inverter has been switched off and back on) persists, contact customer assistance. |
| - E031 - Error Read V - ● Yellow LED | Output relay damaged: Measurement of internal voltage on heads of the output relay outside of range. There is too great a difference in voltage between the input and output of the grid connection relay. | • Error inside the inverter and cannot be checked externally. - If the problem (once the inverter has been switched off and back on) persists, contact customer assistance. |
| - E032 - Error Read I - ● Yellow LED | Imbalanced output currents: Measurement of the unbalance in the output voltage (made across the three phases) outside of range (only in triphase models) | • Error inside the inverter and cannot be checked externally. - If the problem (once the inverter has been switched off and back on) persists, contact customer assistance. |
| - E033 - UTH - ● Yellow LED | Low ambient temperature: Temperature outside the inverter below -25°C | • Wait for the temperatures to which the inverter is exposed to return to the operating range. - If the problem persists, contact customer assistance. Remember to wait the time needed to allow the inverter to warm up |
| - E034 - Interlock fail - ● Yellow LED | “IGBT” circuitry not ready: Error inside the inverter | • Error inside the inverter and cannot be checked externally. - If the problem (once the inverter has been switched off and back on) persists, contact customer assistance. |
| - E035* - Remote Off - ● Yellow LED *not visualised on display | Inverter awaiting “remote ON” command: The inverter has been switched off remotely (remote OFF) and remains awaiting the signal which will switch it back on (Remote ON) | • Switch back on the inverter remotely. If the unit does not switch back on, disable the remote off/on function and switch the equipment off completely and subsequently switch it back on. - If the problem (once the Remote ON/OFF function from the display has been reactivated) persists, contact customer assistance. |
| - E036 - Vout Avg error - ● Yellow LED | Average of the measurements of grid voltage outside of range: The average value of the grid voltage (sampled every 10 minutes) does not fall within the permitted ranges. The grid voltage in the point connected to the inverter is too high. This may be caused by too high a grid impedance. In the final stage of the timeout, the inverter limits the power to check whether the grid voltage has stabilised into regular parameters. If this does not happen, the inverter disconnects from the grid | • Check the grid voltage in the connection point to the inverter. - If the grid voltage differs from the range due to the conditions of the distribution grid, ask the operator to adjust the grid voltage. If the operator authorises a change to the inverter's parameters, agree the new limits with customer assistance |
| - E037 - Riso Low - ● Red LED | Low value of the insulation resistance (only with the “Amorphous” mode activated): This error can occur only should the “Amorphous” mode be on. This function is on only in inverters equipped with a grounding kit and serves to monitor the voltage at the heads of the grounding resistance. The error occurs when the voltage at the heads of the resistance connected between ground and the pole of the photovoltaic generator exceeds 30V for more than 30 minutes or 120V for more than one second. | • Check for the presence and correct contact between the two terminals of the grounding resistance installed inside the inverter • Measure the insulation resistance using a megohmmeter positioned in the photovoltaic field (positive terminal short-circuited at the negative pole) compared to ground. The measurement is strongly influenced by the environmental conditions, so must be made under the same conditions in which the error occurred. - If the value measured is lower than 1 megaohm, a check must be carried out by a technician/installer on the photovoltaic generator to identify and eliminate the problem. - If the value measured is higher than 1 megaohm and the error signal persists, contact customer assistance. |
| E046 - String self test fail - ⊗ No LED | Error during the automatic check of the string voltages (only in models with the “fuse-control” board): In some inverter models it is possible to carry out the check test of the polarity of the strings connected to the input (e.g.:TRIO-20.0/27.6kW). This error signal occurs when, during the test stage, an inverted string is recorded | • Section the inverter and check the polarity of the string(s) which the inverter has recorded as inverted. - Once all the strings have been correctly connected, activate the system once again; the inverter will once again check the correct polarity of the string inputs at the end of which it will carry out the checks for the grid connection. - If the problem (once the inverter has been switched off and back on) persists, contact customer assistance. |
| E049 - AC FF Error - ● Yellow LED | Error in the “AC feed-forward” circuit: Error inside the inverter | • Error inside the inverter and cannot be checked externally. - If the problem (once the inverter has been switched off and back on) persists, contact customer assistance. |



| - Code on display - Error message - Signal | Name of Alarm and Cause | Solution |
|---|--|---|
| E056 - Over Temp. (from external box) - ● Yellow LED | Excessive temperature measured inside the inverter's wiring box: High internal temperature. This error relates to the temperature measured on external boxes (e.g.:TRIO-20.0/27.6kW). | <ul style="list-style-type: none"> • Check that the inverter is not exposed to direct sunlight. Wait for the temperatures to which the inverter is exposed to return to the operating range and for the inverter to cool down. - If the problem (once the ambient temperature has returned to the range) persists, contact customer assistance. Remember to wait the time needed to allow the inverter to cool down |
| E057 - Vbulk reading error - ● Yellow LED | Input voltage (Vin) higher than booster voltage (Vbulk): The error occurs if the input voltage exceeds the Bulk voltage (voltage on the DC-DC circuit inside the inverter) | <ul style="list-style-type: none"> • It is necessary to measure the input voltage inside the inverter with a voltmeter. - If it is higher than the maximum voltage of the operating range, the alarm is genuine and it is necessary to check the configuration of the PV generator. If the voltage has also exceeded the maximum input threshold the inverter could be damaged. - If it is lower than the maximum voltage of the operating range, the alarm is caused by an internal malfunction and it is necessary to contact customer assistance. |
| E058 - Pin vs Pout check error - ● Yellow LED | Error in the check of Pin vs Pout: The error occurs if the difference between the measured value of input power and that of output power is greater than the limit imposed internally to the inverter. | <ul style="list-style-type: none"> • Error inside the inverter and cannot be checked externally. - If the problem (once the inverter has been switched off and back on) persists, contact customer assistance. |

Power limitation messages

The equipment can signal possible output power limitations which may occur on the basis of:





- settings made by the user
- settings required by the grid standard of the country of installation
- protective devices inside the inverter

The notices of messages are shown on the display.

The following table gives the complete list of power limitation messages relating to string inverters. Some messages may not be used depending on the inverter model installed.



| - Message on display - Signal | Name of Derating and Cause | Solution |
|--|--|---|
| - LIMxxx% CODE:00 - ▲ Display symbol b6 | Power limitation: The message indicates that the user has set an output power limitation for the inverter. LIM xxx% = Power reduction percentage Examples: LIM 100% = no power limitation LIM 50% = limitation to 50% of the output nominal power | <ul style="list-style-type: none"> • Check the limitation value set in the "Settings > Power Limitation" menu |
| - LIMxxx% CODE:01 - ▲ Display symbol b6 | Power limitation for over-frequency: The message indicates that the user has set a power limitation due to over frequency in order to reduce the maximum output power of the inverter when the grid frequency exceeds certain limits. LIM xxx% = Power reduction percentage Examples: LIM 100% = no power limitation LIM 50% = limitation to 50% of the output nominal power | <ul style="list-style-type: none"> • Check the limitation value set in the "Settings > Service > OF Derating" menu |

| - Message on display - Signal | Name of Derating and Cause | Solution |
|---|--|---|
| - LIMxxx% CODE:02 -  Display symbol <u>b6</u> | Power limitation for over-voltage: The message indicates that the user has set a power limitation due to over voltage (parameter U >(10 min)) in order to reduce the maximum output power of the inverter when the reading of the average grid voltage exceeds certain limits. The sampling of readings is done every 10 minutes (U>(10min)). LIM xxx% = Power reduction percentage Examples: LIM 100% = no power limitation LIM 50% = limitation to 50% of the output nominal power | <ul style="list-style-type: none"> • Check the limitation value set in the “Settings > Service > U > (10 min) Der.” menu |
| - LIMxxx% CODE:03 -  Display symbol <u>b6</u> | Anti-islanding power limitation: The message indicates that a power limitation is active since an "islanding" condition has been recorded. LIM xxx% = Power reduction percentage Examples: LIM 100% = no power limitation LIM 50% = limitation to 50% of the output nominal power | <ul style="list-style-type: none"> • If the inverter remains connected to the grid and the limitation is active, contact customer assistance |
| - LIMxxx% CODE:04 -  Display symbol <u>b6</u> | Power limitation due to low grid voltage: The message indicates that an output power limitation may occur since a low grid voltage (AC) condition has been recorded. LIM xxx% = Power reduction percentage Examples: LIM 100% = no power limitation LIM 50% = limitation to 50% of the output nominal power | <ul style="list-style-type: none"> • Check that the grid voltage is lower than the minimal voltage. Should this condition persist, contact the grid operator to resolve the problem. |
| - LIMxxx% CODE:05 -  Display symbol <u>b7</u> | Power limitation due to excess temperature: The message indicates that a power limitation is active since an excess temperature condition has been recorded inside the inverter (This parameter depends also on the power which the inverter must provide since the measurement of temperatures is taken internally and is influenced by the heat dissipated by the components of the inverter itself). LIM xxx% = Power reduction percentage Examples: LIM 100% = no power limitation LIM 50% = limitation to 50% of the output nominal power | <ul style="list-style-type: none"> • Check that the inverter is not exposed to direct sunlight. Wait for the temperatures to which the inverter is exposed to return to the operating range and for the inverter to cool down. - If the problem (once the ambient temperature has returned within the range) persists, contact customer assistance. |
| - LIMxxx% CODE:06 -  Display symbol <u>b6</u> | Power limitation for input over-voltage: The message indicates that a power limitation is active since an input over voltage (AC) has been recorded. LIM xxx% = Power reduction percentage Examples: LIM 100% = no power limitation LIM 50% = limitation to 50% of the output nominal power | <ul style="list-style-type: none"> • It is necessary to measure the input voltage inside the inverter with a voltmeter. - If it is higher than the maximum voltage of the operating range, the alarm is genuine and it is necessary to check the configuration of the PV generator. If the voltage has also exceeded the maximum input threshold the inverter could be damaged. - If it is lower than the maximum voltage of the operating range, the alarm is caused by an internal malfunction and it is necessary to contact customer assistance. |



Registration on “Registration” website and calculation of second-level password (Service Menu)

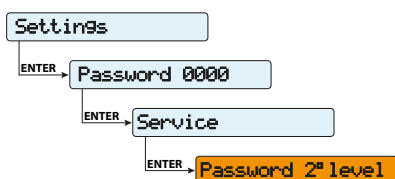

In order to obtain the second-level password needed to access the inverter's service menu, it is necessary to go through the following stages:

Stage 1 - Collection of information relating to the inverter.

Collect the following information relating to each inverter for which you wish to have a password:

- **S/N** - Serial number of the inverter. This information can be found on the label giving the identity details of the inverter or on the display by accessing the “INFORMATION” menu→Serial No.”

The serial number consists of 6 digits (the last 6 in models with a label giving a 10-digit S/N)

- **WK** - Production week. This information can be found on the label giving the identity details of the inverter or on the display by accessing the “INFORMATION” menu→Serial No.”

The production week consists of 4 figures, indicating the week (first 2 digits) and the year of production (last 2 digits)

- **Update Version** - This information is available only for some inverter models and can be found on the display by accessing the menu “INFORMATION→Firmware”.

Stage 2 - Registration on <https://registration.abbsolarinverters.com>

- Go online and access <https://registration.abbsolarinverters.com>

- Set the desired language and click on the specific icon to start registration

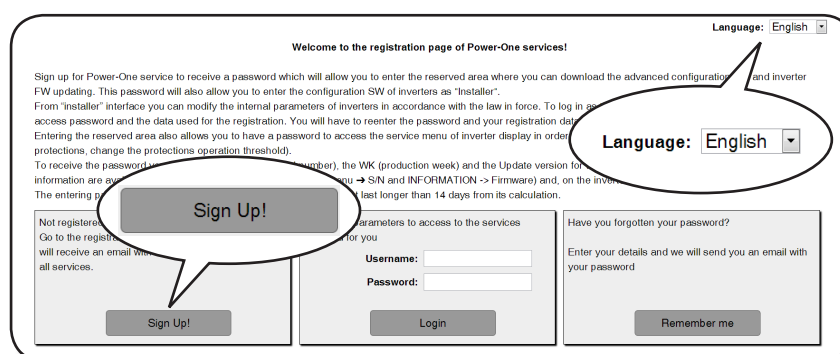

- Insert the personal data requested and end the registration stage

- An email will be sent to the email address used with a link to complete the registration process.

- Once the registration process is over, a further email will be sent with the password to access the website.



The password obtained enables access also to the advanced “Installer” mode present on the configuration software for inverters. The configuration software can be downloaded in a specific section of the website <https://registration.abbsolarinverters.com>

Stage 3 - Request for second level password

- Go online and access <https://registration.abbsolarinverters.com>
- Insert the Username (corresponding to the email used during registration) and the Password obtained at the end of Stage 2

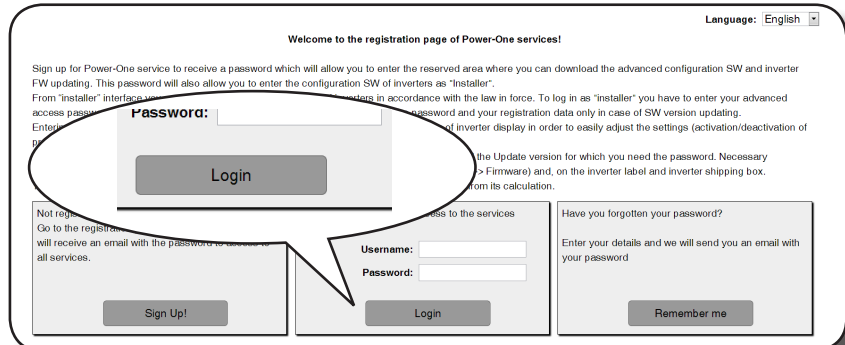

- Access the section dedicated to requesting the second-level password

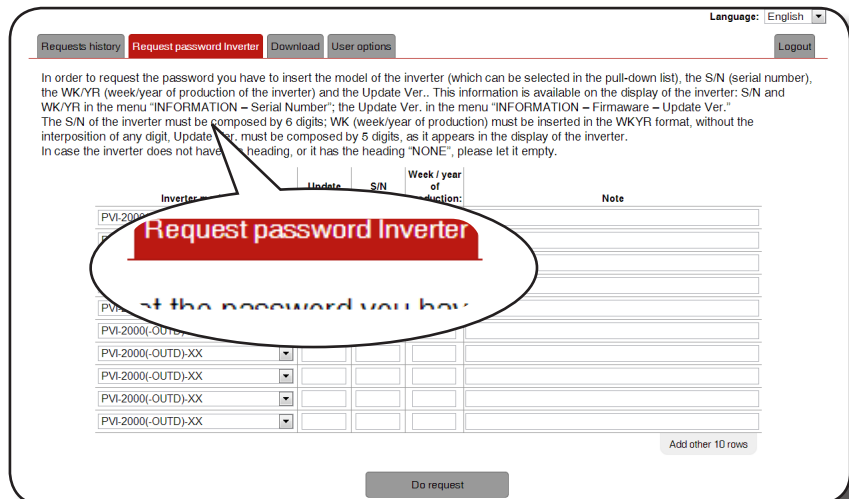

- Choose the inverter model from the drop-down list and insert Update Ver., Serial Number and Week of Production of the inverter which were obtained previously (Stage 1)

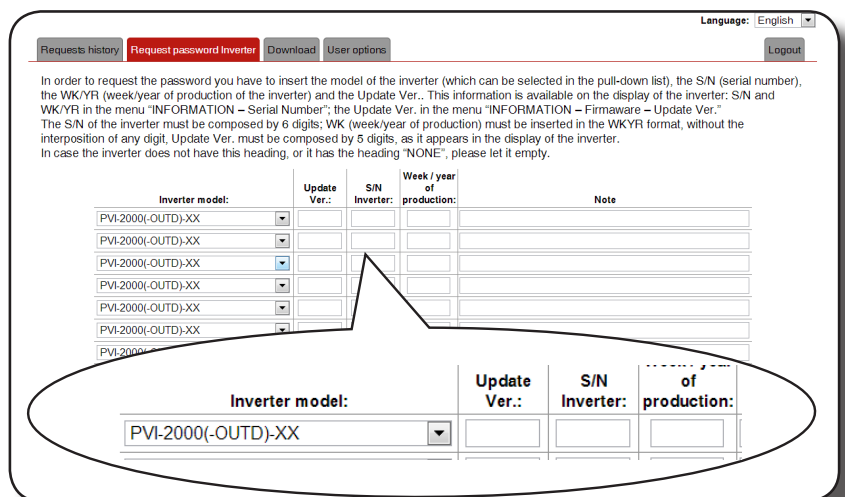

- Click on icon to request password.

Language: English

Requests history Request password Inverter Download User options Logout

In order to request the password you have to insert the model of the inverter (which can be selected in the pull-down list), the S/N (serial number), the WK/YR (week/year of production of the inverter) and the Update Ver.. This information is available on the display of the inverter: S/N and WK/YR in the menu "INFORMATION – Serial Number"; the Update Ver. in the menu "INFORMATION – Firmware – Update Ver."
The S/N of the inverter must be composed by 6 digits; WK (week/year of production) must be inserted in the WKYR format, without the interposition of any digit, Update Ver. must be composed by 5 digits, as it appears in the display of the inverter.
In case the inverter does not have this heading, or it has the heading "NONE", please let it empty.

| Inverter model: | Update Ver.: | S/N Inverter: | Week / year of production: | Note |
|--------------------|--------------|---------------|----------------------------|------|
| UNO-2.04-OUTD | 12345 | 123456 | 0513 | |
| PVI-3.0-OUTD-XX | | 987654 | 0412 | |
| TRIO-27.6-TL-OUTD | 13052 | 564789 | 4812 | |
| PVI-2000(-OUTD)-XX | | | | |
| PVI-2000(-OUTD)-XX | | | | |
| PVI-2000(-OUTD)-XX | | | | |
| PVI-2000(-OUTD)-XX | | | | |
| PVI-2000(-OUTD)-XX | | | | |
| PVI-2000(-OUTD)-XX | | | | |
| PVI-2000(-OUTD)-XX | | | | |
| PVI-2000(-OUTD)-XX | | | | |

Add other 10 rows

Do request

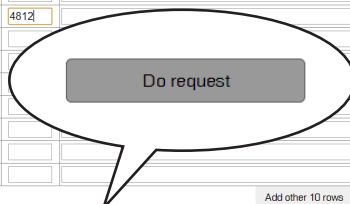

Should there be an error in inputting data, the fields containing the error will be highlighted in red. If, on the other hand, the data are correct, the passwords will be shown in a new window and at the same time sent to the email address used for registration.



The second-level password enables access to the service menu which allows the inverter's sensitive parameters to be changed. Proceed to changing the aforementioned parameters only when requested by the grid operator or by customer assistance.



Resetting the time remaining to change the grid standard

From the time a valid grid standard is entered and the inverter is turned on, a period of 24 hours is available to modify the grid standard setting.



The 24 hours are counted only when the inverter is turned on. Check that the date and time are set correctly. Otherwise it may not be possible to access the "Service" menu to reset the timer.

After this period of time the system will block changes to the standard; and it will be necessary to carry out the following procedure to reset the remaining time and obtain another 24 hours to select a new grid standard:

Settings

1. Access the "SETTINGS" menu by entering the first-level password (default 0000)

Service

2. Access the "Service" sub-menu by entering the second-level password



The password to access the "Service" menu can be obtained by registering at the site <https://registration.abbsolarinverters.com>

Before accessing the site it will be necessary to locate the information utilized to compute the password:

Inverter model

Serial number and week of manufacture

Update field

The "Update" field is available only if the firmware of the inverter has been previously updated. If not available leave the field blank when requesting the password

The password obtained is valid for a period of 15 days



Reset Country S.

3. Select "Reset Country S." to reset the 24 hours of operation in which the grid standard may be modified..

Replacing the input fuses (version -FS)



Using fuses with inappropriate specifications may irreparably damage the unit. Any consequential damage to the inverter is not covered by the warranty.



In case of damage of one or more input fuses, the inverter (not being able to monitor the status of fuses) will continue to export energy to the grid without signaling any alarm.

The input fuses ⑬ must be replaced when:

- 1. One or more input fuses have been damaged.**
- 2. The fuses fitted on the inverter are not appropriate for the employed photovoltaic system.**

The following table shows the specifications of the replacement fuse.

| | |
|------------------------------|------------|
| Mechanical dimensions | 10x38mm |
| Nominal voltage | 1000Vdc |
| Nominal current | 20A max. |
| Standard | IEC60269-6 |

To replace the input fuses ⑬ follow the procedure below:

- 1. Disconnect the AC line by opening any external disconnect switches.**
- 2. Disconnect the DC line by opening the disconnect switch ⑯ integrated in the inverter**



By only opening the integrated DC disconnect switch ⑯ in the inverter, the fuse board is still maintained at the input voltage. Disconnect any external disconnect switches on the DC line or obscure the photovoltaic panels, then disconnect the input quick fit connectors.

- 3. Remove the inverter's front panel by unscrewing the screws on the panel with the Torx T20 wrench provided.**
- 4. Use a multimeter to ensure that no voltage is present between the positive and negative poles of the DC inputs.**



5. Remove the fuse holder by pressing its handle.
6. Extract the fuse to be replaced from the fuse holder by releasing the retaining clip.
7. Insert the replacement fuse into the fuse holder, checking that it is secured by the retaining clip.
8. Insert the fuse holder back in its original position.

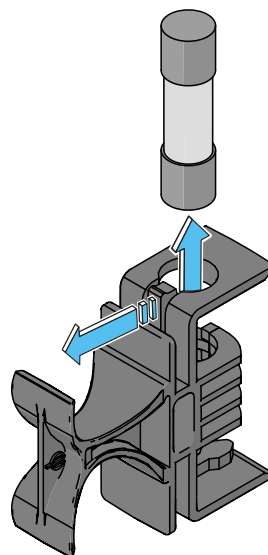
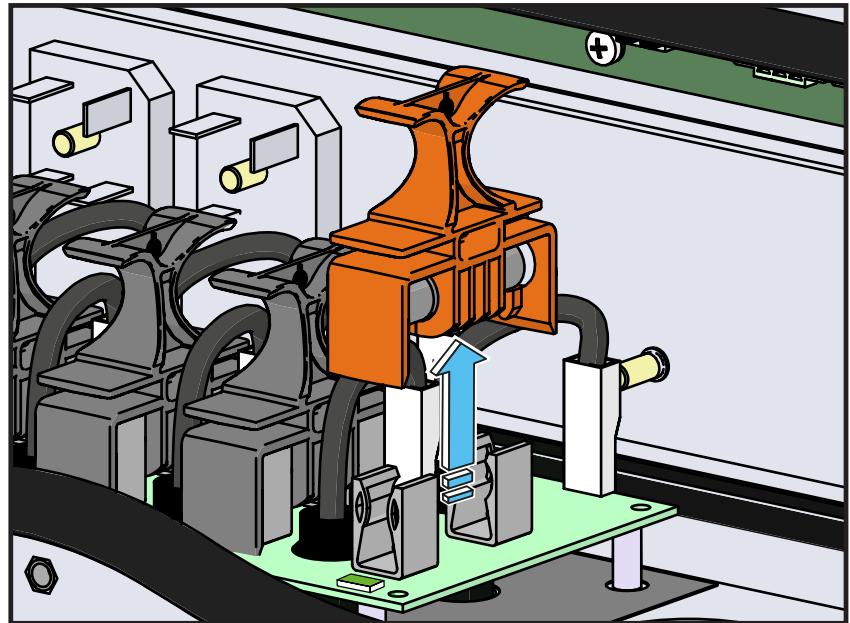

Replacement of the buffer battery

Replacement of the buffer battery ⑱ may be necessary in case of:

1. Error signal on display
2. Reset of the date and time settings

The battery is of the **CR2032 type** and is installed on the motherboard ⑱.

Procedure to replace the buffer battery:

1. Disconnect the inverter by removing the AC and DC disconnect switches
2. Open the front cover
3. Remove the battery to be replaced
4. Install the new battery, taking care to handle it with insulating gloves in order not to compromise the charge and respecting the polarity shown on the diagram on the motherboard.

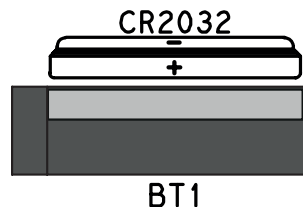
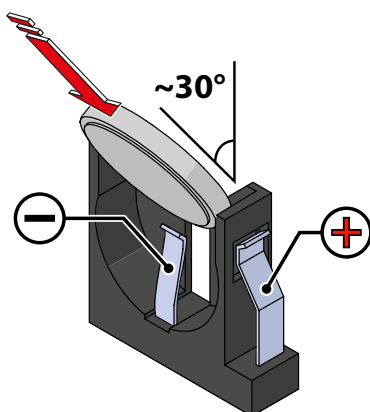

5. Close the front cover
6. Carry out the procedure for the commissioning of the inverter



Verification of ground leakage

In the presence of anomalies or report of ground fault (where provided), there may be a ground leakage from the PV generator (DC side).

To check this, measure the voltage between the positive pole and ground and between the negative pole (of the PV generator) and ground using a voltmeter whose input accepts a voltage sufficient for the dimensions of the photovoltaic generator.

Behaviour of a system without leakage

Due to the capacitive effect of the PV generator, during the first moments that the voltmeter is connected between one of the two poles and ground, it will measure a voltage of about $V_{oc}/2$, which will tend to stabilize to around 0V if there is no ground leakage, as shown in the graph below:

The internal resistance of the voltmeter tends to zero the voltage present on the PV generator due to the capacitive effect.

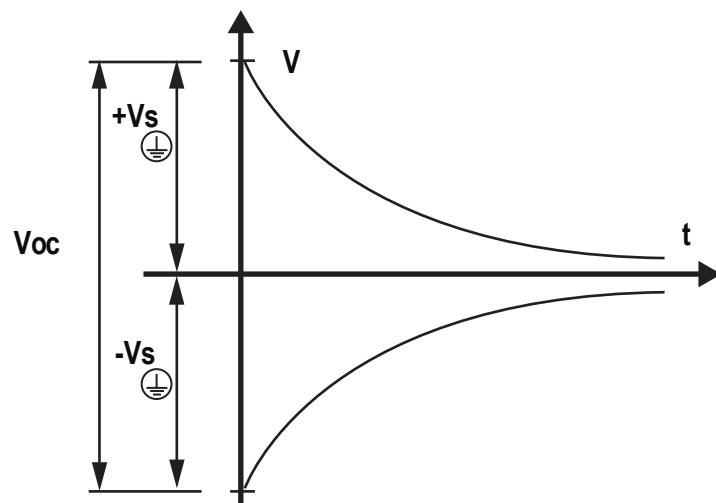

How to make the measurement:

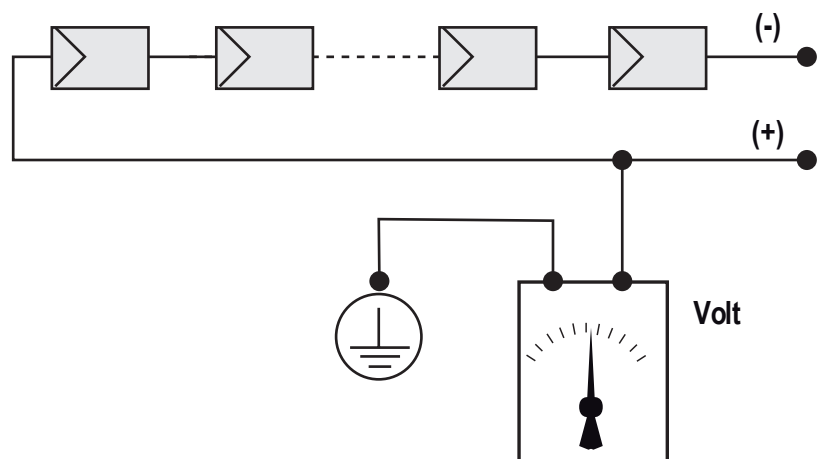

Behaviour of a system with leakage

If the voltage measured between one of the two poles and ground does not tend to 0V and stabilizes on a value, there is a ground leakage from the PV generator.

Example: When the measurement is made between positive pole and ground, a voltage of 200V is measured.

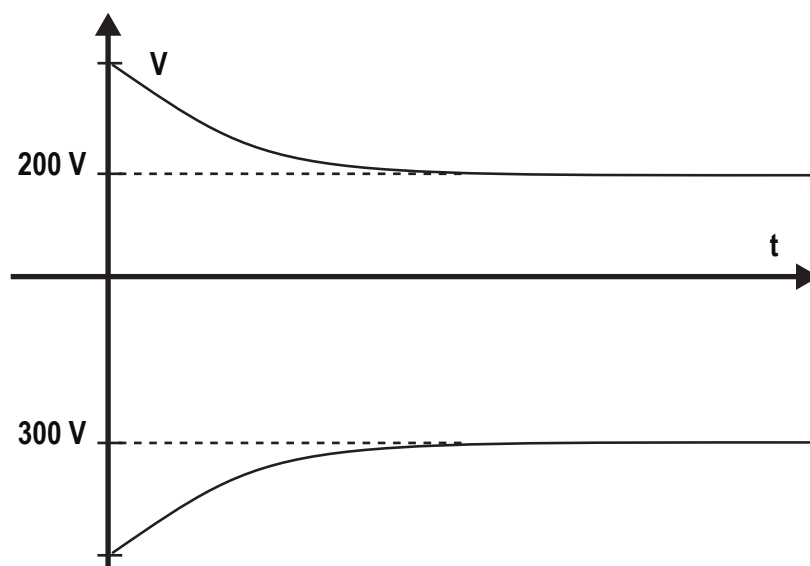

This means that if the system is made up of 10 modules in series and each one supplies 50V, the leakage can be located between the 4th and 5th PV module.

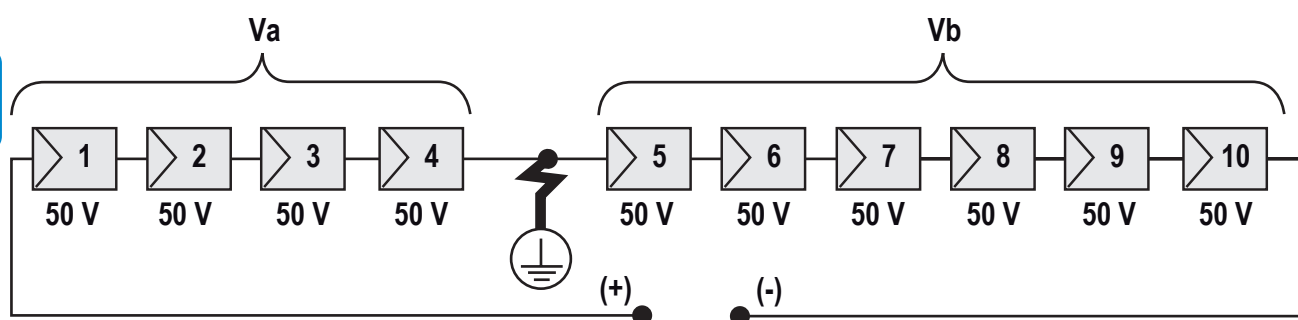

V_a = voltage measured between + pole and \oplus = 200V

V_b = voltage measured between - pole and \oplus = 300V

In all measurements with \oplus , the ground of the inverter is indicated.

Measuring the insulation resistance of photovoltaic generator

To measure the insulation resistance of the PV generator compared to ground \oplus , the two poles of the PV generator must be short-circuited (using a suitably sized switch).

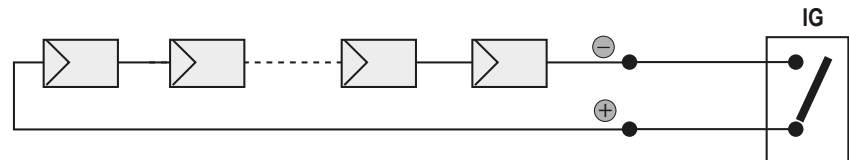

Once the short-circuit has been made, measure the insulation resistance (R_{iso}) using a megohmmeter positioned between the two shorted poles and ground (of the inverter).

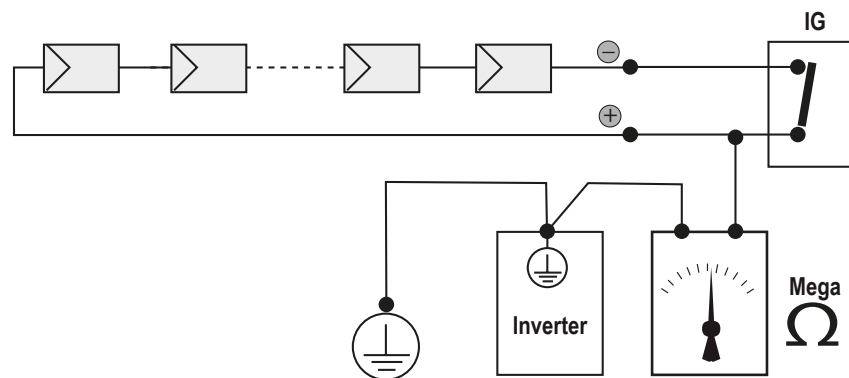

-TL MODELS (transformerless). If the measured insulation resistance (R_{iso}) is less than 1Mohm the inverter does not connect to the grid due to a low insulation of photovoltaic generator respect to ground.

-I MODELS (with high frequency transformer). If the measured insulation resistance (R_{iso} in case of input poles floating respect to ground or $QF=1$ if the one of input poles is grounded) is less than 0.2Mohm the inverter does not connect to the grid due to a low insulation of photovoltaic generator respect to ground.



The insulation resistance is affected by the environmental conditions the PV generator is in (E.g.: photovoltaic module wet from dump or rain), and therefore the measurement must be made immediately after the anomaly

Storage and dismantling

Storage of the equipment or long period of non-use

If the equipment is not being currently used or is to be stored for a long period of time, check that it is correctly packed and contact ABB for storage instructions.

The equipment must be stored in well-ventilated indoor areas and in an environment that doesn't damage the components of the equipment.

Restarting after a long period of non-use requires the equipment be inspected and, in some cases, the removal of oxidation and dust will be required that has settled inside the equipment.

Dismantling, decommissioning and disposal

ABB CANNOT be held responsible for disposal of the equipment (displays, cables, batteries, accumulators, etc.). The customer must dispose of these substances, which are potentially harmful to the environment, in accordance with the regulations in force in the country of installation.

If the equipment is dismantled, in order to dispose of the products that it is composed of, you must adhere to the regulations in force in the country of destination to avoid a hazardous disposal situation.

Dispose of the various types of materials that are part of the equipment at facilities that are suitable for the purpose.

Table: disposal of components

| COMPONENT | CONSTRUCTION MATERIAL |
|---------------------------------|-------------------------|
| Frame, brackets, supports | Arc-welded steel FE37 |
| Casing or covers | ABS, plastic |
| Paint and | RAL |
| Gaskets and seals | Rubber / Teflon / Viton |
| Electrical cables | Copper / Rubber |
| Conduits | Polyethylene / Nylon |
| Back-up battery | Nickel / Lead/ Lithium |



Further information

For more information on ABB solar products and services,
visit www.abb.com/solarinverters

Contact us

www.abb.com/solarinverters