



PYLONTECH



Lithium-Ion Phosphate Battery

Pelio-L-5.12

Operation Manual

Information Version: 5PMPA08-00124

SD22PE51010701

This manual introduces Pelio from Pylontech. Pelio-L-5.12 is a Lithium-Ion Phosphate Battery Storage System. Please read this manual before you install the battery and follow the instruction carefully during the installation process. Any confusion, please contact Pylontech for advice and clarification.

1. Safety	3
1.1 Symbol.....	3
1.2 EU Declaration of Conformity.....	5
1.3 Safety Precautions.....	5
1.4 Before Connecting.....	6
1.5 In Using.....	6
2. Introduction	8
2.1 Features.....	8
2.2 Specification.....	9
2.3 Equipment interface instruction.....	11
3. Safe handling of lithium batteries guide	15
3.1 Schematic diagram of solution.....	15
3.2 Tools.....	15
3.3 Safety Gear.....	16
4. Installation and Operation	17
4.1 Package List.....	17
4.2 System Working Environments Checking.....	20
4.2.1 Cleaning.....	20
4.2.2 Ventilation.....	20
4.2.3 Grounding System.....	20
4.2.4 Clearance.....	20
4.3 Preparation Before Installation.....	21
4.3.1 Operating Precautions.....	21
4.3.2 Plan the Installation Site.....	21
4.3.3 Unboxing the Package.....	22
4.4 Installation.....	22
4.4.1 Wall Mounting.....	22
4.4.2 Ground Mounting.....	23

4.4.3 Battery installation	24
4.5 Power cable connection	26
4.6 Communication cable connection	28
4.6.1 LINK cable	28
4.6.2 CAN and RS485 cable	29
4.7 Ground cable connection	30
4.8 Plastic covers	31
4.9 Power on	32
4.10 Power off	33
4.11 USB interface	34
4.12 Wi-Fi interface	35
4.13 Power connection planning	35
4.14 Multi stack connection	38
5 Trouble shooting	39
6 Remarks	44

1. Safety

Read all safety instructions carefully prior to any work and observe them when working on the battery.





Incorrect operation may cause:









- Injury or death to the operator or a third party
- Damage to the system hardware and other properties belonging to the operator or a third party.

Skills of Qualified Personnel:

- Training in the installation and commissioning of the electrical system, as well as the dealing with hazards.
- Knowledge of this manual and other related documents.
- Knowledge of the local regulations and directives.

1.1 Symbol

	Danger!
	Caution! Reminding. Safety related information. Risk of battery system failure or life cycle reduces.
	Do not reverse connection the positive and negative.
	Do not place at the children and pet touchable area.
	Warning electric shock.

	<p>Warning Fire. Do not place near flammable material</p>
	<p>Read the product and operation manual before operating the battery system!</p>
	<p>Grounding.</p>
	<p>Recycle label.</p>
	<p>The certificate label for EMC.</p>
	<p>The certificate label for UKCA.</p>
	<p>Label for Waste Electrical and Electronic Equipment (WEEE) Directive (2012/19/EU)</p>
	<p>The certificate label for Safety by TÜV Rheinland.</p>
	<p>The certificate label for Safety by TÜV Rheinland.</p>

1.2 EU Declaration of Conformity

within the scope of the EU directives

- Directive 2014/30/EU relating to electromagnetic compatibility (EN IEC 61000-6-2:2019, EN61000-6-3:2007/A1:2011)
- Radio Equipment Directive 2014/53/EU (22.5.2014 L 153/62) (RED)
- Restriction of the use of certain hazardous substances 2011/65/EU (L 174/88, June 8,2011) and 2015/863/EU (L 137/10, March 31,2015) (RoHS)
- Waste electrical and electronic equipment 2012/19/EU (L 197/38, 24.7.2012) (WEEE)

Pylon Technologies Co., Ltd. confirms herewith that the products described in this document are in compliance with the fundamental requirements and other relevant provisions of the above mentioned directives. The entire EU Declaration of Conformity can be found at en.pylontech.com.cn.

1.3 Safety Precautions



Reminding

- 1) It is important and necessary to read the user manual carefully before installing or using battery. Failure to do so or to follow any of the instructions or warnings in this document can result in electrical shock, serious injury, or death, or can damage battery, potentially rendering it inoperable, which is out of product warranty scope.
- 2) If the battery is stored for long time, it is required to charge them every six months, charge the SOC to no less than 90%
- 3) Battery needs to be recharged within 12 hours, after fully discharged.
- 4) Do not connect power terminal reversely.
- 5) All the battery power terminals must be disconnected for maintenance.
- 6) Please contact the supplier within 24 hours if there is something abnormal.
- 7) Do not use cleaning solvents to clean battery.
- 8) Do not expose battery to flammable or harsh chemicals or vapors.
- 9) Do not connect battery with PV solar wiring directly.

- 10) Any foreign object is prohibited to insert into any part of battery.
- 11) The warranty claims are excluded for direct or indirect damage due to items above.

1.4 Before Connecting



Warning

- 1) After unpacking, please check product and packing list first, if product is damaged or lack of parts, please contact with the local retailer.
- 2) Before installation, be sure to cut off the grid power and make sure the battery is in the turned-off mode.
- 3) Wiring must be correct, do not mistake the positive and negative cables, and ensure no short circuit with the external device.
- 4) It is prohibited to connect the battery and AC power directly.
- 5) The embedded BMS in the battery is designed for **51.2Vdc**, please DO NOT connect battery in series.
- 6) Battery must connect to ground and the resistance must be less than 0.1Ω
- 7) Please ensured the electrical parameters of battery system are compatible to related equipment.
- 8) Keep the battery away from water and fire.

1.5 In Using

- 1) If the battery system needs to be moved or repaired, the power must be cut off and the battery shall be completely shutdown.
- 2) It is prohibited to connect the battery with different type of battery.
- 3) It is prohibited to connect batteries with faulty or incompatible inverter.
- 4) It is prohibited to disassemble the battery.
- 5) In case of fire, dry powder fire extinguisher or vast amount of water can be used.
- 6) Please do not open, repair or disassemble the battery except staffs from Pylontech or authorized by Pylontech. We do not undertake any consequences or related responsibility which because of violation of safety operation or violating of design, production and equipment safety standards.

7) DO NOT connect in parallel with US series, UP series and other 48Vdc product from Pylontech.

2. Introduction

Pelio-L-5.12 is the brand new 51.2V DC energy storage system developed by Pylontech, it can be used to support reliable power for residence and is a good partner for environmental life.

2.1 Features

- 1) NEW: Support 24/7 online monitor with WIFI connection.
- 2) NEW: Support service and upgrade via USB interface.
- 3) High power output.
- 4) Build-in soft-start able to reduce current strike when start from battery.
- 5) Dual active protection on BMS level.
- 6) Support upgrade battery module from upper controller via CAN or RS485 communication.
- 7) Enable 95% depth of discharge, available for the inverter which completely follow Pylontech latest protocol to operate.
- 8) The module is non-toxic, non-pollution and environmentally friendly.
- 9) Cathode material is made from LiFePO₄ with safety performance and long cycle life.
- 10) Battery management system (BMS) has protection functions including over-discharge, over-charge, over-current and high/low temperature.
- 11) The system can automatically manage charge and discharge state and balance voltage of each cell.
- 12) Flexible configuration, multiple battery modules can be in parallel for expanding capacity and power
- 13) Adopted self-cooling mode rapidly reduced system entire noise
- 14) The module has less self-discharge, up to 6 months shelf, no memory effect, excellent performance of shallow charge and discharge

2.2 Specification

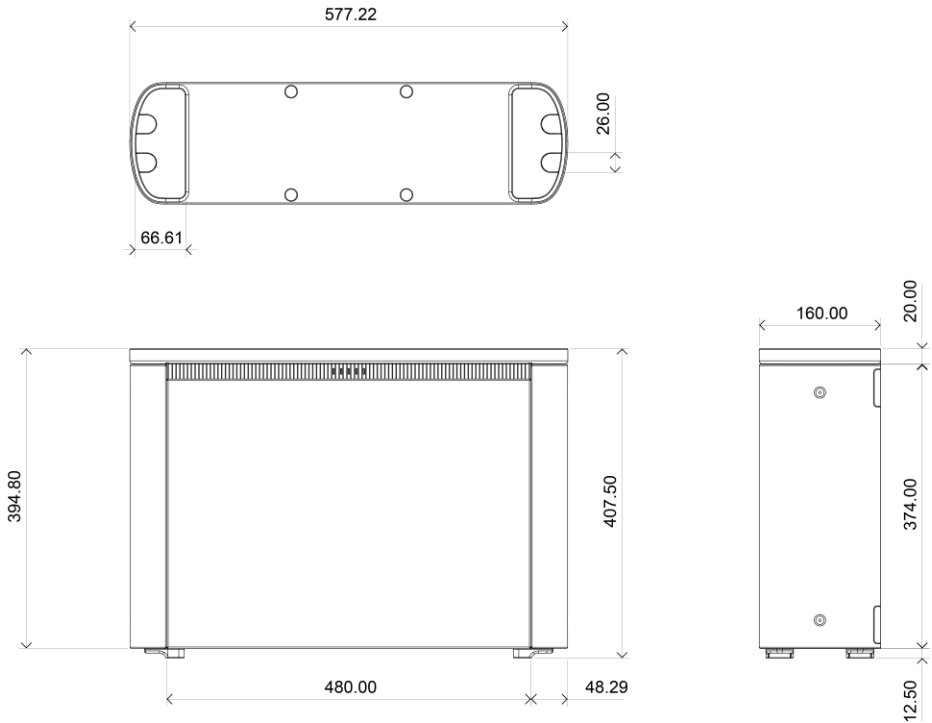

Basic Parameters	Pelio-L-5.12
Nominal Voltage (V)	51.2
Nominal Capacity (Wh)	5120
Usable Capacity (Wh)	4864
Depth of discharge (%)	95
Dimension (mm)	395*578*165
Weight (kG)	45
Discharge Voltage (V)	44.8 ~ 56.8
Charge Voltage (V)	56.0 ~ 56.8
Recommend Charge/Discharge Current (A)*	80
Max. Charge/Discharge Current (A)	100~120@15min
Peak Charge/Discharge Current (A)	120~200@15sec
Communication	RS485, CAN

Basic Parameters	Pelio-L-5.12
Connection	WI-FI (2.4G), USB 2.0
Configuration (max. amount per system)	20pcs
Working Temperature	0°C~50°C Charge
	-10°C~50°C Discharge
Shelf Temperature	0°C~40°C(6 months) -20°C~45°C(3 months)
Short current/duration time	<2000A/1ms
Cooling type	Natural
Protective class	I
IP rating of enclosure**	IP65
Humidity	5% ~ 95%(RH) No Condensation
Altitude(m)	≤4000
Design life	15+ Years (25 °C /77 °F)
Cycle Life	>6,000@25 °C
Reference to standards	IEC62619, IEC63056, IEC62040, IEC62477-1, UL1973,U1642,UL9540A, VDE2510- 50, IEC61000-6-2, IEC61000-6-3, UN38.3

*: Derating depends on voltage, SOC and temperature

** : IP rating base on product finish installation properly follow this manual.

2.3 Equipment interface instruction

Operation window: **If not using, must close and lock the cover.**

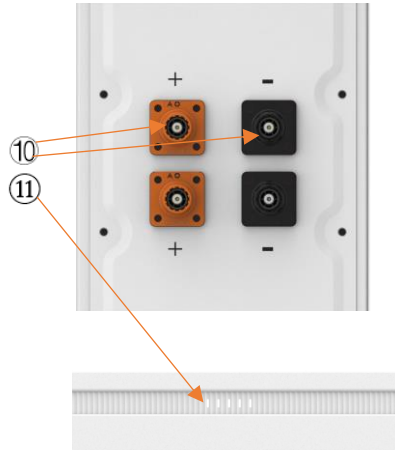
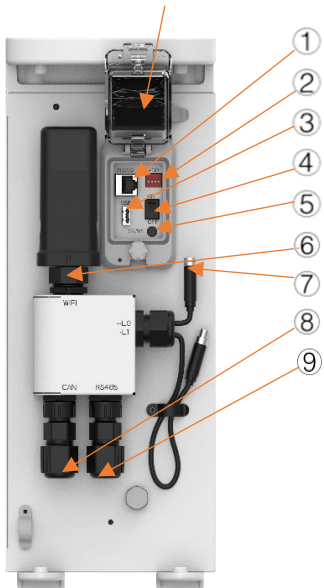

1) Console Port

For manufacturer or professional engineer to debug or service.

Pin3	232-TX
Pin6	232-RX
Pin8	232-GND

2) ADD Switch

Dip1: RS485 baud rate, after change, please restart battery.

0	1
115200	9600

Dip2~4: Reserved

3) USB Port

For manufacturer or professional engineer to debug or service. USB2.0.

4) Power Switch

ON: ready to turn on.

OFF: power off. For storage or shipping.

5) Start Switch

Turn on: press more than 3s to start the battery module.

Turn off: press more than 3s to turn off the battery.

6) WIFI Port

Connect the WIFI block from Pylontech ONLY.

DO NOT connect any other USB device.

7) Link Port 0, 1

For communication between multiple parallel batteries.

8) CAN

500 Kbps. For connection to inverter

9) RS485

9600 or 115200 bps. For connection to inverter

	CAN	RS485
Pin1~3	NA	NA
Pin4	CAN-H	
Pin5	CAH-L	
Pin6	GND	
Pin7		485A
Pin8		485B

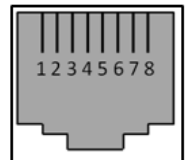

RJ45 Port



RJ45 Plug

10) Power Terminals

Power cable terminals: two pair of terminals with same function.

Power cables uses water-proofed connectors. must keep pressing the Lock Button on left and right sides while pulling out the power plug.



Warning

All the terminals/ports must be correctly locked after installation.

11) LED Status Indicators

LED status and icons	Off	On	Flash, 1s/1s	Flash, 0.5s/1.5s	Flash, 0.5s/0.5s
White					
Orange					
Frequency (2S / cycle)					

Definition	L1	L2	L3	L4	L5	Note
Power off						
Turn on						Until finish
Normal status: Idle						SOC: 100~76
						SOC: 75~51
						SOC: 50~26
						SOC: 25~0
Normal status: Charge						SOC: 100~76
						SOC: 75~51
						SOC: 50~26
						SOC: 25~0
Normal status: Discharge						SOC: 100~76
						SOC: 75~51
						SOC: 50~26
						SOC: 25~0
Protection						Temperature

Definition	L1	L2	L3	L4	L5	Note
			●			Voltage, SOC
				●		Current
					●	HV lock
Error	◐	Show Normal status				Address fail, slave off line
	★	○	○	○	○	BMS error
		●				CMOS fail
			●		★	DMOS fail
				●		Reverse connection
USB: Logging	★	○	○	○	●	1: download data event
		○	○	●	●	2: download data history
		○	●	●	●	3: download data log
		●	●	●	●	4: done, 2s
Upgrade	★	○	○	○	●	1: receiving file
		○	○	●	●	2: sending to slave
		○	●	●	●	3: upgrading
		●	●	●	●	4: will restart soon

If upgrading or USB working, will not show other status.

BMS basic function



Protection and alarm	Management and monitor
Charge/Discharge End	Cells Balance
Charge Over Voltage	Intelligent Charge Model
Discharge Under Voltage	Charge/Discharge Current Limit
Charge/Discharge Over Current	Capacity Retention Calculate
High/Low Temperature(cell/BMS)	Administrator Monitor
Short Circuit	Operation Record
Input over voltage	Power Cable Reverse
	Soft start of inverter

3. Safe handling of lithium batteries guide

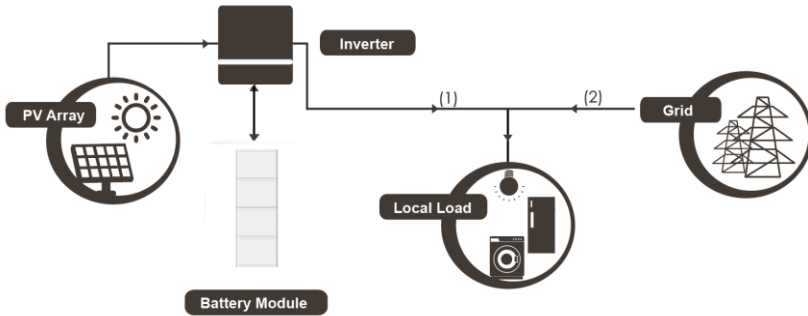
3.1 Schematic diagram of solution



3.2 Tools

 <p>Wire Cutter</p>	 <p>Crimping Modular Plier for RJ45</p>	 <p>Socket Wrench 14mm for M8 outer hexagon expansion bolt</p>
 <p>Screw Driver Set PH2</p>	 <p>Electric Screw Driver PH2</p>	 <p>Allen Key for DIN912 M5 hexagon socket screw</p>

3.3 Safety Gear

It is recommended to wear the following safety gear when dealing with the battery pack.



Insulated gloves



Safety goggles



Safety shoes

4. Installation and Operation

4.1 Package List

1) For battery module package:

Item	Description	Set
1	Battery module	1
2	Side cover	2
3	Negative cable for parallel connection, 4AWG, 0.36m	1
4	Positive cable for parallel connection, 4AWG, 0.36m	1
5	Outer hexagon screw M6×16 for grounding cable	1
6	Hexagon socket screw DIN 912 M5×20 for stack installation	4
7	Warranty card	1
8	User manual	1
9	Waterproof locker for L0, 1pcs on terminal, 1pcs spare part	1
10	Waterproof locker for L1, 1pcs on terminal, 1pcs spare part	2

2) Two kinds of installation kits

KIT W(Wall-mounting) and KIT G(Ground installation)

TO BE PURCHASED SEPARATELY, please base on the installation environment to select the proper kits.

Mandatory to purchase either of the kit to complete the installation.

KIT W is for max. 3 modules` wall-mounting installation.

KIT G is for max. 4 modules` ground-mounting installation.

Item	Description	KIT W	KIT G
1	Positive power cable*1.2m, 4AWG	1	-
	Positive power cable*2.5m, 4AWG	-	1
2	Negative power cable*1.2m, 4AWG	1	-
	Negative power cable*2.5m, 4AWG	-	1
3	Communication cable*2.5m, RJ45	2	2
4	LINK cable between two stacks, 1.5m	1	1
5	Grounding cable*2.0m, 6AWG	1	1
6	Communication connector for RJ45	2	2
7	Base	1	1
8	Wall connection bracket, 98.5*45*40mm	2	2
9	Hexagon socket screw M5×10 for [8] and module	2	2
10	Cable bundle bracket, 49mm×12mm×11.5mm	2	2
11	Cross screw M4*6 for [10] and enclosure	4	4
12	Expansion bolt M8x60 for [7][8][16][17] to wall/ground	8	4
13	Power terminal water proof locker	4	4
14	Packing list	1	1
15	Pan-head cross screw M6*16 for [7][16][17] connect	4	-
16	Right holder	1	-
17	Left holder	1	-
18	Plastic top cover	2	2
19	Plastic cross screw for [18], 1 pcs spare part	5	5
20	Power terminal protection cover, water proofed	4	4
21	WIFI block	1	1

3) KIT Cable

(TO BE PURCHASED SEPARATELY, for power expansion purpose only , not mandatory to purchase if the KIT W or KIT G is sufficient for power demand)

Item	Description	Set
1	Negative power cable*1.2m, 4AWG	1
2	Positive power cable*1.2m, 4AWG	1

4) Kit WiFi

(TO BE PURCHASED SEPARATELY, for system monitoring purpose only, not mandatory to purchase if using the Wi-Fi block from KIT W or KIT G)

Item	Description	Set
1	WiFi block	1
2	Manual	1
3	Warranty card	1
		

4.2 System Working Environments Checking

4.2.1 Cleaning



Reminding

Keep environment clean

Before installation please make sure the dust and iron scurf must be removed to keep a clean environment. The system cannot be installed in desert area without an enclosure to prevent from sand.

4.2.2 Ventilation



Reminding

Keep environment suitable

There are no mandatory ventilation requirements for battery module, but please avoid of installation in confined area. The aeration shall avoid of high salinity, humidity or temperature.



Reminding

Please avoid frost or direct sunlight.

Out of the working temperature range will cause the battery system high / low temperature alarm or protection which further lead to the cycle life reduction.

According to the environment, an air-conditioning system could be installed when necessary.

4.2.3 Grounding System



Caution

Make sure the grounding point of the basement is stable and reliable.

The resistance of the grounding system must $\leq 100\text{m}\Omega$

4.2.4 Clearance

Keep away from any heat source for more than 2 meters.

Minimum clearance to battery module(rack) shall more than 0.4 meters.

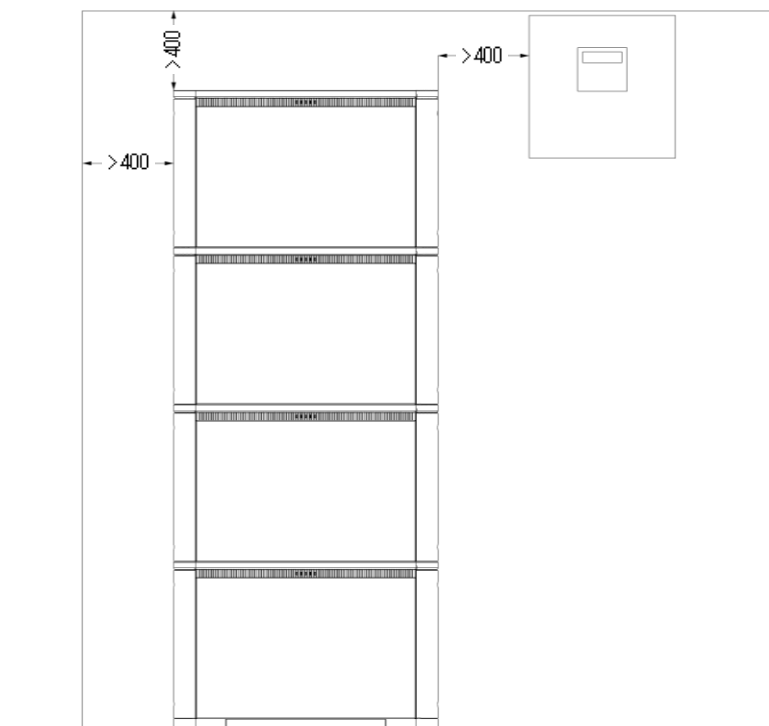

4.3 Preparation Before Installation



Warning

The battery system has potential threat so it must be installed in area away from children or pet.

The battery system can be operated by qualified and authorized person only.

4.3.1 Operating Precautions



Reminding

Weight >40kg

Single battery module is about 45kg so it must be operated by more than 2 personnel when don't have any handing tools.

4.3.2 Plan the Installation Site

1) Choose a solid wall or a flat ground capable of supporting the total weight of

battery system, this also depends on the Installation method selected.

- 2) Make sure the area is isolated from hazards that could damage battery.
- 3) Make sure the ambient temperature is within 0 ~ 50°C for operation.
- 4) The installation areas shall avoid of frost and direct sunlight.

4.3.3 Unboxing the Package

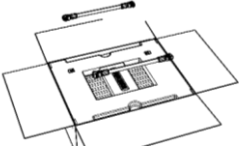
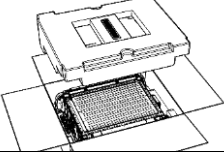
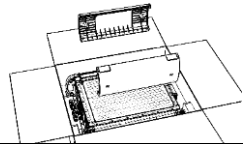
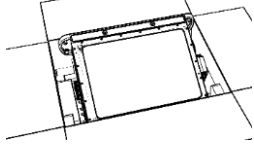
Open carton box, take out the two power cables	
Remove the foam board on the battery module.	
Take out the two shields.	
Take out the battery module. The battery module is about 45kG, please operate with caution.	

4.4 Installation

4.4.1 Wall Mounting

- 1) Plan the layout in advance and choose the appropriate position to anchor the brackets onto the wall.



Reminding

Choose suitable wall

Choose a wall capable of supporting the total weight of battery system (**max. 150kg**, which is three battery modules per row) and thick enough to fix in the expansion bolt properly, with one of the following characteristics:

- Wood studs at regular intervals

- Plywood sheeting of sufficient thickness
- Solid concrete or masonry
- Metal studs of sufficient gauge

2) Turn the base upside down. Install the two holders on the base.



3) Fix the holder on the wall. **Please ensure the horizontal of the base. A level may needed.**

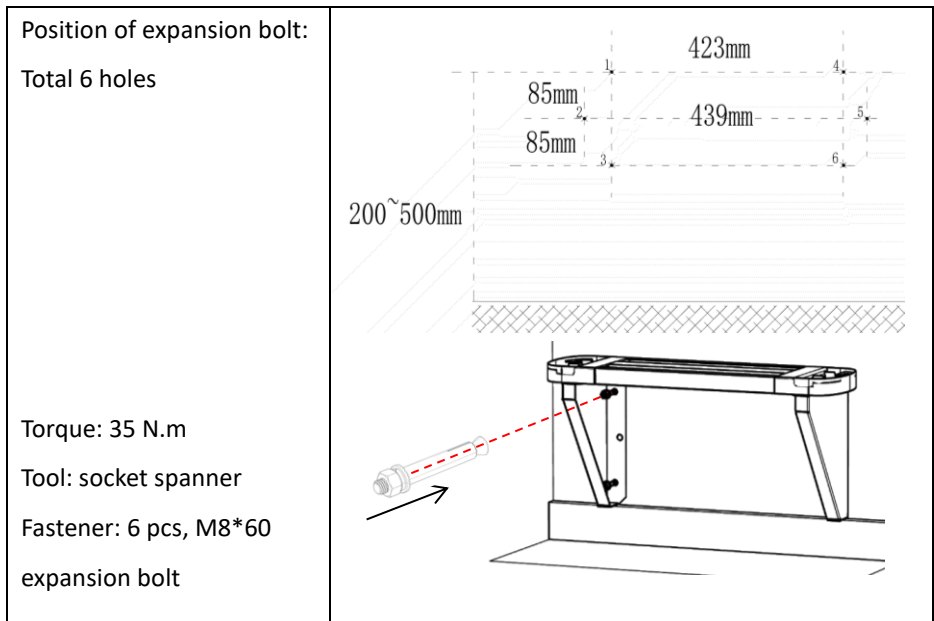

4.4.2 Ground Mounting

1) Plan the location in advance and choose a level surface. Make sure the area is isolated from hazards that could damage battery system, such as heating source, flammable material or flooding. Consider the spacing requirements for battery system.



Reminding

Choose suitable ground

Choose the ground capable of supporting the full weight of battery system (**max. 200kg**, which is four battery modules per stack) and able to fix in the expansion bolt properly.

2) Fix the base on the ground.

<p>Position of expansion bolt.</p> <p>Away from wall: 110mm</p> <p>Space between: 504.5mm</p> <p>Torque: 35 N.m</p> <p>Tool: socket spanner</p> <p>Fastener: 2 pcs, M8*60 expansion bolt</p>	
--	--

4.4.3 Battery installation

1) Place the battery module on the base and fix the foot with 4 screws.

<p>Torque: 3 N.m</p> <p>Tool: hexagon socket,</p> <p>Fastener: 4 pcs, M5*20</p>	
---	--

2) For multiple battery installation, lift the next battery module and put it on the top of previous battery module. And fix the foot with 4 screws.

3) Before install the last battery. Using the foam of battery module packaging to get the position of expansion bolt for wall mounting bracket.

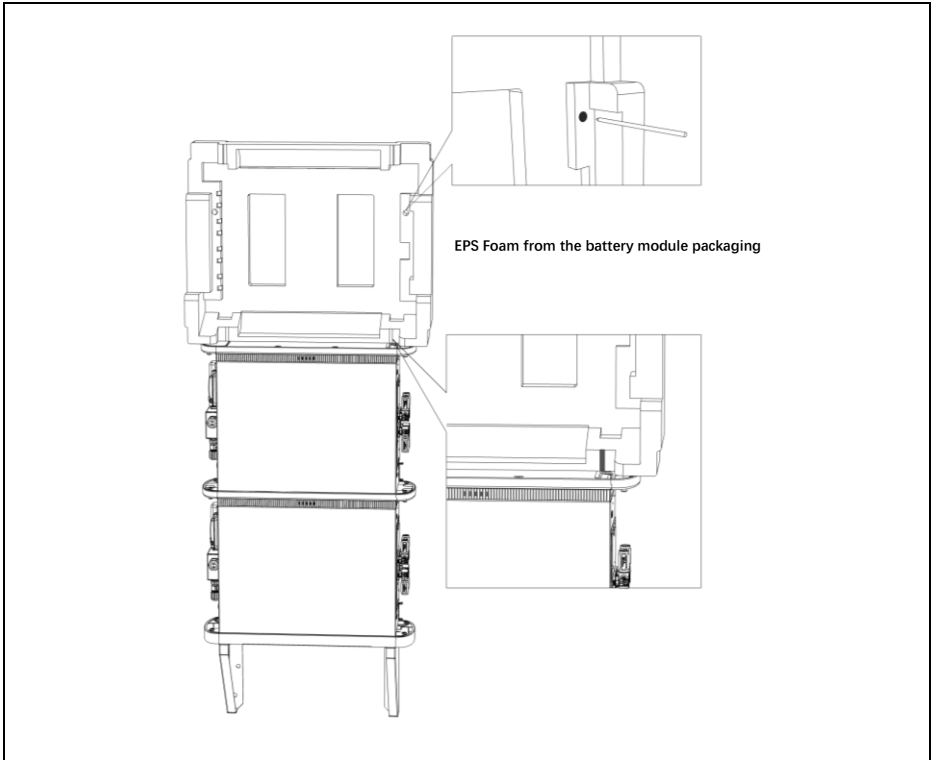

- 4) Install the last battery on top, connect one side of the wall mounting bracket on the battery enclosure and the other side to the wall. Use expansion bolt to fasten the bracket on the wall. Then, install the bracket on the battery case with screws.

<p>1. Wall:</p> <p>Torque: 35 N.m</p> <p>Tool: socket spanner</p> <p>Fastener: 2 pcs, M8*60</p> <p>2. Enclosure:</p> <p>Torque: 3 N.m</p> <p>Tool: hexagon socket</p> <p>Fastener: 2 pcs, M5*10</p>	<p>The diagram illustrates the installation of two wall mounting brackets. On the left, a callout box shows two steps: 1. A bracket is mounted to a wall using an expansion bolt. 2. The bracket is then mounted to the enclosure using a screw. On the right, a perspective view of the enclosure shows the two brackets (labeled 1 and 2) being installed. Red boxes highlight the mounting points on the enclosure, and an arrow points from the callout box to these points.</p>
---	--

5) Maximum number in stack.

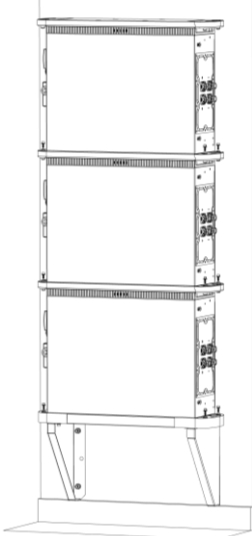
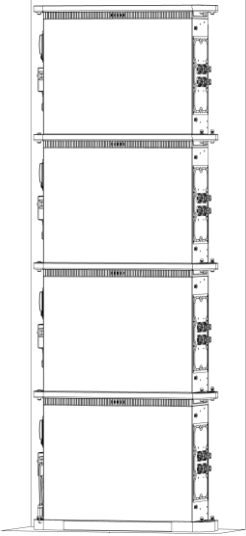
3-modules stack for wall mounting.	4-modules stack for wall mounting.
	

4.5 Power cable connection



Danger

DO NOT reverse connect the power terminal

DO NOT short connect the power cable

DO NOT connect batteries in series

- 1) Black color cable for negative, orange color cable for positive.
- 2) After heard “click” sound means the connector is correctly connected.

<p>3) Keep pressing the clamp on both sides of power terminal when pulling out the terminal.</p>	
--	---

<p>4) Connect the power cables between battery modules, Keep the power cables inside the handle of battery module.</p>	
--	--

<p>5) Connect the power cable to inverter: Go through the wall mounting bracket or cable bundle bracket Or Go through the top cover</p>	
---	---



Reminding

Ensure IP rating of system

<p>6) Always remember to lock all the power terminal not used. The lockers are inside KIT W and KIT G.</p>	
--	--

7) For power cable deployment, please refer to [4.13]

4.6 Communication cable connection



Reminding

Wrong cable connection may cause the battery system failure.

4.6.1 LINK cable

1) Master and slave

For 1 battery system, left L1 and L0 EMPTY.

For more than 1 battery system, connect first battery L1 to next battery L0.

L0 EMPTY	Master battery (module 1)
L0 and L1 connected	Slave battery
L1 EMPTY	Last slave battery

2) Connection

<p>Cross the cable inside the handles. And using bundles on enclosure to fix the cable.</p>		
Link 1		
Link 0		
Connection	<p>Arrow to Arrow, only 1 position can connect in</p>	
Locking	<p>Rotate on both sides</p>	
Locked		<p>Rotate until end</p>



Reminding

Must sealing the terminal not used

- 3) Always remember to lock the terminal not used. The waterproofed locker is connected on the LINK terminal at the beginning.

4.6.2 CAN and RS485 cable

- 1) Using the RJ45 cable from KIT W, KIT G, or outdoor network cable (CAT5E or higher standard).







The RJ45 terminal of cable shall not have the sealing part.



Caution

Length of cable shall ≤ 3 meters

- 2) Follow below process to fit the water-proof connector on to the RJ45 cable.
(The cable color blue in below picture is just for reference.)

Get ready	 <p>Cross in the locker[1] first and then the sealing rubber[2][3]</p>
Put in	 <p>Put the RJ45 into the connector and then put in the sealing rubbers</p>
Finish on cable side	 <p> Rotate the locker[1] until the end</p>
Connect to socket	 <p> Then connect to CAN or RJ45 socket and then rotate nut[4] to the end</p>

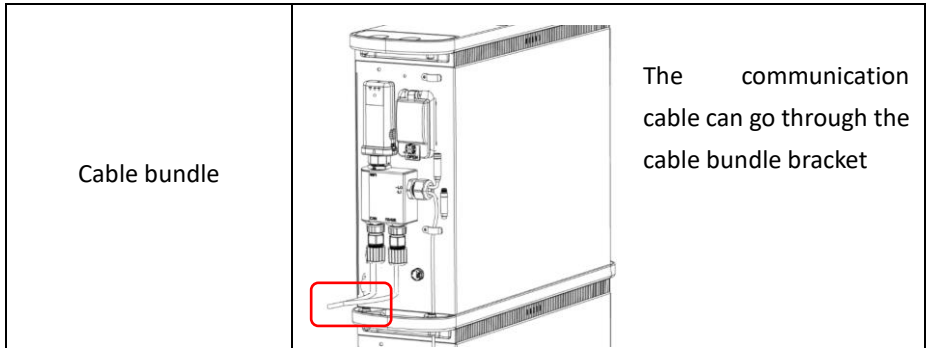

4.7 Ground cable connection

Grounding cables shall be 6AWG or higher yellow-green cables. After connection, the resistance from battery grounding point to ground connection point shall smaller than 0.1Ω.

Each battery enclosure has 2 grounding point on power cable side, either one can be used.

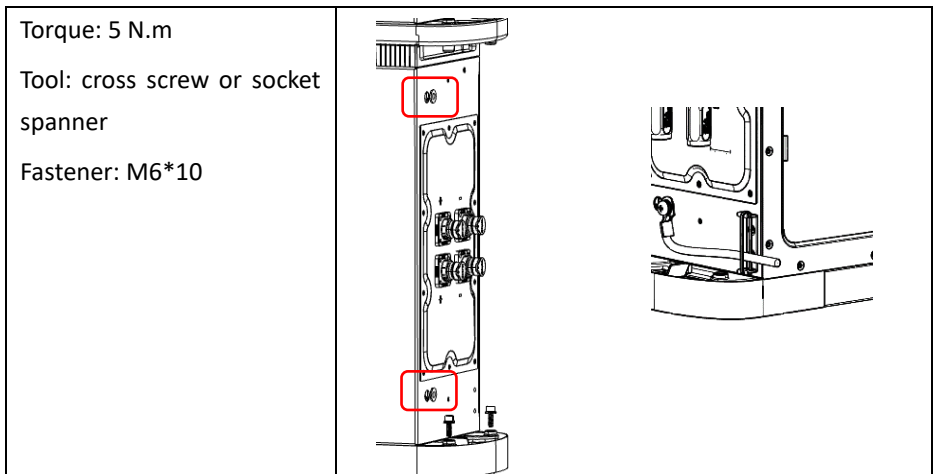

For battery in stack, the grounding connection was ensured by 4 screws in between [4.3.3].

Each stack of battery needs one pair of grounding cable.

4.8 Plastic covers

After all the installation and debug finished on site, the plastic covers can be installed.

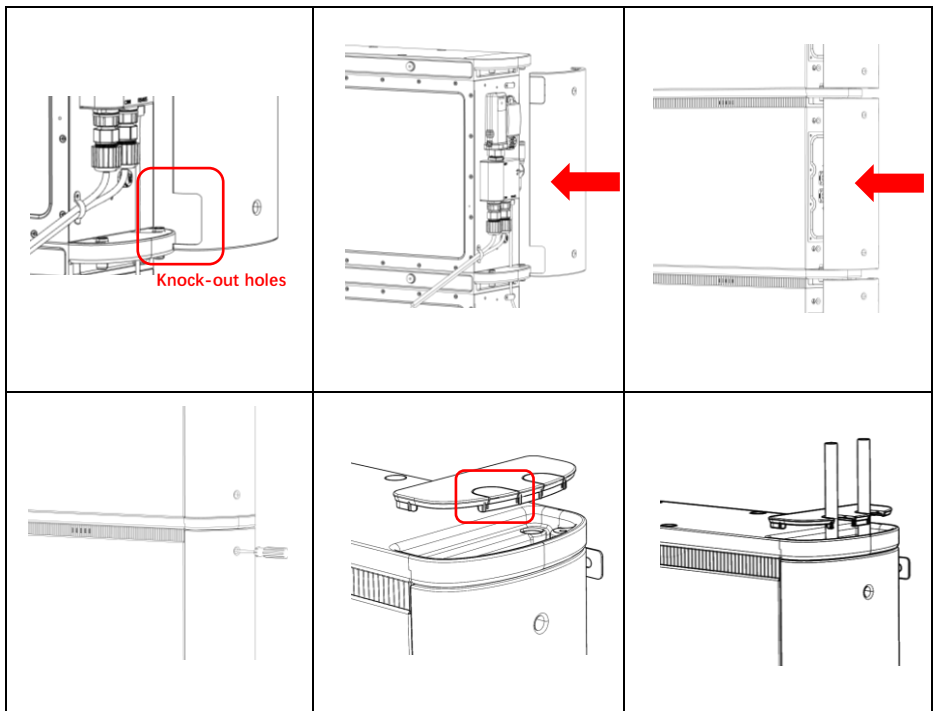

- 1) Knock out if there is cable going through.
- 2) Simply click in the cover on both sides.
- 3) Screw and fixed the cover with a cross screwdriver. (PH2 header)
- 4) For the top battery, knock out top cover if there is cable going through.
- 5) Screw and fixed the cover with a cross screwdriver and the plastic screw.



4.9 Power on

Double check all the power cable and communication cable between batteries and between battery and inverter. Switch ON the circuit breaker between battery and inverter if available.

1) Operation

<p>Switch ON</p>		<p>Switch on the power switch of all the batteries</p>
<p>Press Start Or Active by DCBUS voltage</p>		<p>Press Start button of first battery for more than 3 seconds. Or Provide a DC voltage (>48Vdc) on power terminal.</p>
<p>LED on</p>		<p>The LED of the first battery will lighting and then ALL the batteries LED will lighting.</p>



Reminding

Must close and lock the cover after operation

2) Information for reference

<p>Soft start</p>	<p>If no fault exist, battery will start pre-charging process. Maximum 3 seconds and then close main MOSFET.</p>
<p>Time</p>	<p>If 20 batteries in parallel connection, it takes maximum</p>



	35 seconds for master battery to get system ready (ensure all batteries online and external communication working properly) The system still able to output power during this 35 seconds.
Expansion	During capacity expansion or replacement, when parallel different SOC/voltage of module together, it is recommended to maintain the system in idle for ≥ 15 mins or till the SOC LEDs becomes similar (≤ 1 dot difference) before normal operation.

4.10 Power off

Turn external power source off.

Turn OFF the switch or relay between battery and inverter if available.

1) Operation

Press Start	 <p>Press START button of master battery module for more than 3 seconds until all LED on master battery lighting, then release.</p>
LED out	All the batteries LED will be out and stop showing any status.
Switch OFF	 <p>Switch power switch of every battery to OFF position.</p>



Reminding

Must close and lock the cover after operation

2) information for reference

Auto power OFF	If master battery or the last battery meet the conditions of power off, then all the battery will be OFF.
Time	If power OFF operation success, the LED turns off then the MOSFET of battery will open. But battery BMS may still working backstage for few seconds to dealing with info storage and power off self-check.

4.11 USB interface

The USB flash disk is not in package of Pelio. USB 2.0 or higher can be used.

	<p>1) Log Export Mode</p> <p>The battery shall be turned ON first, then insert the USB flash disk and wait for LED shows finish.[2.3-11]). then Pull out the disk.</p> <p>The log file will be saved automatically in USB.</p> <p>The log file of each battery need to be export one by one.</p>
	<p>2) Upgrade Mode</p> <p>Contact with Pylontech or authorized engineer for the latest firmware.</p> <p>Save the correct firmware inside the USB flash disk folder: pylon/bin/</p> <p>The battery shall be turned ON first, then insert the USB flash disk on master battery and wait for LED shows finish.[2.3-11]). Then Pull out the USB flash disk.</p> <p>The master battery will upgrade all the slave batteries.</p> <p>All the battery will restart to finish the upgrade.</p> <p>If firmware inside USB flash disk, will do upgrade function only.</p>



Reminding

Pull out the USB flash disk in time after operation success
Must close and lock the cover after operation

4.12 Wi-Fi interface

The Wi-Fi module is not in the package of battery module. It's within the KIT W, KIT G and KIT WIFI which are purchased separately.

Only the master battery needs to connect the Wi-Fi module (control maximum 20 batteries).

The WiFi block need to connect to local 2.4G WiFi net and need an APP for operation. For detailed information please refer to user manual of WiFi block.

Function:

7*24H monitor of your battery system

Register and after sale service from Pylontech

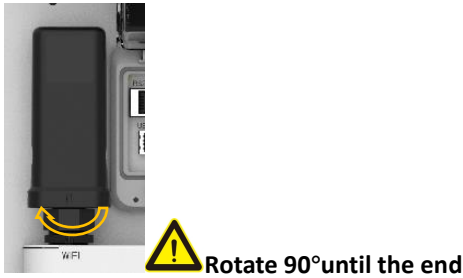
Put in	The LED towards outside
Lock	
Working	The WiFi block will automatic turns on after battery turns on. And then just need to operate on APP.

For further guidance of Wi-Fi module operation, please read the separate Wi-Fi module manual.

4.13 Power connection planning

Each stack maximum 4 batteries and maximum 5 stacks. For multi batteries connection, the suitable bus bar and DC breaker is required.

Please take follows into consideration:



1)  The cable, 1 sets of power cable hold maximum 100A current.







2) The maximum power of inverter or DC loads.

3) The parameter of breaker. The maximum short circuit current for calculation of each module is 2000A.

	Icu of breaker
1~4 modules	$\geq 10\text{kA}$
5~8 modules	$\geq 20\text{kA}$





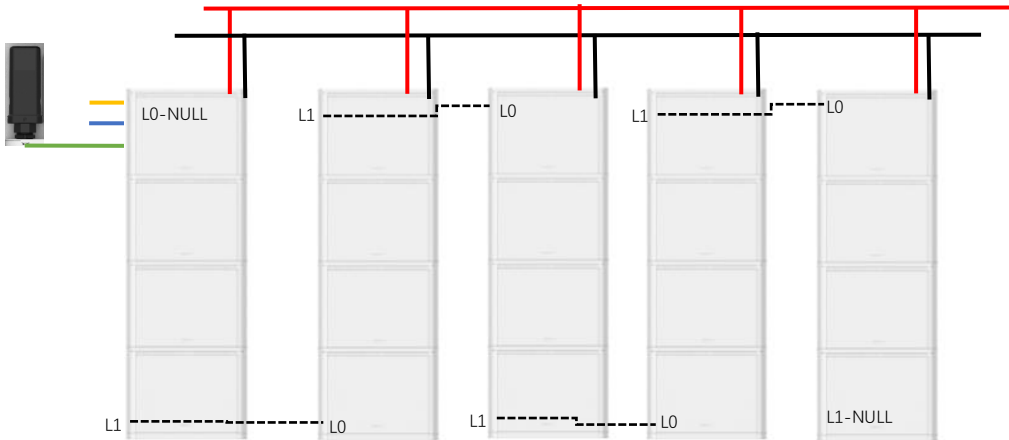

4) The connection diagram of each stack and how much power supported

Battery	KIT W	KIT G	1 set of cable	2 sets of cable	3 sets of cable	4 sets of cable
1	√	√				
Max power			80A/4kW			
2	√	√				
Max power			100A/5kW	160A/8kW		

3	√	√				
Max power			100A/5kW	200A/10kW	240A/12kW	
4	-	√				
Max power			100A/5kW	200A/10kW	300A/15kW	320A/16kW

4.14 Multi stack connection



	WiFi connection		Positive cable
	CAN cable		Negative cable
	RS485 cable		L0-L1 cable

- 1) Only master battery connect the RS485 or CAN to inverter and the WiFi stick.
- 2) Always connect L1 to next battery L0 one by one until the last battery.
- 3) A suitable DC bus bar and breaker between battery system and inverter is required.

5 Trouble shooting

- Communication related problem

Appearance: Unable to communicate with inverter on compatible list.

Solution:

- 1) RS485: Check the dip switch [2.3], set to correct baud-rate and restart.
- 2) CAN: Check CAN-H, L, GND pin orders. [2.3]

- Functional related problem

Appearance: Strange LED

LED						BMS LED control error
-----	--	--	--	--	--	-----------------------

Solution: Refresh the firmware[4.11-2)] or ask your local distributor for help.

Appearance: LED follow below either combination

Protection						Temperature
						Voltage, SOC
						Current
						HV lock
Error			Show Normal status			Slave offline
						BMS error
						CMOS fail
						DMOS fail
						Reverse connection

1) Temperature

a) Above 60°C or under -10°C, the battery could not work.

Solution:

- Move battery to the normal operating temperature range between 0°C and

50°C.

- Ensure the operation current is no more than 90Amps for long time, and the battery enclosure shall avoid direct sunlight.

If problem remains after above troubleshooting steps, please extract the logs from the battery using the USB, switch off the module and send the logs to your local distributor for help.

2) Voltage, SOC

- a) Low Voltage: When the battery discharges to 45V or less, battery protection will turn on.

Solution: Charge the battery till the red light turns off.

- b) Cell voltage high. The module voltage is lower than 56V, SOC LED does not all on. The module protection disappears when discharge.

Solution: keep charge the module by 55-56V or keep the system cycle. The BMS can balance the cell during cycling.

- c) High Voltage: If charging voltage above 57V, battery protection will turn on.

Solution: Check whether voltage is too high or not, if it is, to change the settings on power supply side. And discharge the module.

If problem remains after above troubleshooting steps, please extract the logs from the battery using the USB, switch off the module and send the logs to your local distributor for help.

3) Current

- a) If current exceeds 90A for long time, battery protection will turn on.

Solution: Check whether current is too large or not, if it is, change the settings on inverter side.

If problem remains after above troubleshooting steps, please extract the logs from the battery using the USB, switch off the module and send the logs to your local distributor for help.

4) HV lock

- a) Cell voltage higher than 4V or module voltage higher than 59.2V.

Solution: Battery system requires properly established communication with

inverter and correctly settings on inverter to run safely. Check the setting of the inverter or charger, the charge voltage shall be 56-56.8Vdc; Check the communication between battery system and inverter whether established or not; Check the ADD switch on battery module whether is set correctly or not; Under this condition, the BMS remains functional without damage. Just leave the module switched OFF and wait for the battery voltage drop down naturally(15mins) then restart. If then no alarm comes out, this means the module is ready for work again.

If problem remains after above troubleshooting steps, please extract the logs from the battery using the USB, switch off the module and send the logs to your local distributor for help.

5) Slave offline

a) Slave module over discharged.

Solution: Recharge the battery system into relevant SOC range.

b) Communication cable loosen between battery modules.

Solution: Double check the connectivity of the communication between the battery modules. Make sure there is no loosen or damage.

If the slave batteries are operating normally, and the communication cable is checked, but the slave offline error remains, please extract the logs from the battery using the USB, switch off the module and send the logs to your local distributor for help.

6) BMS error

Solution : Extract the logs from the battery using the USB, switch off the module and send the logs to your local distributor for help.

7) CMOS fail

a) The fuse blew out.

Solution: Power off all battery and inverters. Disconnect breaker. Check the cable connection and disconnect all power cables. Check the power port damaged or not. Check the setting of inverter or charger, check the communication between

inverter and battery system.

Try turn on the single module, without any cable connected. If the error remains, extract the logs from the battery using the USB, switch off the module and send the logs to your local distributor for help.

8) DMOS fail

b) The fuse blew out.

Solution: Power off all battery and inverters. Disconnect breaker. Check the cable connection and disconnect all power cables. Check the power port damaged or not. Check the setting of inverter or charger, check the communication between inverter and battery system.

Try turn on the single module, without any cable connected. If the error remains, extract the logs from the battery using the USB, switch off the module and send the logs to your local distributor for help.

9) Reverse connection

a) Reverse connection of cables.

Solution: Power off all battery and inverters. Disconnect breaker. Check the cable connection and disconnect all power cables. Check the power port damaged or not. Then try turn on the single module, without any cable connected. If no alarm, then it is reverse connection of cables. Correct the wiring connection and reconnect the battery into the system properly.

If do see alarm without any cable connect to the module, extract the logs from the battery using the USB, switch off the module and send the logs to your local distributor for help.

● Battery cannot turn on, switch ON and press the SW, the lights are all no lighting or flashing.

1) Capacity too low, or module over discharged.

Solution: use a charger or inverter to provide 48-56.8V voltage. If battery can start, then keep charge the module and use USB extract the battery operation logs to check.

If battery terminal voltage is $\leq 45\text{Vdc}$, please use $\leq 0.05\text{C}$ to slowly charge the module to avoid affect to SOH.

If battery terminal voltage is $> 45\text{Vdc}$, it can use $\leq 0.8\text{C}$ to charge.

If battery cannot start by the charger or inverter, contact your local distributor for help.

Excluding the points above, if the faulty still cannot be identified, turn off battery and contact your local distributor.

- Emergency Situations

- 1) Leaking Batteries

If the battery pack leaks electrolyte, avoid contact with the leaking liquid or gas. If one is exposed to the leaked substance, immediately perform the actions described below.

- a) Inhalation: Evacuate the contaminated area and seek medical attention.
- b) Contact with eyes: Rinse eyes with flowing water for 15 minutes and seek medical attention as soon as possible.
- c) Contact with skin: Wash the affected area thoroughly with soap and water and seek medical attention.

Ingestion: Induce vomiting and seek medical attention.

- 2) Fire

If detect the battery cell is catching fire, firstly cut off the external power source. Then use vast of water for suppression. After fire suppressed, soaking battery within water and contact Pylontech or an authorized dealer.

If detect the cabling or other components (not battery cell) is catching fire. Firstly, cut off the external power source. Then use dry powder fire or carbon dioxide extinguisher for suppression.

- 3) Wet Batteries

If the battery module connector is wet or battery module submerged in water, do not let people access it, and then contact Pylontech or an authorized dealer for technical support. Cut off all power switch on inverter side.

- 4) Damaged Batteries

Damaged batteries are dangerous and must be handled with the utmost care. They are not fit for use and may pose a danger to people or property. If the battery pack seems to be damaged, pack it in its original container, and then return it to Pylontech or an authorized dealer.



Caution

Damaged batteries may leak electrolyte or produce flammable gas.

6 Remarks

Recycle and disposal

In case a battery (normal condition or damaged) needs disposal or needs recycling, it shall follow the local recycling regulation (i.e. Regulation (EC) N^o 1013/2006 among European Union) to process, and using the best available techniques to achieve a relevant recycling efficiency.

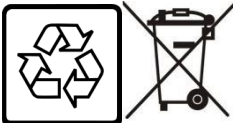

Li-ion ████████

Storage, Maintenance and Expansion

- 1) It is required to charge the battery at least once every 6 months, for this charge maintenance make sure the SOC is charged to higher than 90%. If you want to keep storing the battery for long term, it is recommended to discharge to 50-70% again.
- 2) Every year after installation. The connection of power connector, grounding point, power cable and screw are suggested to be checked. Make sure there is no loose, no broken, no corrosion at connection point. Check the installation environment such as dust, water, insect etc. make sure it is suitable for IP65 battery system.
- 3) A new battery module can be adding onto an existing system at any time. Please make sure the new battery is acting as the master. The new module, due to a higher SOH may have a difference on SOC with existing system, but it will not affect the parallel connection system performance.



PYLONTECH

Pylon Technologies Co., Ltd.

No. 73, Lane 887, ZuChongzhi Road, Zhangjiang Hi-Tech Park Pudong
Shanghai 201203, China

T+86-21-51317699 | **F** +86-21-51317698

E service@pylontech.com.cn

W www.pylontech.com.cn