



Quick Installation Guide

X1-Fit 3.7KW-7.5KW

IV

Battery Connection

Battery connection diagram:

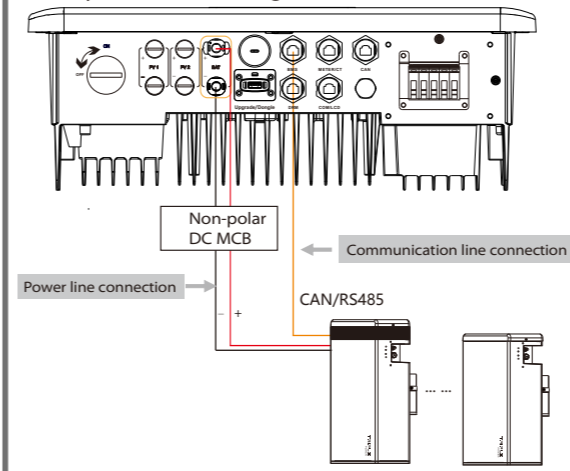

Note: When using Solax batteries, it is recommended that the number of battery control (T-BAT-5.8) is 1 and the number of battery modules (HV11550) is 0-2; the number of battery control (MC0600) is 1 and the number of battery modules (HV10230) is 1-4 pcs.

Battery port connection line of the X1-Fit G4 M version inverter is on the X1-Matebox, just connect it. It is necessary to wire the W version according to the following steps.

Step 1. Prepare 8-10 battery power line, find the DC plug (+), DC plug (-) in the accessory bag.

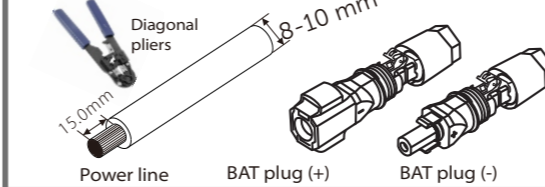

Step 2. Insert the striped cables into the DC plug (-) and DC Plug (+) respectively.

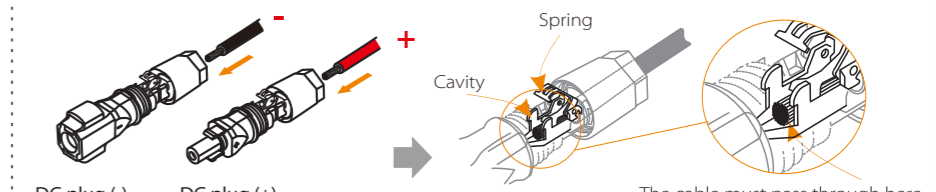

Step 3. Press down on the spring by hand, you can hear a click sound, then push the ends together, and tighten the screw joints.

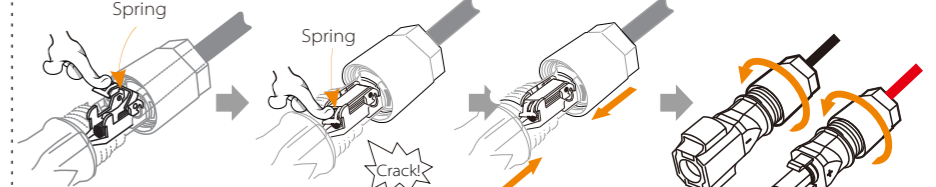

Step 4. Insert the battery power lines into the corresponding BAT port (+), (-) of the inverter.

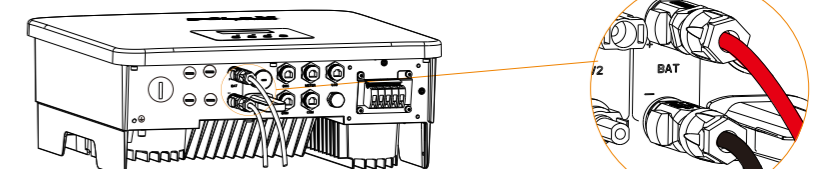

Note! After the BMS communication between the battery and the inverter is finished, the battery will work normally.

Note: BAT port, not PV port!
Note: The positive and negative wires of the battery are not allowed to be reversed!

I

Packing List

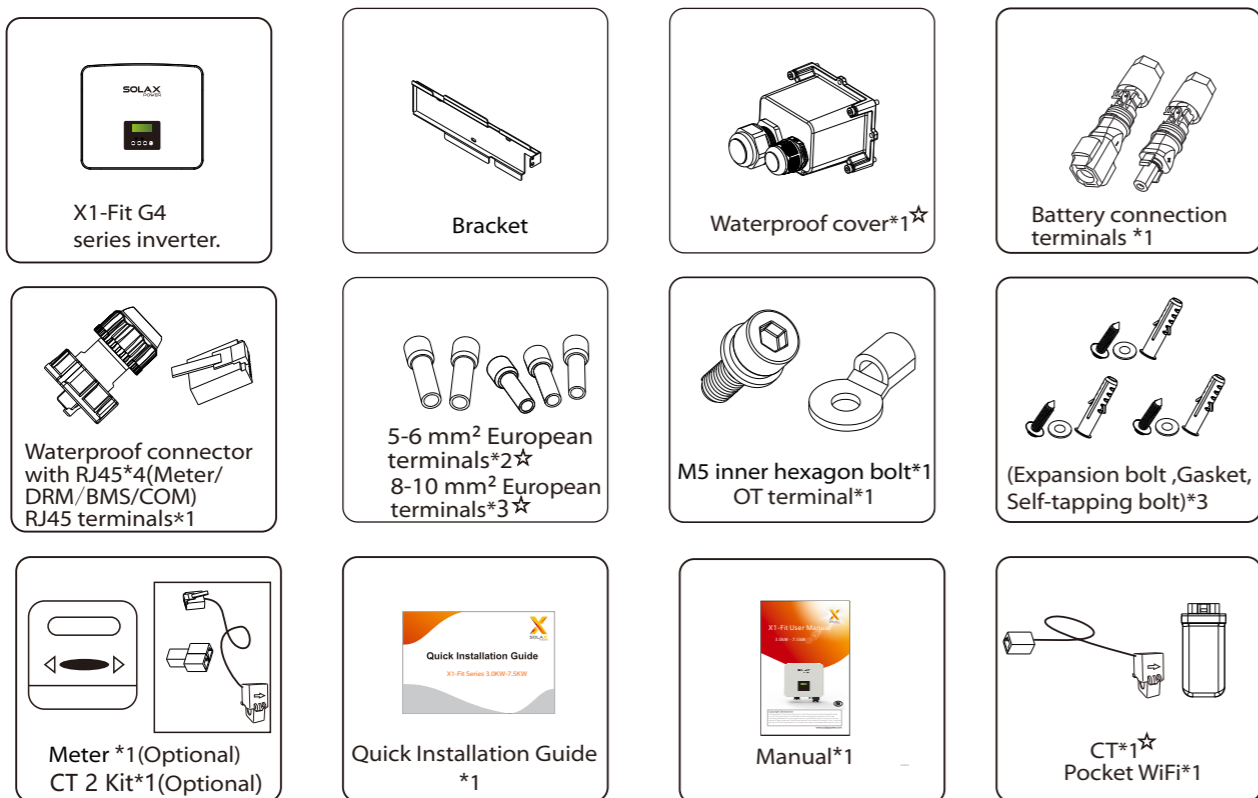

Note: Accessories with the mark * are not contained in the M-version inverter accessories package, but they are contained in the X1-Matebox.

V

Grid and EPS Connection

Diagram A: Neutral line and PE line are separated from each other, and the common load is connected to the EPS port; (For most countries)

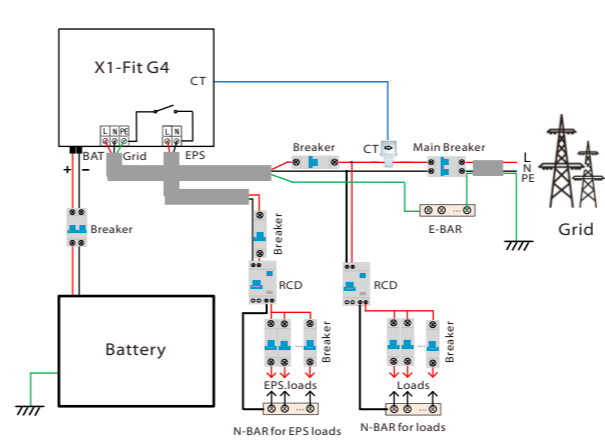

Diagram B: Neutral line and PE line are separated from each other, all loads connect to the EPS port; (For most countries)

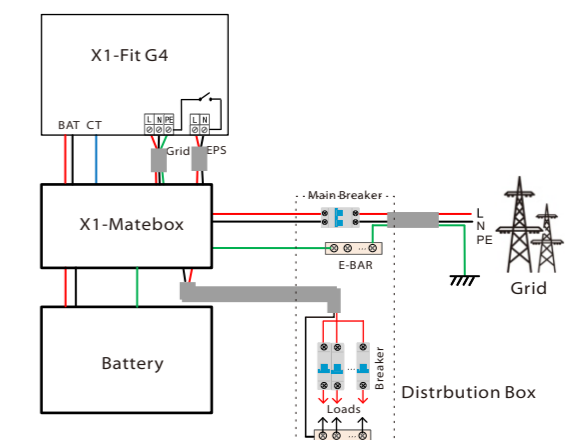

Diagram C: Neutral line and PE line are combined together, and the common load is connected to the EPS port; (Apply to Australia)

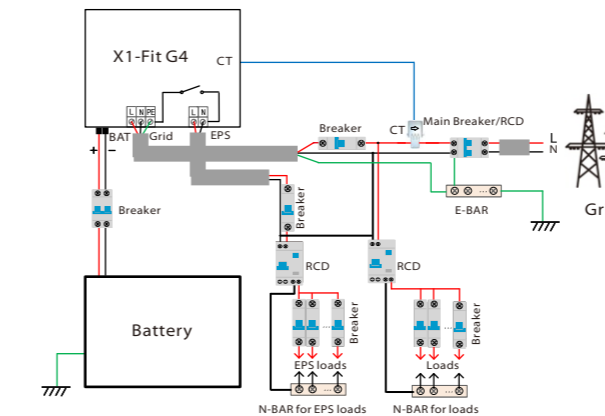
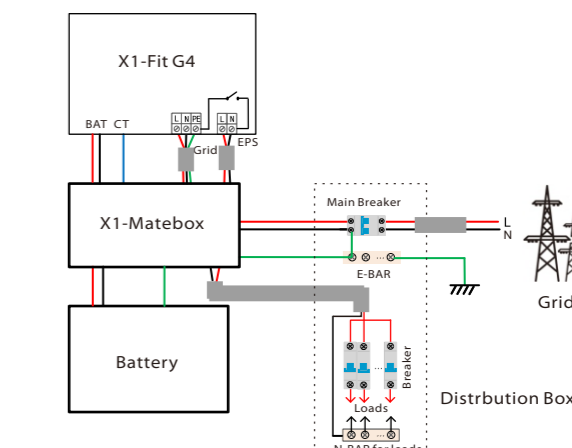

Diagram D: Neutral line and PE line are combined together, all loads connect to the EPS port; (Apply to Australia)



The Grid and EPS ports of X1-Fit G4 M version inverter have been connected, and the W version needs to be wired according to the following steps.

Step 1. Prepare a Grid cable (three-core wire) and an EPS cable (two-core wire), and then find the European terminal and waterproof cover in the accessory bag.



Model	X1-Fit-3.7-W	X1-Fit-5.0-W	X1-Fit-6.0-W	X1-Fit-7.5-W	Model	X1-Fit-3.7-M	X1-Fit-5.0-M	X1-Fit-6.0-M	X1-Fit-7.5-M
Cable (copper)	6-8mm ²	8-10mm ²	8-10mm ²	8-10mm ²	Cable (copper)	3-4mm ²	4-6mm ²	4-6mm ²	6-8mm ²
Micro-Breaker	40A	50A	50A	50A	Micro-Breaker	25A	32A	32A	40A

Model	X1-Fit-3.7-W X1-Fit-3.7-M	X1-Fit-5.0-W X1-Fit-5.0-M	X1-Fit-6.0-W X1-Fit-6.0-M	X1-Fit-7.5-W X1-Fit-7.5-M
Cable (copper)	3-4mm ²	4-6mm ²	4-6mm ²	6-8mm ²
Micro-Breaker	25A	32A	32A	40A

Step 2: The Grid and EPS cables go through the corresponding Grid and EPS ports of the waterproof cover. Remove the 12mm insulation layer at the end of the wire. Insert the European-style terminals respectively, and make sure that the stripped ends are inserted into the European-style terminal, and finally use crimping pliers to press tightly.

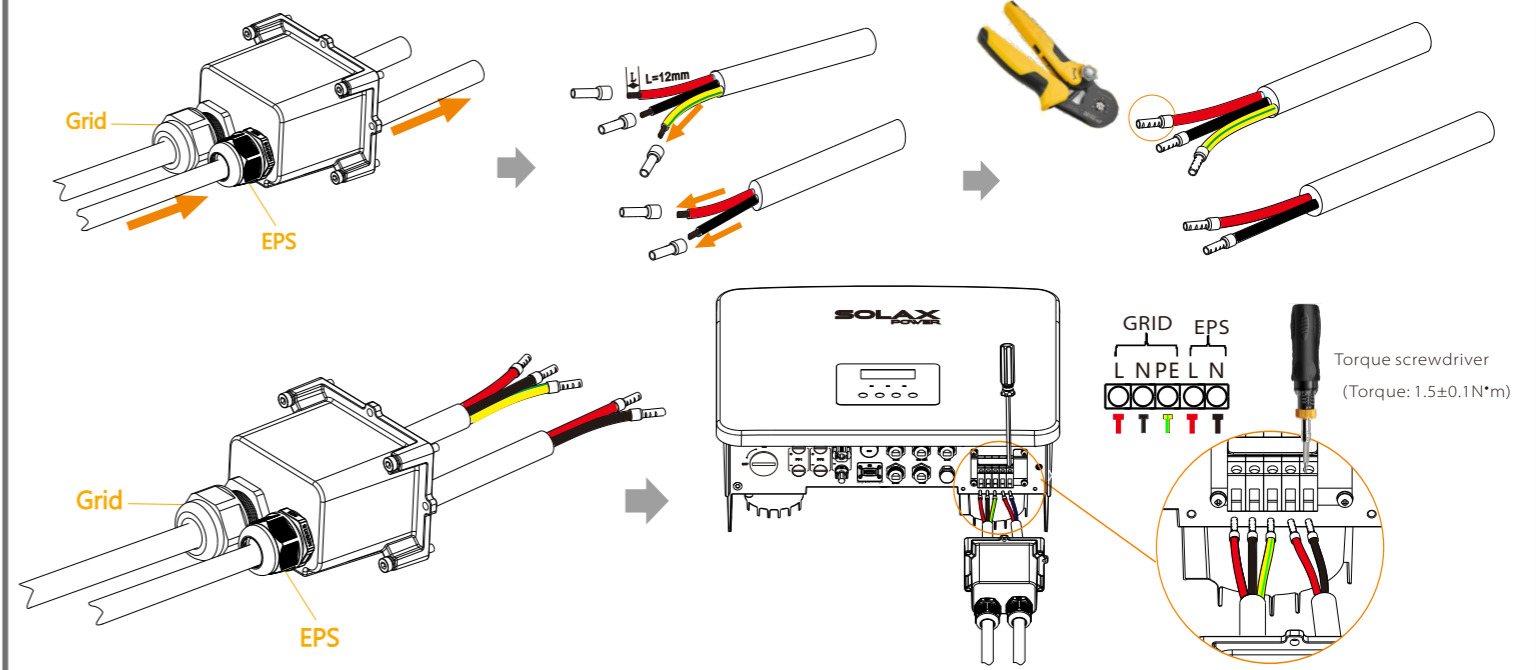

II

Tool Preparation

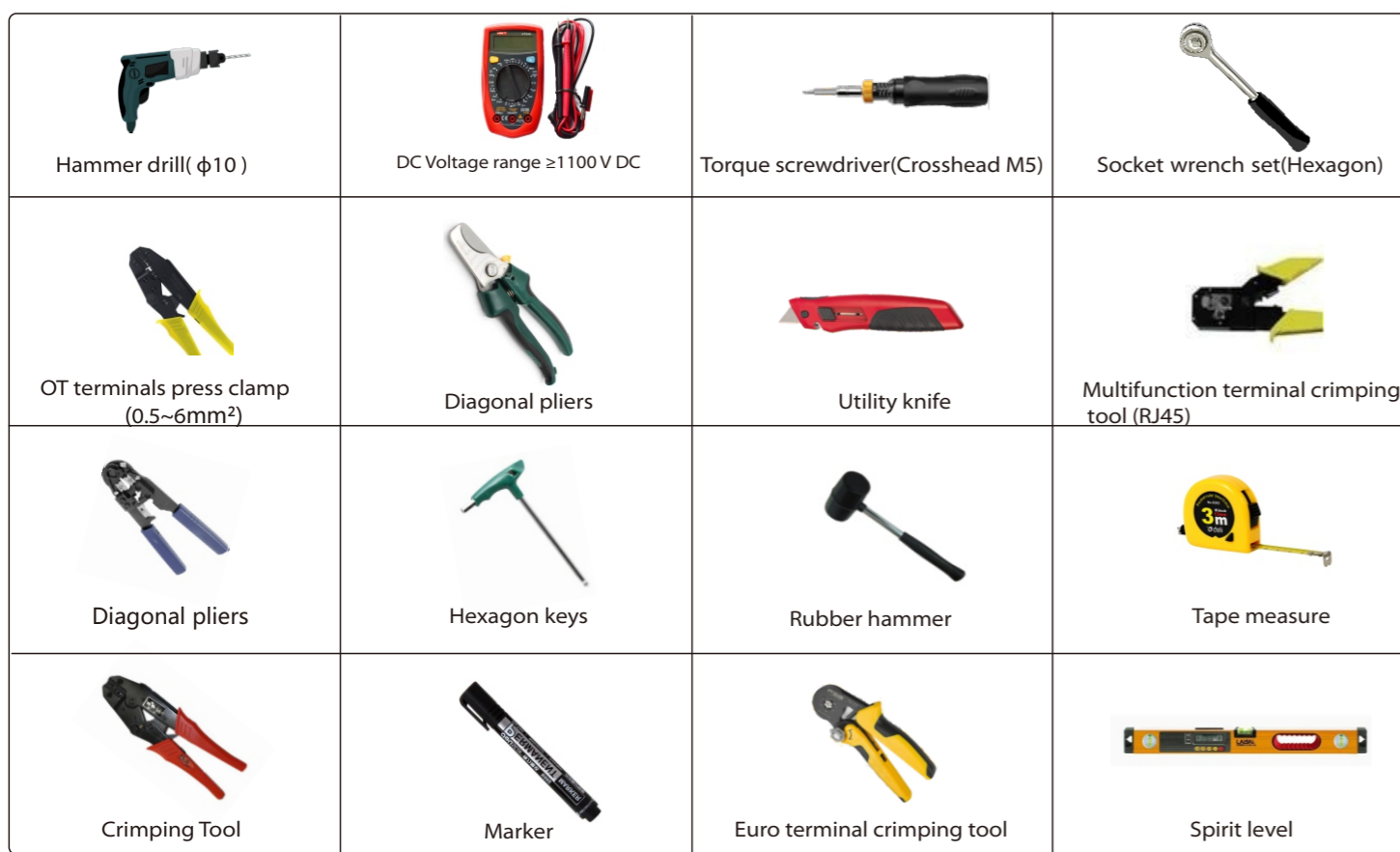

III

Mounting Steps

a) Use a marker to mark drilling holes of the bracket on the wall.

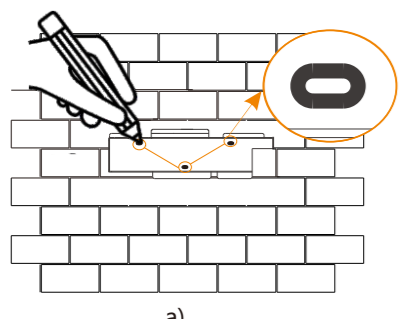

b) Drill holes at marked spots with depth of 80mm.

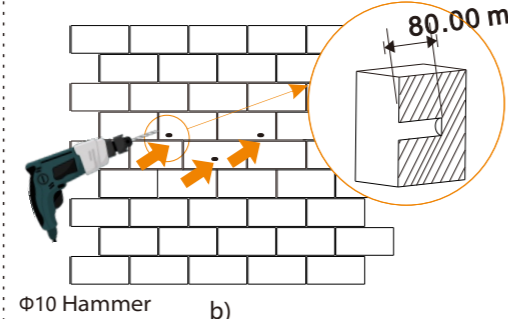

c) Insert expansion bolt into the hole, use rubber hammer to knock the expansion screw bolt into the wall.

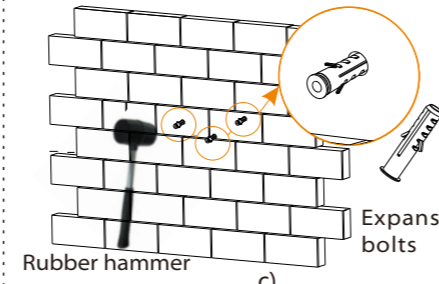

d) The bracket is aligned with the screw uses the inner hexagonal wrench to screw the tapping screw until the expansion bolt "bang" is heard.

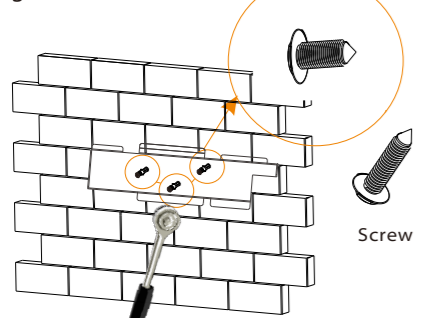

e) Hang the buckle on the inverter to the corresponding position of the backplane.

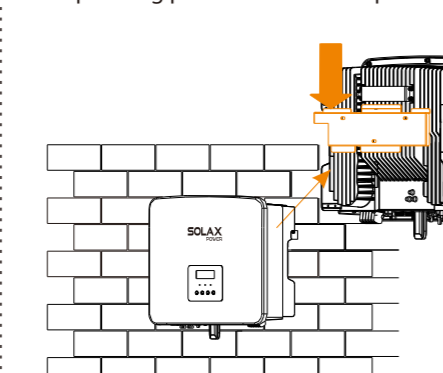

f) Use the inner hexagonal wrench to tighten the inner hexagonal screw on the right side of the inverter.

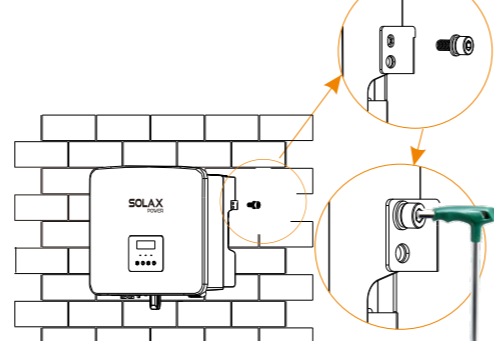

VI

Communication Connection (BMS/Meter/CT/DRM/COM)

• Electric meter connection diagram

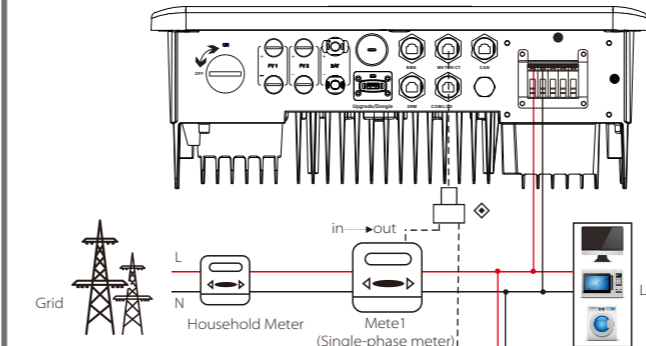

If the user has other power generation equipment (such as inverters) at home and wants to monitor both, X1-Fit G4 inverter provides Meter2 communication function to monitor the power generation equipment. For more information, please contact Solax.

• CT connection diagram

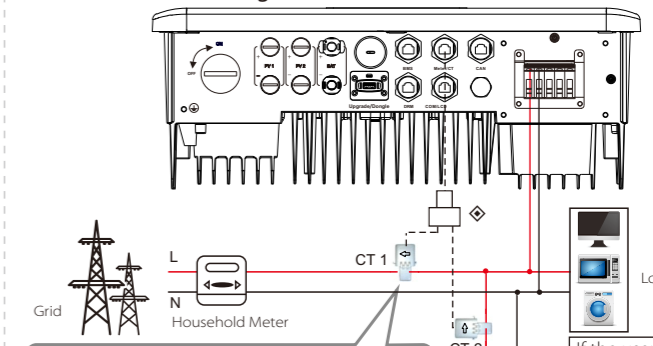

If the user has other power generation equipment (such as inverters) at home and wants to monitor both, X1-Fit G4 inverter provides CT2 communication function to monitor the power generation equipment.

VI Communication Connection (BMS/Meter/CT/DRM/COM)

Note: CT2 Kit, It is a convenient adapter accessory for X1-Fit G4 to monitor the grid-connected inverter. If you need it, please purchase it from the options.

- LCD settings
To select CT, you need to enter Use setting, then enter CT or Meter Setting.

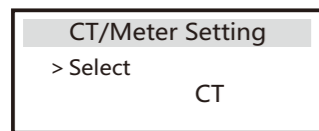

Meter /CT PIN is defined as follows:

1	2	3	4	5	6	7	8
CT1-1	X	CT2-1	485A	485B	CT2-2	X	CT1-2

Note:
The electric meter and CT cannot be connected to one inverter at the same time. The meter cable is connected to pin terminals 4 and 5; the CT cable is connected to pin terminals 1 and 8; the reserved CT cable is connected to pin terminals 3 and 6.

1) To connect the Communication line of the CT line, the lines need to be made on both sides, connecting the RJ45 terminal on one side and the Communication line Adapter on the other.

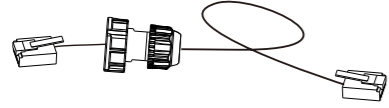

2) One side of the finished cable, Communication line adapter is inserted into the inverter, and one side of the RJ45 terminal is inserted into the CT connection.

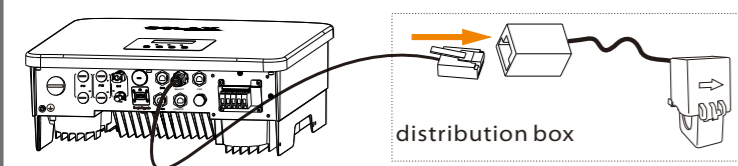

COM Communication

External communication equipment controls the inverter:

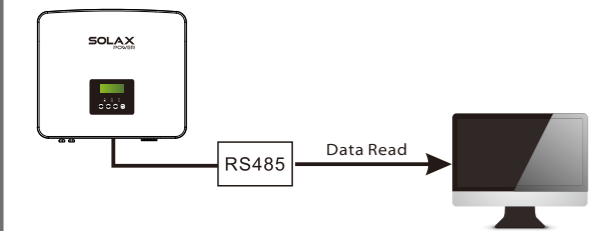

Inverter communication control external equipment:

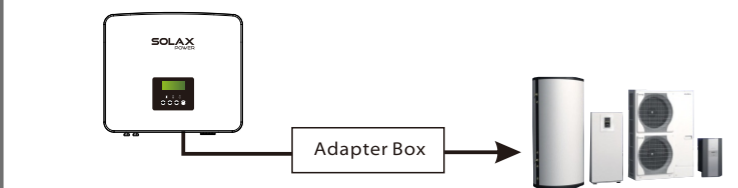

The COM pin is defined as follows:

1	2	3	4	5	6	7	8
Drycontact_A(in)	Drycontact_B(in)	+12V	485A	485B	GND	Drycontact_A(out)	Drycontact_B(out)

Note!
Customers can communicate or control the inverter and external devices through the COM interface. Professional users can use pins 4 and 5 to realize data acquisition and external control functions. The communication protocol is Modbus RTU. For details, please contact SolaX. If the user wants to use the inverter dry contact to control external equipment (such as a heat pump), it can be used with SolaX's Adapter Box. For details, please refer to the Quick Installation Manual of the Adapter Box.

The BMS pin is defined as follows:

1	2	3	4	5	6	7	8
BAT_TEMP	GND	BMS_CANH	BMS_CANL	X	BMS_485A	BMS_485B	

Note!
The BMS port on the inverter is the communication port for connecting the battery. The communication port on the lithium battery must be consistent with the definition of pins 4, 5, 7, and 8 above;

The DRM pin is defined as follows:

1	2	3	4	5	6	7	8
DRM1/5	DRM2/6	DRM3/7	DRM4/8	+3.3V	DRM0(SHUTDOWN)	GND	GND

Note:
For AS4777 DRM function, currently only PIN6 (DRM0) and PIN1 (DRM1/5) are functional, other PIN functions are under

Communication Connection Steps

Step 1. Prepare a communication cable, and then find the communication adapter in the accessory bag.



Step 2 Insert the communication cable through the communication adapter, and peel off the outer insulation layer of 15mm.

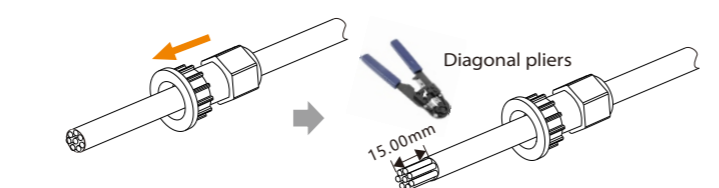

Step 3. Insert the prepared communication cables into the RJ45 terminals in sequence, and then use network cable crimping pliers to press them tightly.

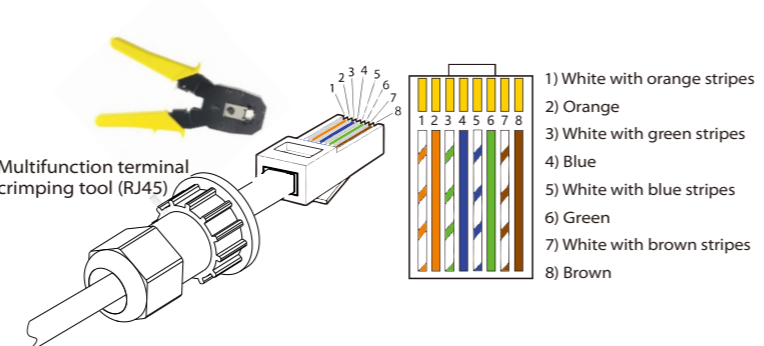

Step 4. Tighten the completed BMS / Meter / CT / DRM / COM / LCD communication line and tighten the waterproof plug.

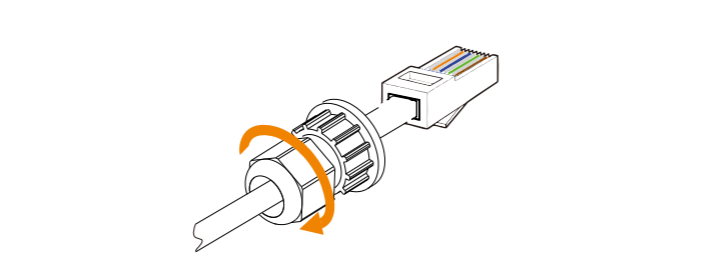

Step 5: Finally, find the corresponding BMS / Meter / CT / DRM / CAN / COM / LCD ports on the inverter and insert the communication cable into the corresponding ports.

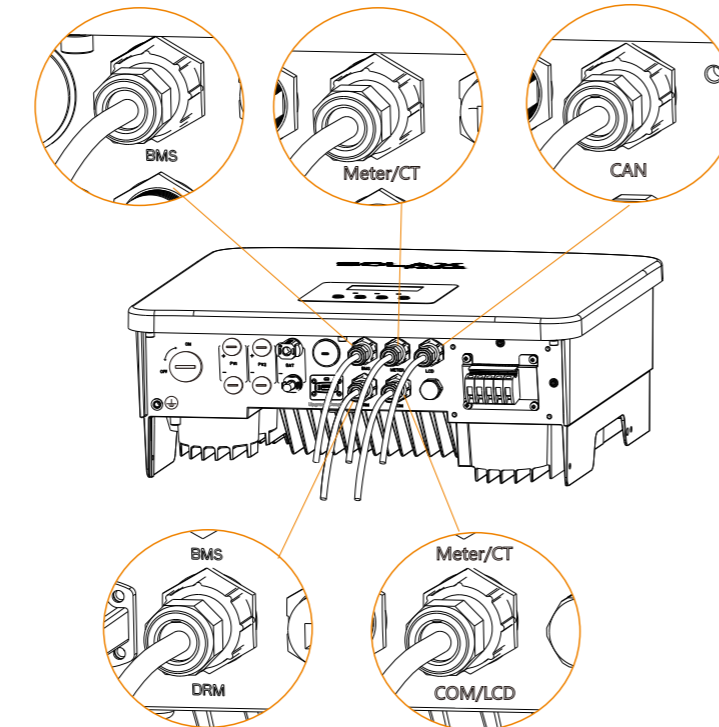

VII Grounding Connection (mandatory)

The ground wire port of X1-Fit G4 M version inverter has been connected, and the W version needs to be wired according to the following steps.

Step 1. Prepare a one-core cable (3-4 mm²), and then find the ground terminal in the accessories.

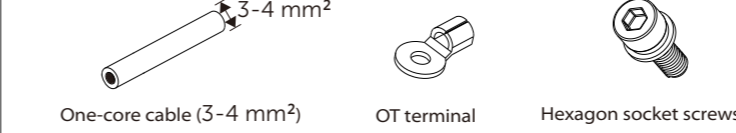

Step 2. Strip the grounding cable insulation (length "L2"), insert the stripped cable into the ring terminal, and then clamp it.

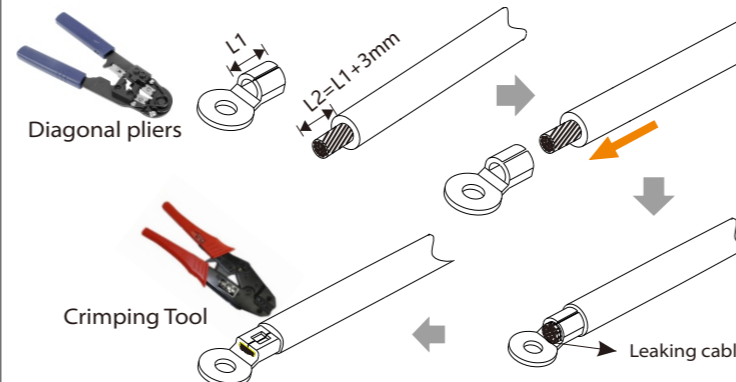

Step 4. Find the ground connection port on the inverter, and screw the ground wire on the inverter with an M5 Allen key.

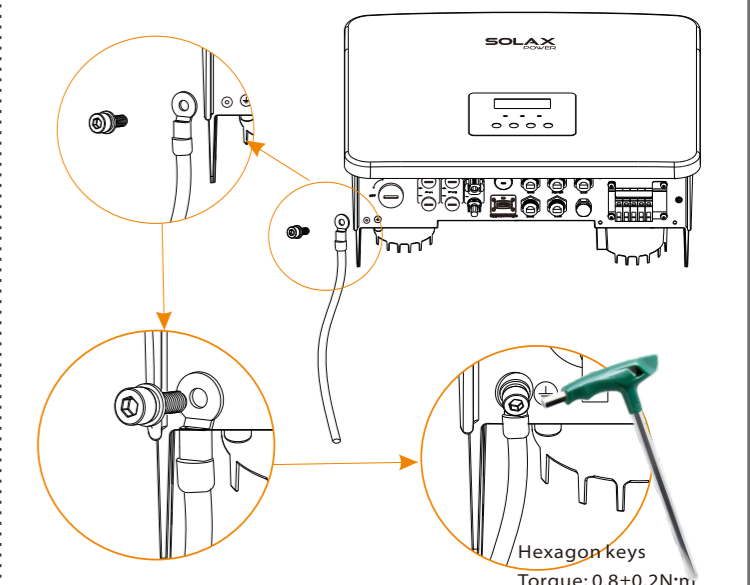

VIII Monitoring Operation

Dongle connection diagram



Wireless monitoring accessories connection steps:

Step 1. First find the DONGLE port of the inverter.

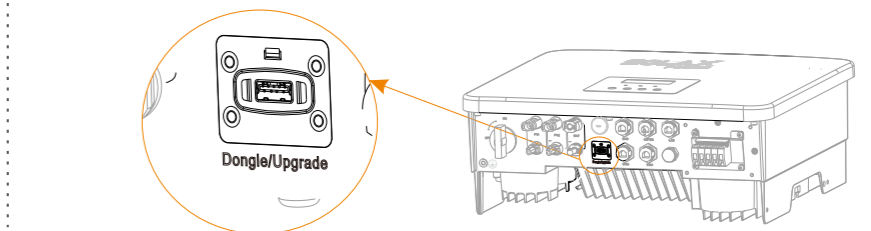

Step 2. Plug Pocket WiFi into the DONGLE port.

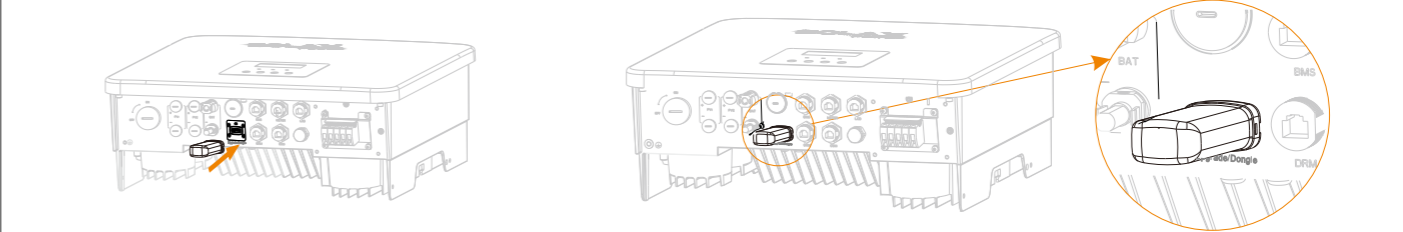

IX Start Guide

1. Set date time



2. Set language

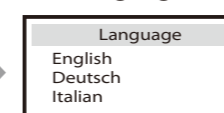

3. Set the safety standard



4. CT/Meter Setting

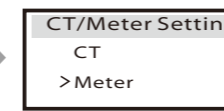

5. Set export control



6. Set work mode

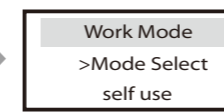

7. Matebox Setting

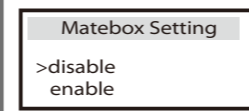

5*. Export Control

This function allows the inverter able to control energy exported to the grid. There are user value and factory value. The factory value is default which can not be changed by user. The user value set by installer must be less than the factory value.

6*. Set work mode
X1-Fit G4 has 4 working modes to choose from when used with a grid-connected inverter. All these work modes is available for on-grid condition only:

Name	Description
Self Use	The self-use mode is suitable for areas with low feed-in subsidies and high electricity prices. ① When the power of PV is sufficient Active Charging or Discharge time period: PV will power the loads firstly, and surplus power will charge to the battery. If the battery is fully charged, then sell the surplus power to the grid. (The inverter will limit the output if feed-in limit or zero feed-in is needed.) (PV > Load, PV → Load → Battery → Grid) ② When the power of PV is insufficient Active Discharge time period: PV + BAT will power the loads together. If the power is still not enough, the remaining power will be taken from the grid. (PV < Load, PV + Battery → Grid → Load) ③ Without PV power Active Charging time period: The grid supplies the loads and also can charge the battery. (PV=0, Grid → Load + Battery) Active Discharge time period: The battery will power the home loads firstly. If the battery power is not enough, the remaining power will be taken from the grid. (PV < Load, PV + Battery + Grid → Load) Battery min SOC can be set: 10%-100%; Charge battery to min SOC can be set: 10%-100%.
Feed-in priority	The Feed-in priority mode is suitable for areas with high feed-in subsidies, but has feed-in power limitation. ① When the power of PV is sufficient Active Charging time period: PV powers the load first, then charges the battery to the set capacity, then sell electricity for the grid, and continues to charge the battery with the remaining power. (PV > Load, PV → Load → Battery → Grid → Battery) Active Discharge time period: PV will power the loads firstly, and surplus power will feed-in to the grid. (PV < Load, PV → Load → Grid) ② When the power of PV is insufficient Active Charging time period: PV will power the loads firstly, the remaining power will be taken from the grid. The battery will not discharge. (PV > Load, PV + Grid → Load) Discharge time period: PV + BAT will power the loads together. If the power is still not enough, the remaining power will be taken from the grid. (PV < Load, PV + Battery + Grid → Load) ③ Without PV power Active Charging time period: The grid will power the home loads and also charge the battery. (PV=0, Grid → Load + Battery) Active Discharge time period: The battery will power the home loads firstly. If the battery power is not enough, the remaining power will be taken from the grid. The inverter will enter into the standby state. (PV=0, Battery + Grid → Load) Battery min SOC can be set: 10%-100%; Charge battery to min SOC can be set: 10%-100%.
Backup mode	The back-up mode is suitable for areas with frequent power outages. Same working logic with "Self-use" mode. This mode will maintain the battery capacity at a relatively high level. (Users' setting) to ensure that the emergency loads can be used when the grid is off. Customers no need to worry about the battery capacity. Battery min SOC can be set: 30%-100%; Charge battery to min SOC can be set: 30%-100%.
EPS	The EPS mode is used when the power grid is off. System will provides emergency power through PV and batteries to supply power to the household loads. (System is necessary) ① When the power of PV is sufficient PV will power the loads firstly, and surplus power will charge to the battery. (PV > Load, PV → Load → Battery) ② When the power of PV is insufficient The remaining power will be taken from the battery. (PV < Load, PV → Load) ③ Without PV power The battery will power the emergency loads until the battery reached the min SOC, then the inverter will enter into the idle mode. (PV=0, Battery → Load) EPS SOC: min condition is adjustable within the range of 10%-25%.

X Start Inverter

Start inverter

After the inverter is checked, the inverter will take the following steps:

Applies to most countries

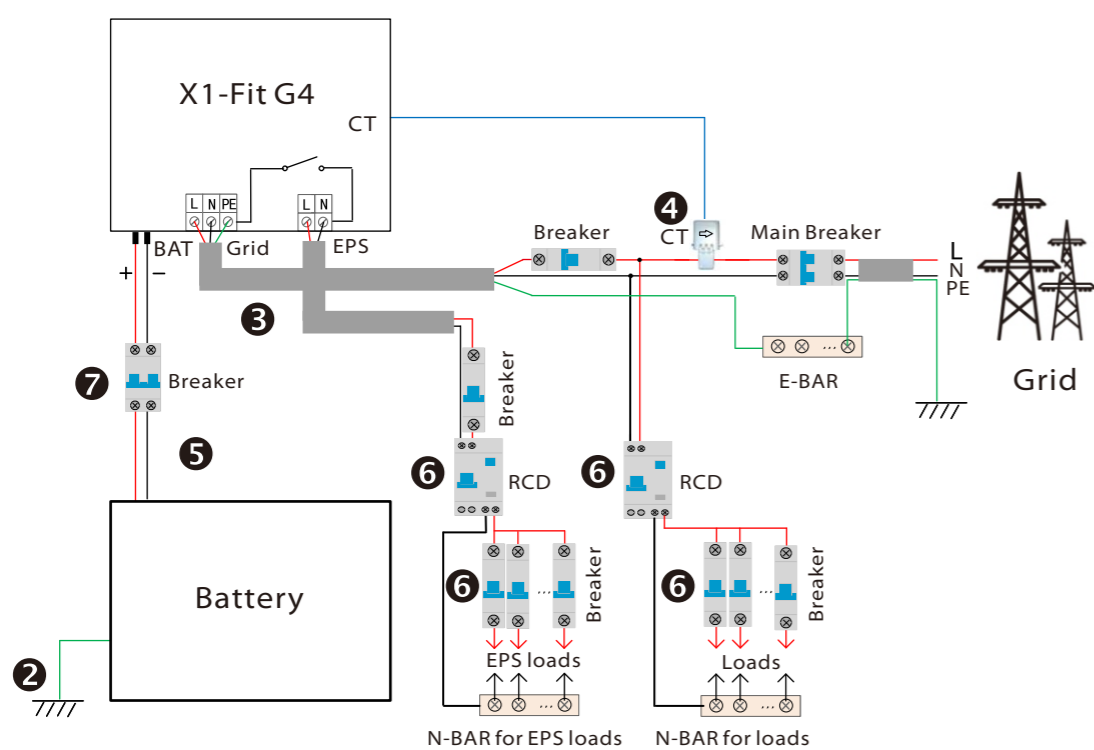

- Make sure that the inverter is fixed on the wall.
- Ensure that all ground wires are grounded.
- Confirm that all AC lines are connected.
- Make sure the CT is connected.
- Make sure the battery is well connected.
- Turn on the Load switch and EPS switch
- Turn on the battery switch.

Long press Enter for 5 seconds to exit the shutdown mode. Mode is the mode when it is turned off for the first time; factory default: off mode)

XI Firmware Upgrading

-In order to upgrade the firmware smoothly, if the DSP and ARM firmware needs to be upgraded, please note that ARM firmware must be upgraded first, then DSP firmware!

-Make sure that this directory is completely consistent with the above table, do not modify the firmware file name. Otherwise, the inverter may not work!

-For X1-Fit G4, ensure that the PV input voltage is greater than 100V (upgrade on sunny days), please ensure that the battery SOC is greater than 20% or the battery input voltage is greater than 90V. Otherwise, it may cause serious failure during the upgrade process!

-If the ARM firmware upgrade fails or stops, please do not unplug the U disk and power off the inverter and restart it. Then repeat the upgrade steps.

Upgrade preparation

- Please check the inverter version and prepare a U disk (USB 2.0/3.0) and personal computer before upgrading.
- Please contact our service support through service@solaxpower.com to obtain the firmware, and store the firmware in the U disk according to the following path:
Update:
For ARM file: update\ARM\618.00361.00_Fit_X1G4_ARM_V1.01_0710.usb*;
For DSP file: update\DSP\618.00360.00_Fit_X1G4_DSP_V1.01_0710.usb*;

Upgrade steps

Step 1. Please save the "Upgrade" firmware in your U disk first, and press the "Enter" button on the inverter screen for 5 seconds to enter the OFF mode.

Step 2. Locate the "update" port of the inverter, use a flat-blade screwdriver or coin with the same width to remove the waterproof cover, and insert the U disk.

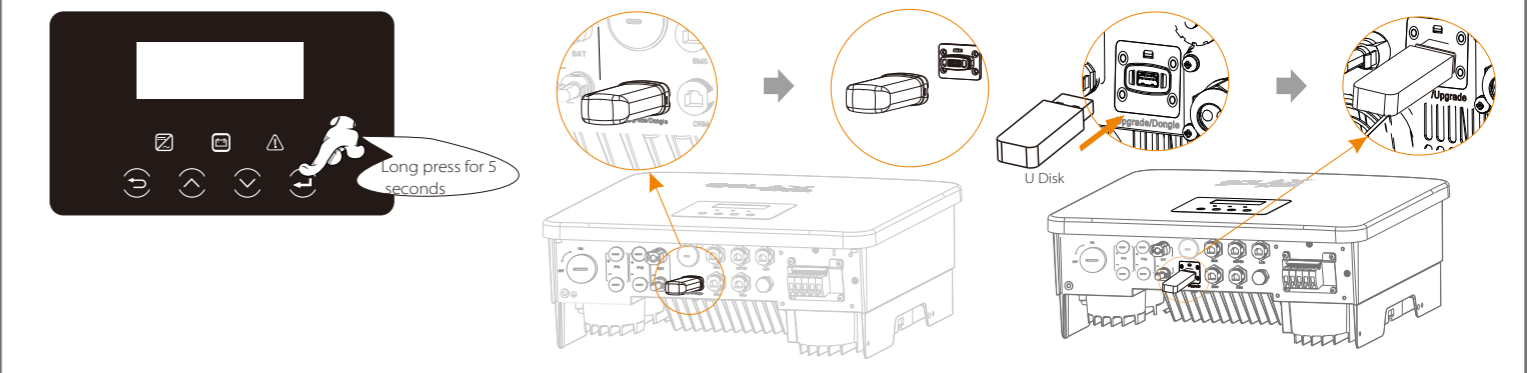

Step 3. LCD operation, enter the upgrade interface "update", as shown below (a); Please press the up and down keys to select ARM, then press the bottom of the page to select "OK", press the enter key to enter the software version interface:

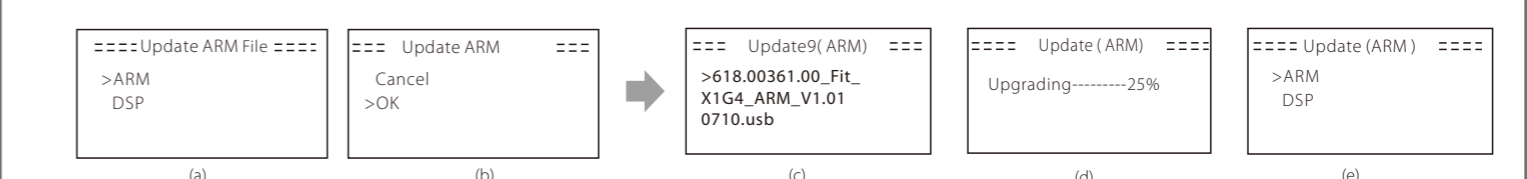

Step 4. Please confirm the new firmware version again and select the firmware to upgrade. The upgrade takes about 20 seconds. (d) When it is completed, the LCD screen returns to the "Update" page.

