

SOFAR

# USER MANUAL

ESI 3-6K-S1



Shenzhen SOFARSOLAR Co., Ltd.



# Content

Preface	1
<b>1 Basic Safety Information</b>	<b>3</b>
1.1 Requirement for Installation and Maintenance	3
1.2 Symbols and Signs	7
<b>2 Product Introduction</b>	<b>9</b>
2.1 Product Overview	9
2.2 Product Model Description	10
2.3 Product Capacity Description	11
2.4 Product Appearance	12
2.5 Buttons and Indicator Lights	14
2.6 Product label	16
<b>3 Product Installation</b>	<b>17</b>
3.1 Checking Before Installation	17
3.2 Installation Tools	17
3.3 Installation environment	19
3.4 Installation Space	20
3.5 Product Installation	22
<b>4 Electrical Connection</b>	<b>26</b>
4.1 Attentions Before Connection	26
4.2 Preparation of Connection Cables	26

---

4.3 Electrical Connection for Internal System	27
4.4 External Electrical Connection	31
4.5 Install the cover	48
4.6 Parallel system	49
4.7 System Electrical Topology	51
<b>5 Commissioning</b>	<b>54</b>
5.1 Checking Before System Starting	54
5.2 Electrify for the First Time (Important)	54
5.3 Steps of Shutdown	57
5.4 Menu	58
5.5 Monitoring description	75
<b>6 Trouble shooting and maintenance</b>	<b>76</b>
6.1 Troubleshooting	76
6.2 Daily Maintenance	84
<b>7 Datasheet</b>	<b>85</b>
<b>8 Manufacturer's Warranty and Liability Terms</b>	<b>89</b>

## Preface

### Notice

The products, services or features you purchased shall be subject to the company's commercial contracts and terms. All or part of the products and services described in this document may not within the scope of your purchase. Unless additional terms and conditions in your contract, the company does not make any statement or guarantee on the contents of this document. In addition, the term "Product" as described in this document refers broadly to "ESI Series products".

### Save this Instruction

This manual must be considered as an integral part of the equipment. Customer can print the electronic version to hard copy and keeping properly for future reference. Anyone who operates the device at any time must operate in accordance with the requirements of this manual.

### Copyright Declaration

The copyright of this manual belongs to SHENZHEN SOFARSOLAR Co., Ltd. Any corporation or individual should not plagiarize, partially cope or fully copy (including software, etc.), not allow to duplication and publication in any form and any way. All rights reserved, SOFAR reserves the right of final interpretation. This manual subject to modify according to user's or customer's feedback. Please check our website at <http://www.sofarsolar.com> for latest version.

### Document Updates

V4.1 2024-06-11

● **Outline**

Please read the product manual carefully before installation, operation or maintenance. This manual contains important safety instructions and installation instructions that must be followed during installation and maintenance of the equipment.

● **Scope of Validity**





This product manual describes the installation, electrical connections, commissioning, maintenance and troubleshooting of ESI Series products.

● **Target Group**

This manual is for qualified electricians. The tasks described in this manual only can be performed by qualified electricians.

● **Symbols Used**

The following types of safety instruction and general information appear in this document as described below:

 <b>Danger</b>	<p>“Danger” indicates a hazardous situation which, if not avoided, will result in death or serious injury.</p>
 <b>Warning</b>	<p>“Warning” indicates a hazardous situation which, if not avoided, could result in death or serious injury.</p>
 <b>Caution</b>	<p>“Caution” indicates a hazardous situation which, if not avoided, could result in minor or moderate injury.</p>
 <b>Attention</b>	<p>“Attention” indicates there are potential risks, if fail to prevent, may lead to equipment cannot normally or property damage.</p>
 <b>Note</b>	<p>“Note” provides additional information and tips that are valuable for the optimal operation of the product, will help you to solve a problem or save your time.</p>

# 1 Basic Safety Information

## Outlines of this Chapter

Please read the instruction carefully. Faulty operation may cause serious injury or death.

	If you have any question or problem when you read the following information, please contact SHENZHEN SOFARSOLAR CO., Ltd.
Note	

## 1.1 Requirement for Installation and Maintenance

### Common Requirements

The product must be installed in full compliance with national and local power grid standards and regulations.

Before installing and adjusting the produce, please read all of instructions, cautions and warnings in this manual.

Before connecting the product to the electrical utility grid, contact the local utility company for allowance. Also, this connection must be made only by qualified electrician.

When any maintenance or repair is required, please contact the nearest authorized maintenance center. If you don't know which service center is closest to you, please contact your local distributor. Don't repair the product by yourself, which may lead serious injury or damage.

Before installing and maintaining the device, using the DC switch to cut off the high voltage direct current of the photovoltaic array. Otherwise, the high voltage may cause serious injury.

- ✧ The product should be placed in a well-ventilated place. Do not place the product in a sealed or air-tight position or cabinet, otherwise it will affect the operation performance and system life of the energy storage system.
- ✧ Avoid direct sunlight. Do not place this product near stoves and fire sources. Otherwise, the lithium battery in the product system will leak

or even explode.

- ✧ The maintenance personnel of this product must understand the knowledge and skills related to inverter and battery maintenance.
- ✧ ESI Series products are transformerless inverter which requires the positive pole and negative pole of the PV array are NOT grounded. Otherwise, it will cause inverter failure. In the PV system, all non-current-carrying metal parts (such as mounting frame, combiner box enclosure, etc.) should be connected to earthed.
- ✧ Reminder: Do not disassemble and destroy the battery. The toxic electrolyte in the battery can damage your skin and eyes.
- ✧ Caution: Comply with the following requirements during the installation and maintenance of the product:
  - A) Remove watches, rings and other metal objects from your body.
  - B) Use tools with insulated handles.
  - C) Wear rubber gloves and shoes.
  - D) Do not place tools or metal objects on the battery.
  - E) Close the inverter before connecting/disconnecting the battery and the energy storage inverter.
  - F) Battery +/- pole shall be isolated from ground.
- ✧ Installation and maintenance personnel requirements

When the product is in the running state, some parts may be electrified and hot. Improper use, improper installation or operation may result in serious injury to person or property. Transport, loading, unloading, installation, start-up and maintenance operations must be performed by a qualified electrical engineer (all accident precautions in force in the user's country must be followed!) SOFAR will not be responsible for any personal injury or property injury caused by improper use.



### ◇ Installation location requirement

Please install the product according to the following section. Place inverter in an appropriate bearing capacity objects (such as solid brick wall, or strength equivalent mounting surface, etc.) and make sure inverter vertical placed. A proper installation location must have enough space for fire engine access in order for maintenance if faulty occur. Ensure the inverter is installed in a wall ventilated environment and have enough air cooling cycle. Air humidity should less than 90%.

### **Transport Requirement**

Inverter is in the good electrical and physical condition when it ship out from factory. During transport, inverter must be placed in its original package or other proper package. Transportation company should responsible for any damage during transport period.



If you find any packing problems that may cause the damage of inverter or any visible damage, please notice the responsible transportation company immediately. You can ask your installer or SOFAR for help is necessary.

This product contains battery module through UN38.3, belongs to the ninth category of dangerous goods. Therefore, loading and unloading must comply with local laws and regulations and industry standards during transportation. Rough loading and unloading may cause short circuit or damage to batteries in containers, which may result in battery leakage, breakage, explosion, or fire.



- ◇ Shipping complies with the IMDG CODE and the International Maritime Dangerous Goods CODE.
- ◇ For land transportation, comply with ADR or JT T617 shipping requirements.
- ◇ Comply the regulatory requirements of the transport regulatory authorities of the country of origin, route and destination.
- ◇ Comply with international regulations for the transport of dangerous goods and the supervision requirements of the corresponding national transport regulatory authorities.

### Electrical Connection



Please comply with all the current electrical regulations about accident prevention in dealing with the current inverter.

	Before the electrical connection, use opaque material to cover the PV modules or disconnect PV string DC switch. PV arrays will produce dangerous voltage if it is exposure under sun. When installing a battery, check the positive and negative terminals of the battery and turn off the battery.
<b>Danger</b>	
	All operation must accomplish by certified electrical engineer
<b>Warning</b>	<ul style="list-style-type: none"> <li>● Must be trained;</li> <li>● Completely read the manual operation and understand all information.</li> </ul>
	Must get permission by local utility company before connecting to grid and the connection must be done by certified electrical engineers.
<b>Attention</b>	

### Operation Cautions

	Touching the utility grid or the terminal conductors can lead to lethal electric shock or fire! Do not touch non-insulated cable ends, DC conductors and any live components.
<b>Danger</b>	Attention to any electrical relevant instruction and document.
	Enclosure or internal components may get hot during operation. Please wear insulated gloves.
<b>Attention</b>	

### Maintenance and Repair Cautions

	Before any repair work, turn OFF the AC circuit breaker between the product and electrical grid first, then turn OFF the DC switch. After turning OFF the AC circuit breaker and DC switch wait for at least 5 minutes before carry any maintenance or repair work.
<b>Danger</b>	
	Product should not work again until removing all faults. If any repair work is required, please contact local authorized service center. Should not open the product cover without authorized permit. SOFARSOALR does not take any responsibility for that.
<b>Attention</b>	

**EMC/Noise Level**





Electromagnetic compatibility (EMC) refers to that on electrical equipment functions in a given electromagnetic environment without any trouble or error, and impose no unacceptable effect upon the environment. Therefore, EMC represents the quality characters of an electrical equipment.

- The inherent noise-immune character: immunity to internal electrical noise
- External noise immunity: immunity to electromagnetic noise of external system

Noise emission level: influence of electromagnetic emission upon environment











	Electromagnetic radiation from the product may be harmful to health! Please do not continue to stay away from the product in less than 20cm when it is working
<b>Danger</b>	

**1.2 Symbols and Signs**

	High voltage of inverter may be harmful to health! Only certified engineer can operate the product; Juveniles, Disable, should not use this product; Keep this product out of the reach of children;
<b>Danger</b>	
	Caution of burn injuries due to hot enclosure! Only touch the screen and pressing key of the product while it is working
<b>Caution</b>	
	PV array should be grounded in accordance to the requirements of the local electrical grid company
<b>Attention</b>	
	Ensure the maximum DC voltage input is less than the product's maximum DC voltage (including in low temperature condition). Any damage cause by over-voltage, SOFAR will not take the responsibility including warranty
<b>Warning</b>	

The product has some safety symbols on it. Please read and fully understand the content of the symbols before installation.

### Sings on the inverter module

Symbols	Name	Explanation
	This is a residual voltage in the inverter module!	After disconnect with the DC side, there is a residual voltage in the inverter module, operator should wait for 5 minutes to ensure the capacitor is completely discharged.
	Caution of high voltage and electric shock	The inverter module operates at high voltages. Prior to performing any work on the product, disconnect the product from voltage sources. All work on the product must be carried out by qualified persons only.
	Caution of hot surface	The inverter module can get hot during operation. Avoid contact during operation. Prior to performing any work on the product, allow the product to cool down sufficiently.
	Comply with European standard (CE) certification	The product complies with the CE Certification
	Grounding Terminal	Connect the inverter module to the ground bar for grounding protection
	Observe the documentation	Read all documentation supplied with the product before install
	Positive pole and negative pole	Positive pole and negative pole of the input voltage (DC)
	Temperature	Indicated the temperature allowance range
	This side up	Inverter must always be transported, handled and stored in such a way that the arrows always point upwards.
	RCM (Regulatory Compliance Mark)	The product complies with the requirements of the applicable Australian standards

## 2 Product Introduction

### 2.1 Product Overview

#### 2.1.1 Product Brief Introduction

ESI 3-6K-S1 series inverters support multi-power segment operation. Including PV, energy storage, grid connection, EPS and other corresponding functions in one. PV is two independent MPPT tracking channels, suitable for different installation environments. The ESI 3-6K-S1 inverter can be installed with or without batteries. If the inverter needs to be used with batteries, it can only use BTS 5K battery model. The battery type is LiFePO<sub>4</sub> (LFP). The maximum energy storage capacity is 5kWh-30kWh. The inverter has the advantages of multiple working modes in operation. Under different modes, energy can be managed and distributed according to the actual situation to meet different needs. Flexible monitoring mode, support RS485. Also support: WIFI/Bluetooth remote control function.

The main features are as follows:

- Stack integrated design, convenient installation, simple maintenance;
- Built-in battery pack equalization management unit to improve battery available capacity;
- Photovoltaic maximum input current 16A, applicable to large current and double-sided module;
- Battery side complete electrical isolation, safer system;
- UPS function to ensure the stable operation of critical load;
- Supports a mixture of new and old batteries;
- Supports battery switch off with a button.

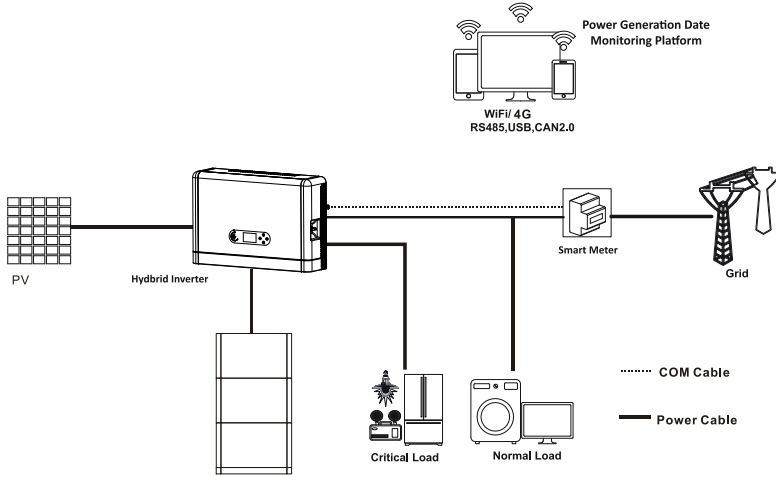

Figure 2.1.1-1 ESI series application principle diagram

## 2.2 Product Model Description

**ESI 5K-S1**  

  
①
②
③

Figure 2.2-1 Inverter Model Identifiers

Table 2.2-1 Inverter Model demonstration

Meaning	Meaning	Specification
①	Product Model	Stacked optical storage all in one machine
②	Power Grade	5K, the power grade of inverter is 5kw. Power grade list: 3kw/3.68kw/4kw/4.6kw/5kw/6kw
③	Inverter Model	Single-phase hybrid energy storage inverter

### 2.3 Product Capacity Description

The ESI series residential energy storage system supports power and capacity expansion and supports up to six inverter modules in parallel. One inverter module supports up to six batteries expansion modules.

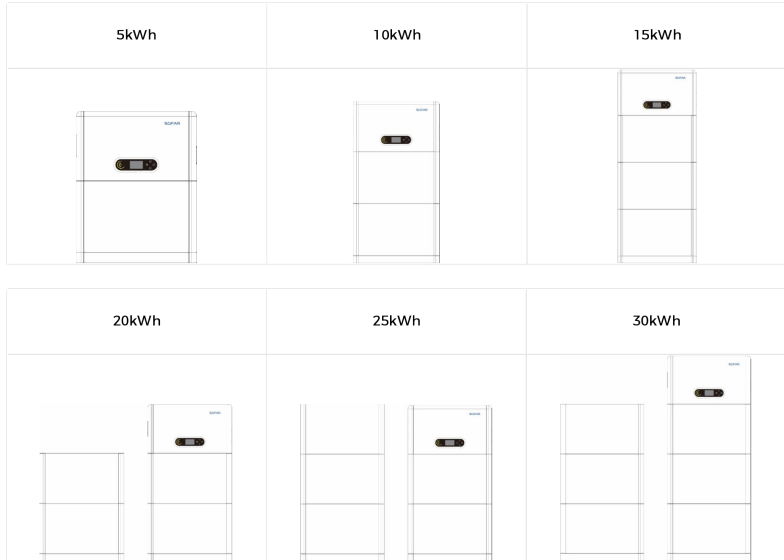

Figure 2.3-1 Storage Capacity Description

	<p>This product contains only inverter modules.</p>
<p>Note</p>	

## 2.4 Product Appearance

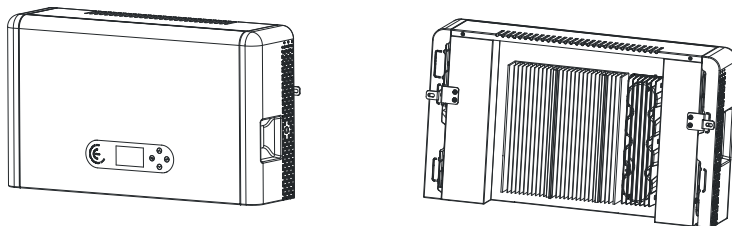
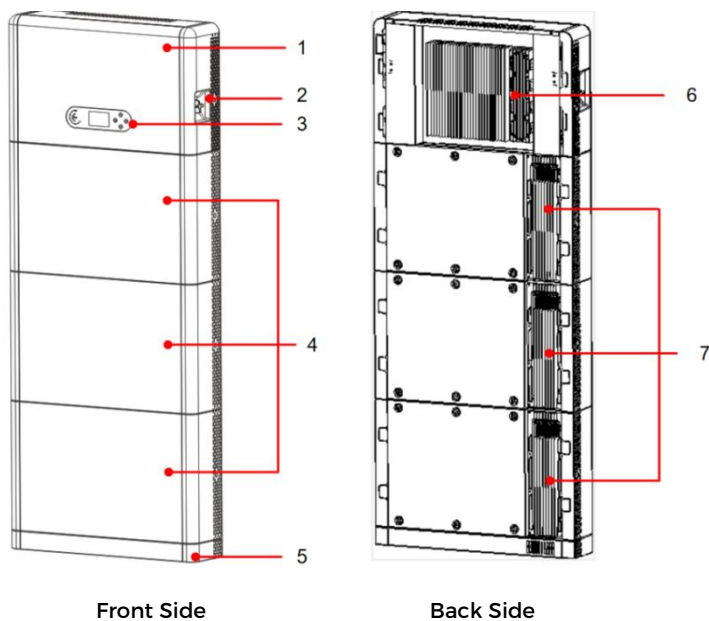

Figure 2.4-1 Inverter front side and back side



Front Side

Back Side

Figure 2.4-2 System front side and back side

1	Inverter	5	Pedestal
2	DC Switch	6	Inverter Radiator
3	LCD display screen	7	Battery Module Radiator
4	Battery Module		



### 2.4.1 Inverter Port

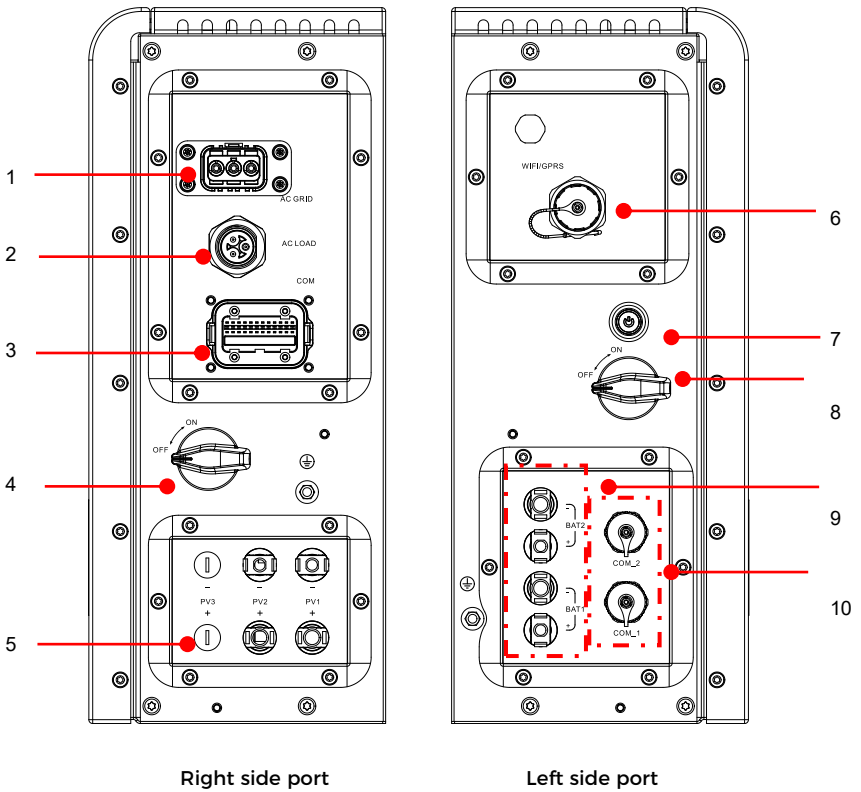

Figure 2.4.1-1 Inverter port diagram

1	Grid connection port	6	WIFI/4G port
2	Load connection port	7	Battery button switch
3	Inverter signal port	8	Battery DC switch
4	PV DC Switch	9	Battery connection port
5	PV input port	10	Battery signal port

## 2.5 Buttons and Indicator Lights

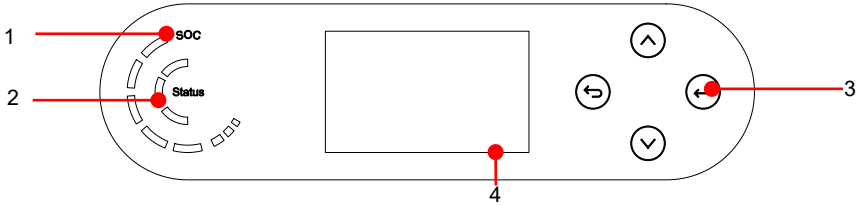





Figure 2.5-1 Buttons and indicator lights

1	System power indicator	3	Buttons
2	System status indicator	4	LCD screen







### 2.5.1 Buttons

- ✧ Press  "back" to the previous screen or enter the main interface.
- ✧ Press  "up" to the upper menu option or value plus 1.
- ✧ Press  "down" to the lower menu option or value minus 1.
- ✧ Press  "ok" to select the current menu option or switch to the next digit.

### 2.5.2 System status indicator

System Status	Indicator		
	Blue light	Green light	Red light
On-grid	ON		
Standby(On-grid)	Flashing		
Off-grid		ON	
Alarm			ON

### 2.5.3 Battery capacity indicator

Icon	Battery capacity	Capacity explanation
	80%-100%	The battery capacity is full
	60%-80%	
	40%-60%	
	20%-40%	
	5%-20%	The battery capacity is insufficient, and the battery generates a low voltage alarm.
	0%-5%	The battery enters the standby state

## 2.6 Product label

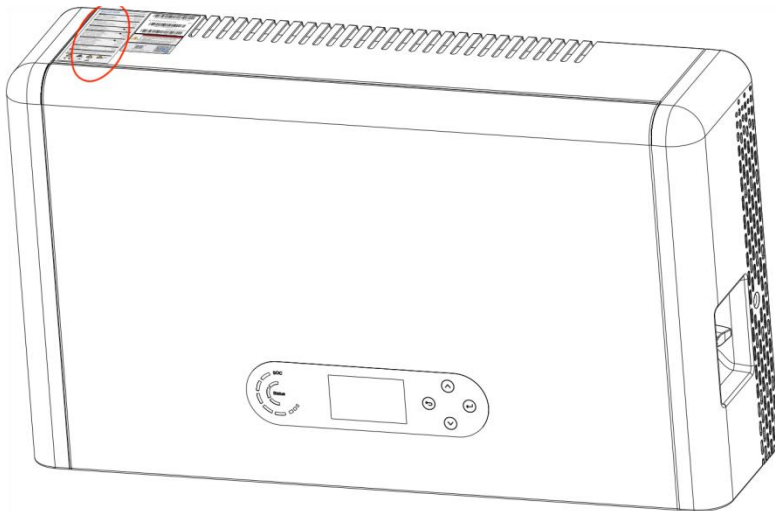

Figure 2.6-1 The location of the label



Note

The picture is only for reference, please make the object as the standard.

### 3 Product Installation



#### 3.1 Checking Before Installation



##### Checking Outer Packing Materials



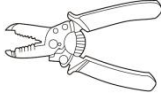

Before opening the battery and inverter package, check whether the outer package is damaged, such as holes and cracks, and check the inverter and battery model. If any damage is found or the inverter and battery model does not match your requirements, please do not open the product package and contact your distributor as soon as possible.

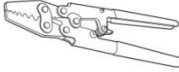
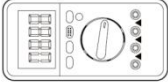
#### 3.2 Installation Tools

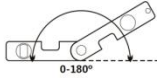
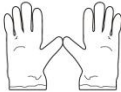
Before installation, prepare the following tools:

NO	Tool	Model	Function
1		Hammer drill Recommend Drill @ Φ8mm	Used to drill holes on the wall.
2		Screwdriver	Remove and install screws and wires
3		Cross screwdriver	Remove and install screws and wires
4		Wire stripper	Used to peel cable

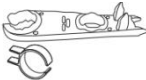
5		M6 socket head wrench	Secure the backplane and inverter
6		Crimping Tool	Use to crimp cable on grid side, load side and CT extensive cable
7		Multimeter	Check whether the cable connection is correct, the positive and negative terminals of the battery are correct, and the grounding is reliable
8		Marker	Mark signs
9		Measuring tape	Measure distance
10		Level	Ensure the rear panel is properly installed
11		ESD gloves	Installer wear when installing product

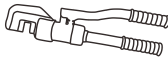
12		Safety goggle	Installer wear when drill holes
13		Mask	Installer wear when drill holes
14		Removal Tool	Remove the output terminal of the battery module
15		sleeve	Install Fixed support rack
16		Crimping tools	Used to crimp OT connector

### 3.3 Installation environment

- ❖ Choose a dry, clean, neat and convenient location for installation.
- ❖ Machine ambient temperature: -10°C~50°C;
- ❖ Relative humidity: 5-95% (non-condensing);
- ❖ The product should be placed in a well-ventilated place;
- ❖ There are no inflammable and explosive objects near the installation position of the product;
- ❖ The product system inverter AC over-voltage level is three;
- ❖ The highest altitude of the installation environment is 4000m.

The installation position of the product should be chosen to avoid direct sunlight and snow position.

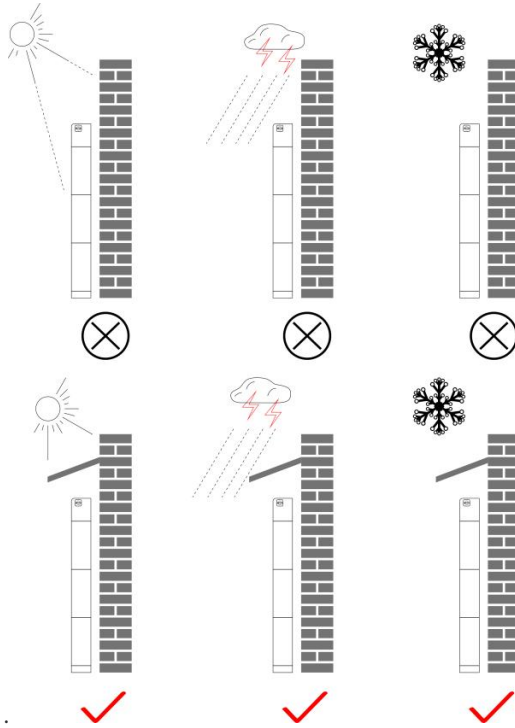

Figure 3.3-1 Installation Environment Diagram

### 3.4 Installation Space

To ensure sufficient space for installation and heat dissipation, reserve sufficient space around the ESI series household energy storage system. The requirements are as follows:



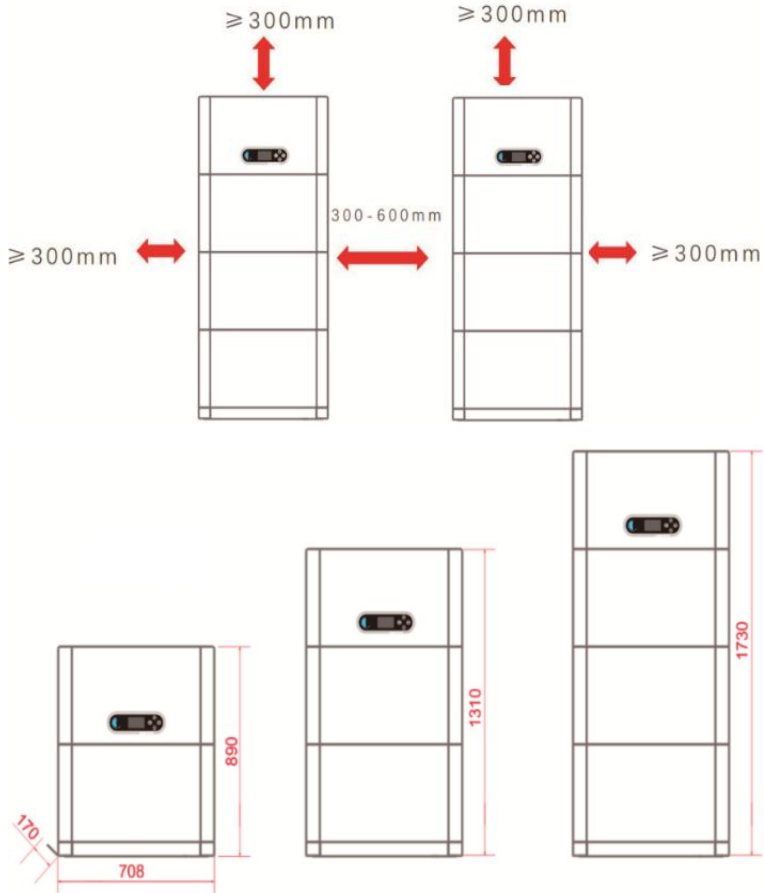

Figure 3.4-1 Installation space diagram

### 3.5 Product Installation

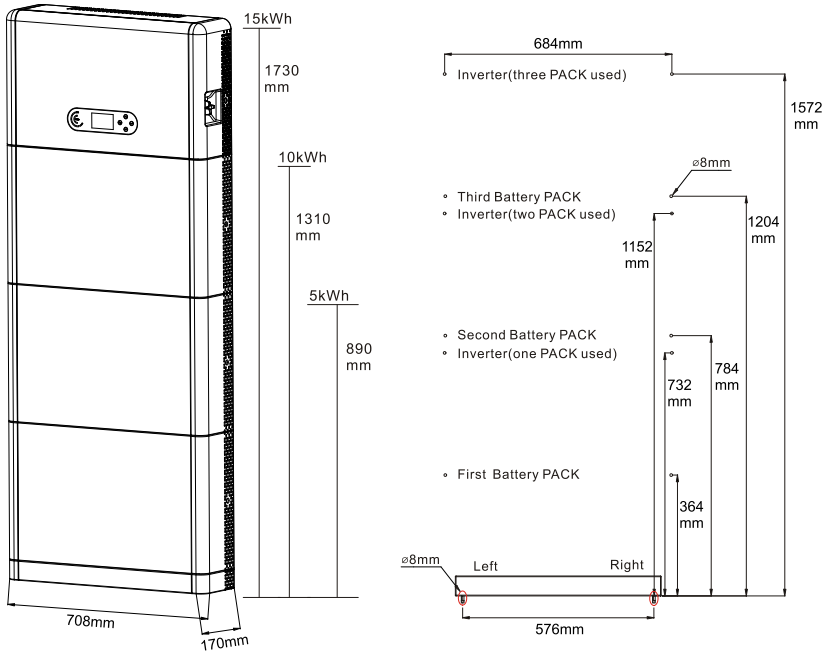

Figure 3.5-1 ESI series installation dimensions diagram

#### Pedestal installation

Procedure :

1 ) Place the pedestal against a wall and keep it 10 to 25mm away from the wall. Adjust the hole positions using a level, and mark the hole positions using a marker.

2 ) To install the pedestal, remove the pedestal, drill holes using a hammer drill (  $\phi$  8mm, depth range 60-65 mm), and tighten expansion screws to ensure that the base is securely installed.

3 ) Use a marker to mark holes for securing the battery modules and

inverters based on the dimensions shown in Figure 3.5-2.

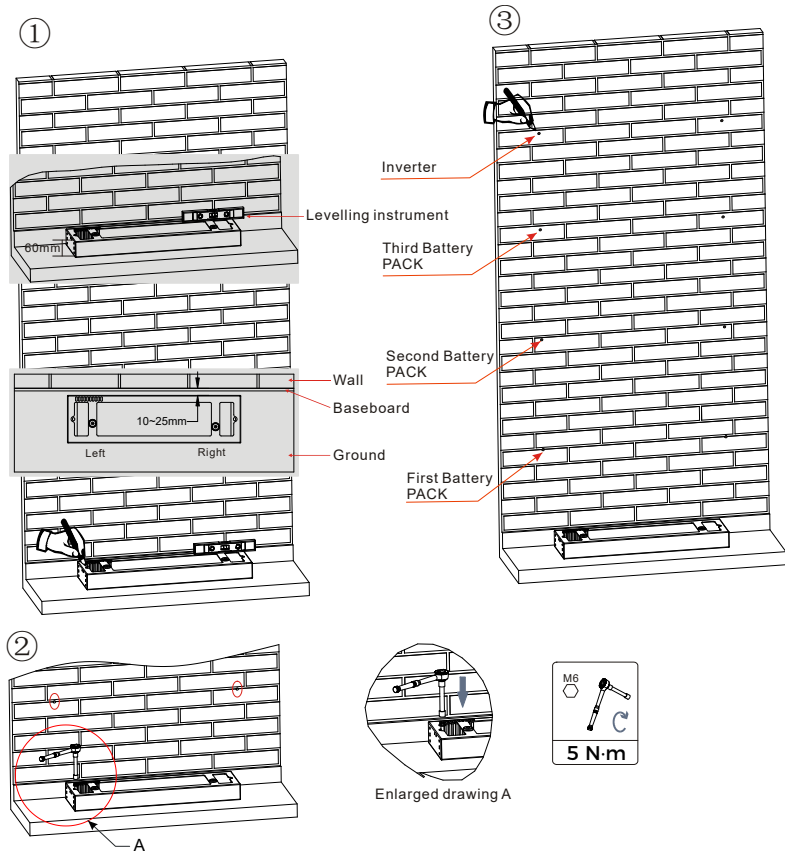

If holes cannot be drilled on the ground, the battery expansion modules must be secured on the wall

Figure 3.5-2 Pedestal installation

**Fixed installation between modules:**

Procedure:

- 1 ) Align the first battery module on the floor pedestal.

2 ) Install connectors on both sides and tighten the six screws using a cross screwdriver.

3 ) Install the remaining battery modules and inverters from bottom to top. (Before installing the next module, ensure that the screws on the side connectors of the previous module are firmly installed.)

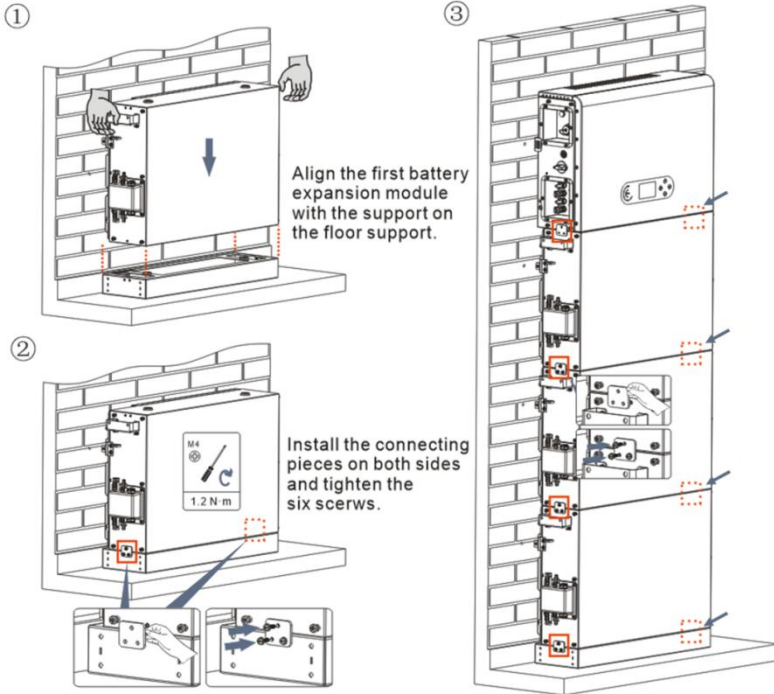

Figure 3.5-3 Battery module and inverter installation diagram

**Support rack installation:**

Procedure:

1 ) Drill holes with a hammer drill ( $\phi$  8mm, depth range 60-65 mm).

Reposition and drill the holes, if the original one has a large deviation.

- 2 ) Install the support rack B on the wall, and fastening expansion bolt.
- 3 ) Adjust the support rack A, make sure the holes are matched between rack A and rack B.
- 4 ) Connect and fix the rack A and rack B with M6\*16 screws.

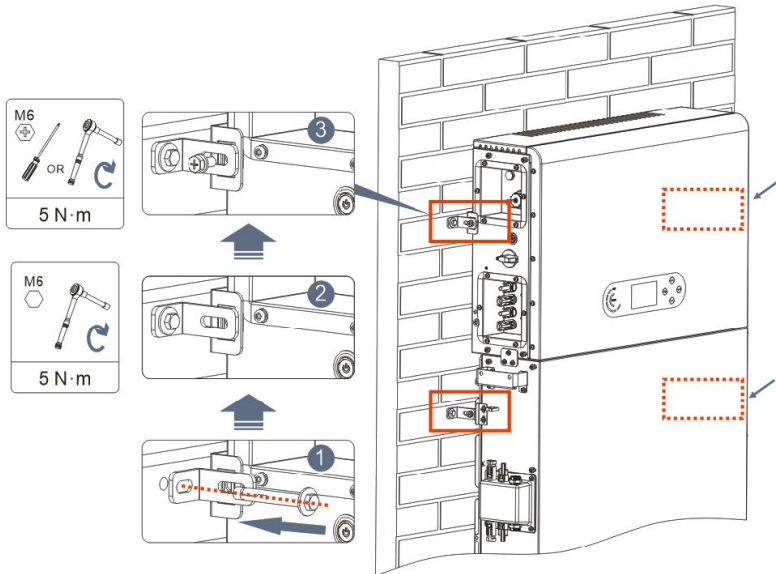

Figure 3.5-4 Schematic diagram of wall fixing installation

## 4 Electrical Connection

### 4.1 Attentions Before Connection

	<p>The voltage in the power conversion circuit of this product is very high. Fatal danger of electric shock or severe burns. All electrical connections of photovoltaic modules, inverters and battery systems must be carried out by qualified personnel. Wear rubber gloves and protective clothing (protective glasses and boots) when operating high voltage/current systems such as inverters and battery systems.</p>
<p>Attention</p>	
	<p>This product is mainly applied to photovoltaic energy storage systems for household use. If not used according to the instructions, the protection provided by the equipment may be damaged.</p>
<p>Attention</p>	

### 4.2 Preparation of Connection Cables

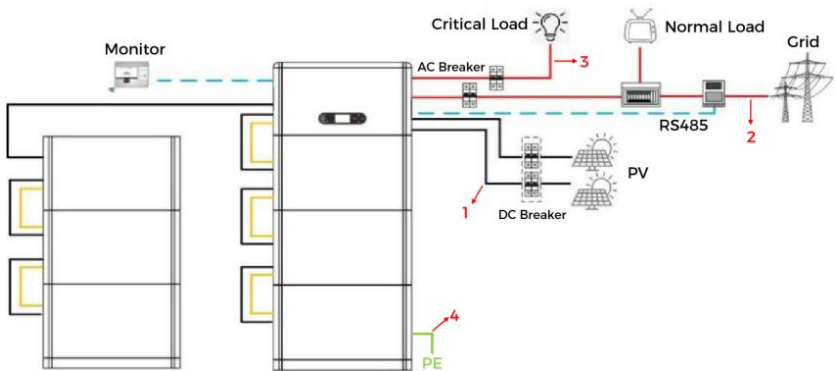

Figure 4.2-1 System connection diagram

Table 4.2-1 Cables prepared by customers

No	Cable	Recommended specifications
1	PV connection cable	UL10269 12AWG
2	AC Grid connection cable	UL10269 8AWG
3	EPS connection cable	UL10269 10AWG
4	Grounding cable	UL10269 8AWG

### 4.3 Electrical Connection for Internal System

#### 4.3.1 Internal protection grounding cable connection

Connect the grounding cables of the battery module and inverter as shown in Figure 4.3.1-1.

	<p><b>Be sure to ground for safety.</b></p> <ul style="list-style-type: none"> <li>• The protective grounding of the chassis shell cannot replace the PGND cable of the LOAD Port. Ensure that the two PGND cables are reliably connected.</li> <li>• When multiple inverters are deployed, ensure that the protection ground points of all inverters are equipotential connected.</li> </ul>
<p><b>Attention</b></p>	

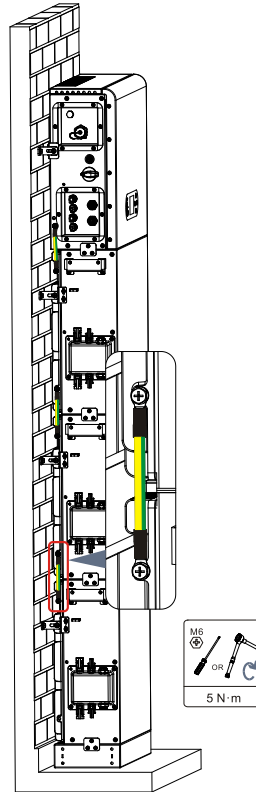

Figure 4.3.1-1 Internal grounding cable connection

### 4.3.2 Power cables connection

As shown in Figure 4.3.2-1, connect the power ports (BAT+, BAT-) of the inverter to the cascading positive and negative power cables (B+, B-) of the battery module. Connect the remaining battery modules from top to bottom, and secure the cables with cable ties. Ensure that the cables are securely connected.

#### Precautions during installation:



- If the system capacity is greater than 15kWh, the batteries are connected to the inverter's battery input interface in two independent groups.

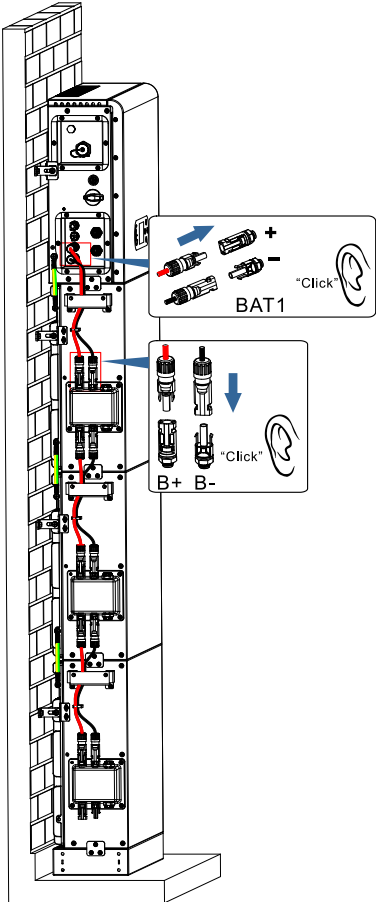

Figure 4.3.2-1 Connection of battery internal DC terminal

**4.3.3 Internal communication cable connection**

Connect the communication terminals of the inverter and battery module from top to bottom according to 4.3.3-1 in the following figure, and secure them with cable ties. For the communication cable, tighten the large nut and then the small nut. In addition, install a matching terminal resistance on the communication interface of the last battery module in the system.

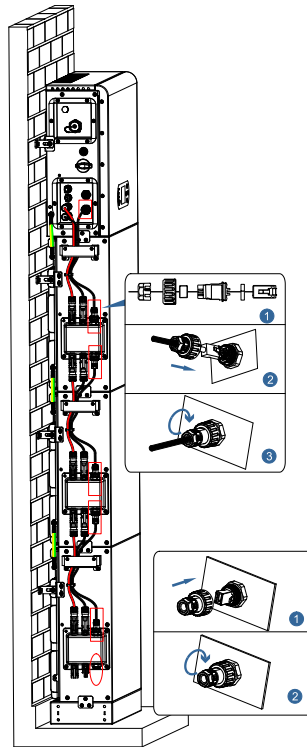
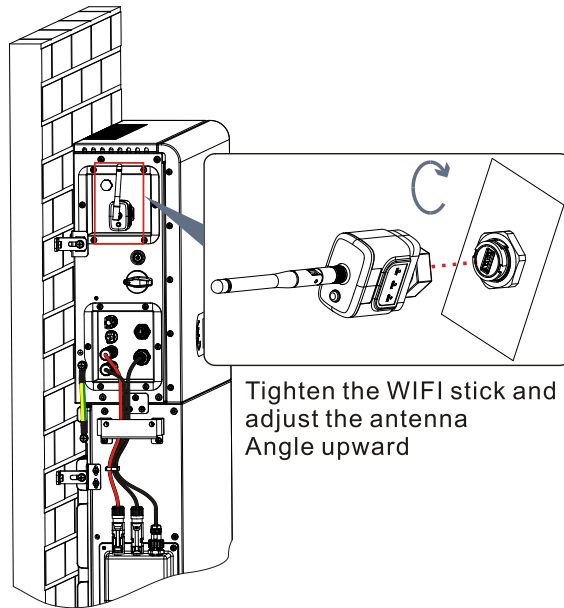

Figure 4.3.3-1 Internal signal cable connection

#### 4.3.4 Data collector connection

Connect the standard WIFI/4G collector in the inverter package according to 4.3.4-1 in the following figure.



Tighten the WIFI stick and  
adjust the antenna  
Angle upward

Figure 4.3.4-1 WIFI/4G connection

### 4.4 External Electrical Connection

#### 4.4.1 External ground Connection of the PGND cable

##### Procedure 1 Crimp OT terminals

Precautions:

- When stripping the cable, do not scratch the core of the cable.
- The conductor crimping plate of an OT terminal is pressed to form a cavity that completely covers the conductor core and tightly binds the

OT terminal.

- The crimping line can be covered with heat shrink tubing or insulation tape.

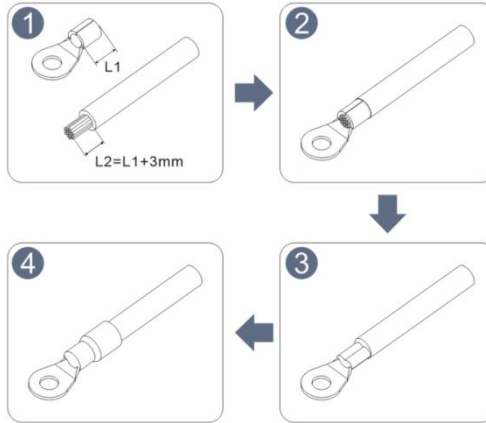

Figure 4.4.1-1 Diagram of Crimping OT terminals

**Procedure 2** The OT terminal is crimped properly, and the ground cable is connected to the position shown in the following figure.

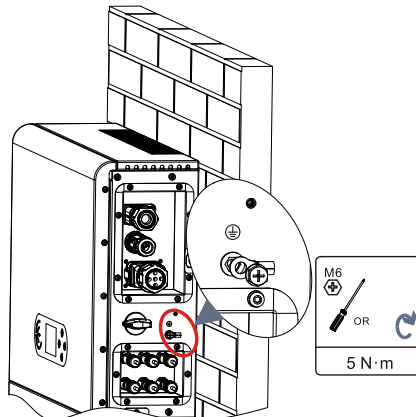

Figure 4.4.4-2 Connect the grounding wire

### 4.4.2 PV module connection

Recommended DC input cable specifications

CAS (mm <sup>2</sup> )		External cable diameter(mm <sup>2</sup> )
Range	Recommended value	
4.0-6.0	4.0	4.5~7.8

**Connection Procedure:**

**Step 1:** Prepare PV positive and negative power cables;

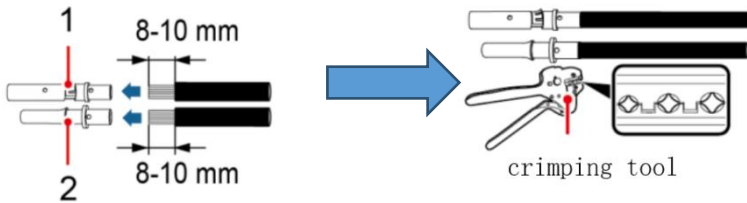
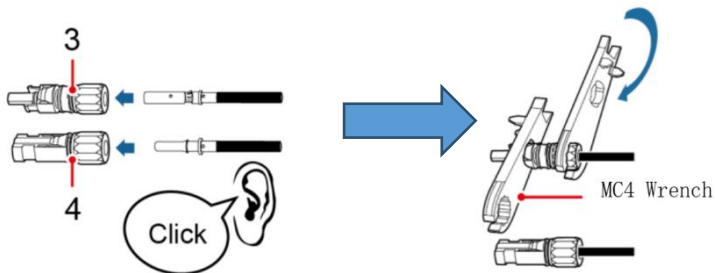

Figure 4.4.2-1 Prepare PV positive and negative power cable

**Step 2:** Insert the crimped photovoltaic positive and negative power cable into the corresponding photovoltaic connector.



3	Positive connector	4	Negative connector
---	--------------------	---	--------------------

Figure 4.4.2-2 Prepare PV positive and negative connectors

**Step 3:** Ensure that the DC voltage of each PV string is less than 600V and the polarity of PV cables are correct. Insert the positive and negative connectors into the corresponding PV region of the ESI series inverter until a click is heard. As the figure 4.4.2-3 showing.

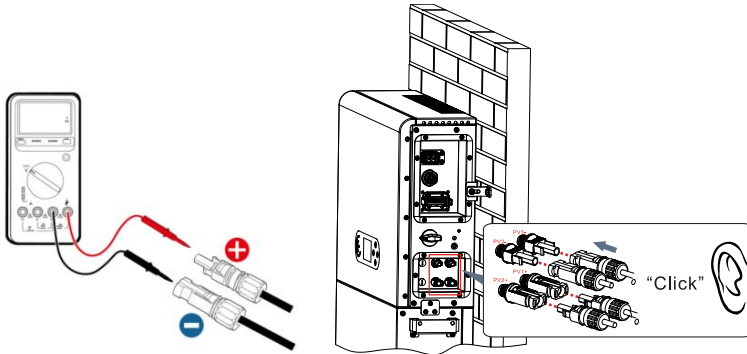

Figure 4.4.2-3 Connect PV connector



Caution

Ensure that the DC switch is turned off before removing the PV positive and negative connectors.

**Follow-up Step**

Disconnect the PV connector using an MC4 wrench, as shown in Figure 4.4.2-4.

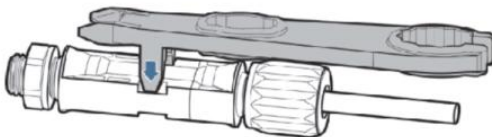

Figure 4.4.2-4 Disconnect PV connectors

### 4.4.3 Grid connection

#### Install AC wiring terminals

Take out AC wiring terminals from the carton of the inverter, strip and install cables according to the cable specifications listed in Table 4.4.3-1.

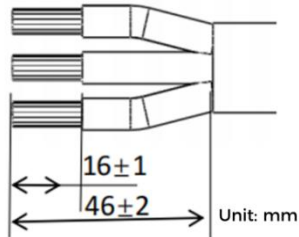
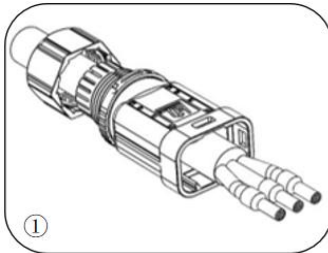
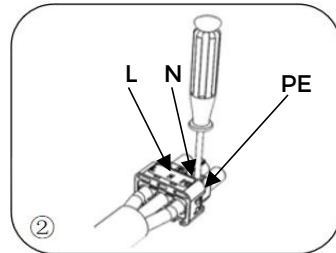

Figure 4.4.3.-1 Wire stripping size

#### Installation Step



After riveting the peeling wire to the insulation terminal, thread it into the lock wire nut and the main body.



Insert the cable into the rubber core according to the wire sequence, make the insulation terminal flush with the surface of the rubber core, and press the screw torque  $2.0 \pm 0.1$  n.m.

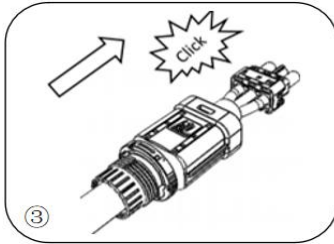

The body is inserted into the core and a click is heard

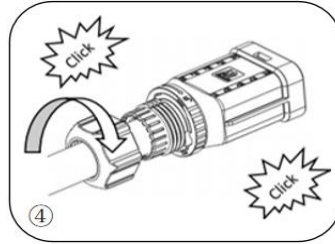

Tighten the nut with an open wrench and make a "click" sound

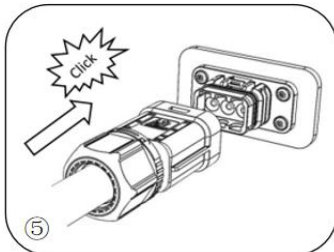

Insert the female end of the wire into the male end and hear a "click" sound.

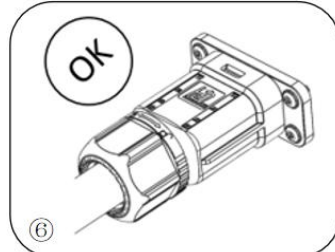

Installation complete

Figure 4.4.3-2 Installation Procedure Diagram

**Removal Step**

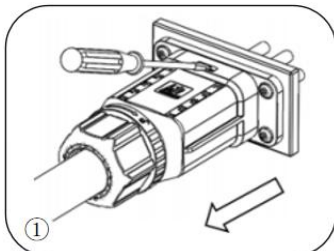

Use a screwdriver to point at the unlocking position, hold the cable driver, and pull it back to separate the male and female.

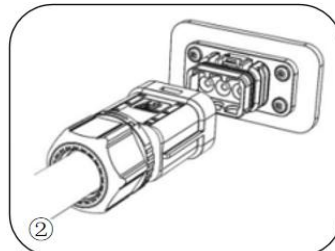

The female connector is separated from the board connector.



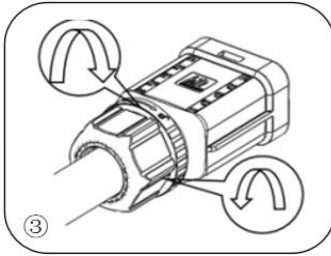

③ Hold the unlocking buckle with one hand and rotate it in the direction indicated, while rotate the nut in the opposite direction with the other hand.

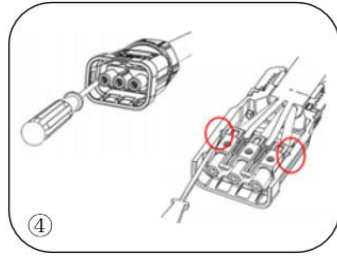

④ Remove the red circles on both sides using a screwdriver.

Figure 4.4.3-3 Removal procedure

Connect the AC wiring terminals to the corresponding AC Grid ports, as shown in the following figure.

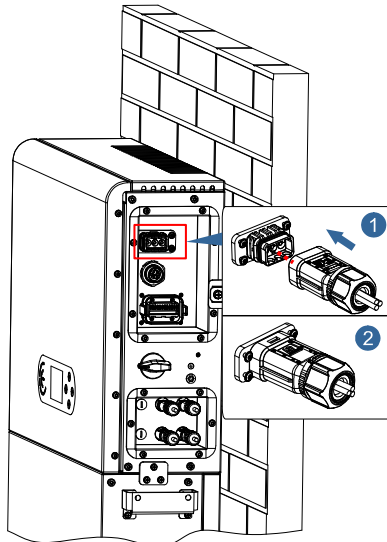

Figure 4.4.3-4 Grid connection

**4.4.4 EPS connection**

According to the cable specifications given in Table 4.2-1, peel the cable according to the following figure 4.4.4-1. Then install the EPS connector according to 4.4.4-2. Finally, insert the installed EPS connector into the corresponding position of the inverter according to Figure 4.4.4-3.

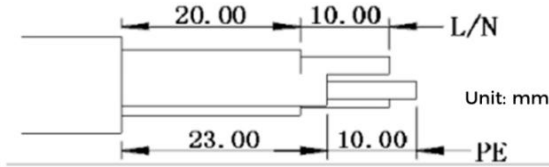
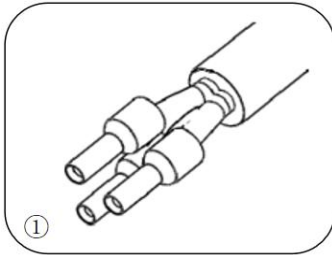
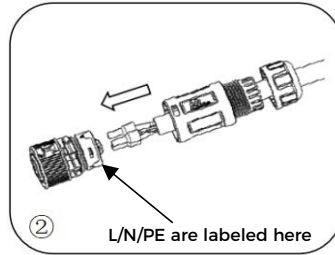

Figure 4.4.4-1 Stripping diagram

**Install procedure**



① Crimp terminal



② Insert the cable into the butt terminal

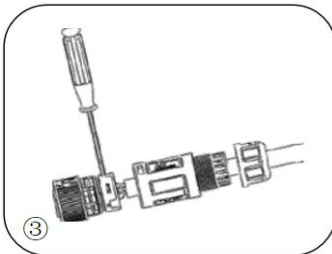

③ Crimp the wire with an inner hexagon screwdriver with a screw torque of  $1.2 \pm 0.1 \text{ n.m}$

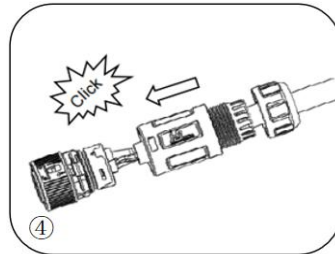

④ Insert the subject into the corresponding clasp and hear a "click" sound

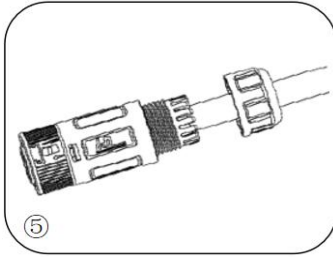

Screw locking nut into main body, torque  $2.5 \pm 0.5 \text{ n.m}$

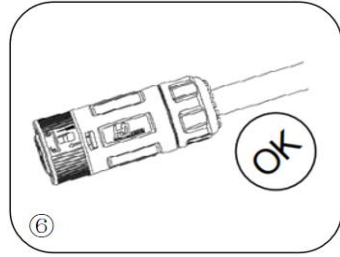

Installation complete

Figure 4.4.4-2 EPS Connector installation

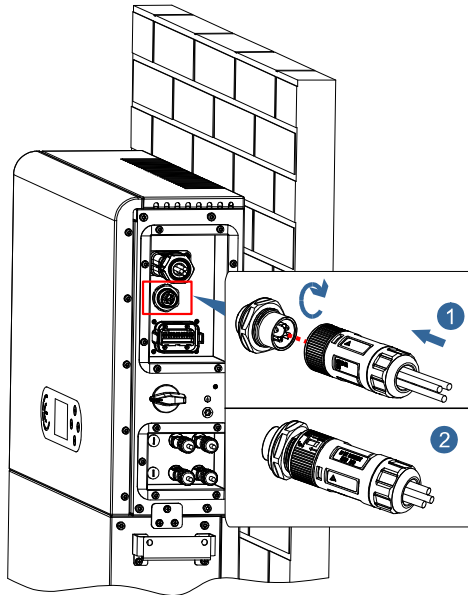

Figure 4.4.4-3 EPS connection



Note

The EPS connector must be connected to the inverter port, even if it is not used.

4.4.5 COM-Multi function communication connection

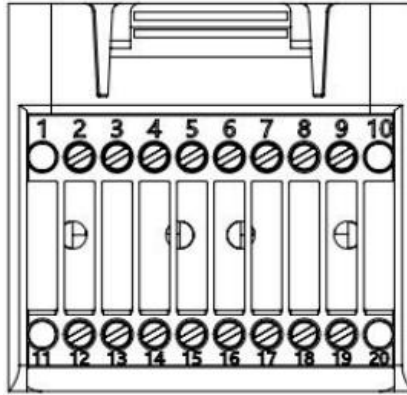

Figure 4.4.5-1 COM port diagram

Table 4.4.5-1 Port description

PIN	Definition	Function	Comment
1	N/A	N/A	
2	UC-A	RS485 differential signal -A	Inverter monitoring 485 signal
3	UC-B	RS485 differential signal -B	
4	EN+	RS485 differential signal +	Battery 485 signal
5	EN-	RS485 differential signal -	
6	MET-A	RS485 differential signal -A	Smart meter 485 signal
7	MET-B	RS485 differential signal -B	
8	CANH	CAN high data	Battery CAN communication signal
9	CANL	CAN low data	
10	N/A	N/A	
11	N/A	N/A	

12	GND	Logic interface signal	( DRMS ) Logical interfaces use for below standard Australia ( AS4777 ) , Europe General ( 50549 ) , German ( 4105 )
13	D1/5		
14	D4/8		
15	D2/6		
16	D0		
17	D3/7		
18	CT+	Current transformer output positive terminal	Current transformer communication signal
19	CT-	Current transformer output negative pole	
20	N/A	N/A	

Link Port

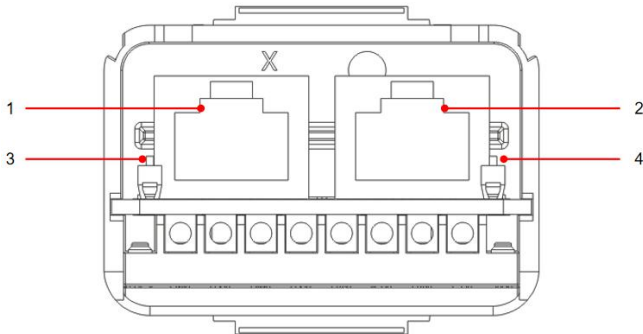

Figure 4.4.5-2 Link Port diagram

Table 4.4.5-2 Link Port description

Icon	Define	Function	Comment
1	Link Port 1	Parallel signal output	Parallel signal port ( RJ45 )
2	Link Port 0	Parallel signal input	
3	Link Port 1 dip switch	Match resistance on and off	The dial switch has ON (dial up) and 1 (dial down). 1 means off.
4	Link Port 0 dip switch		

The wire stripping is divided into 2 to 9 holes and 12 to 19 holes. The wire stripping size is defined according to the cable.

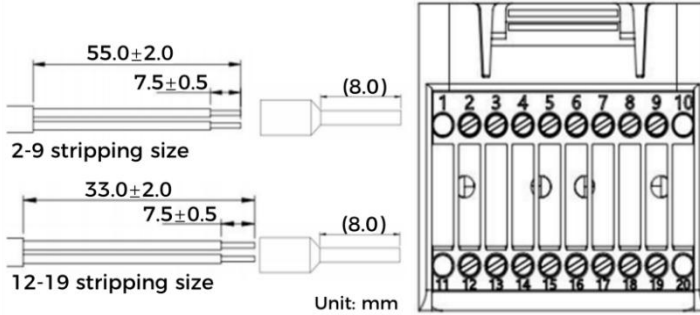



Figure 4.4.5-3 Schematic diagram of wire stripping size

**1. RS485 (Wired monitoring or inverter cascade monitoring)**

Refer to the figure shown below, connect the RS485+ and RS485- of the inverter to the TX+ and TX- of the RS485→ USB adapter, and connect the COM port of the adapter to the computer.

	<p>The length of the RS485 communication cable should be less than 1000 m.</p>
<p>Note</p>	

Connect pins as shown(2pin and 3pin)

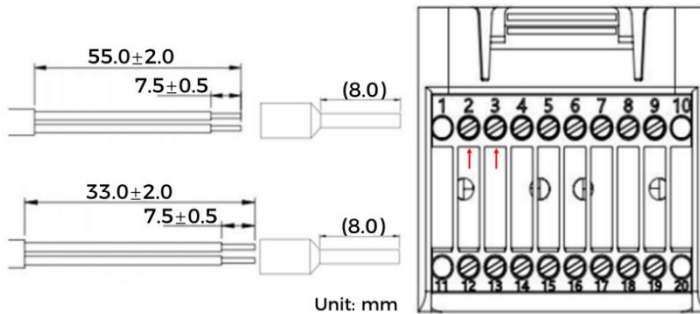



Figure 4.4.5-4 RS485 wiring diagram

RS485 wires are connected in parallel between inverters.

	<p>When multiple inverters are connected via RS485 wires, set communication address to differentiate the inverters, please refer to this manual</p>
<p>Note</p>	<p>&lt;5.4.1 System setting→6.Communication Addr&gt;.</p>

**2. Logic interface**

The logic interface pin definitions and circuit connections are as follows:

Logic interface pin are defined according to different standard requirements

( a ) Logic interface for AS/NZS 4777.2:2020, also known as inverter demand response modes (DRMs).

The inverter will detect and initiate a response to all supported demand response commands within 2 s. The inverter will continue to respond while the mode remains asserted.

Table 4.4.5-3 Function description of the DRMs terminal

Pin NO.	Function
12	GND
13	D1/5
14	D4/8
15	D2/6
16	D0
17	D3/7

( b ) Logic interface for EN50549-1:2019, is in order to cease active power output within five seconds following an instruction being received at the input interface.

The inverter can be connected to a RRCR (Radio Ripple Control Receiver) in order to dynamically limit the output power of all the inverters in the installation.

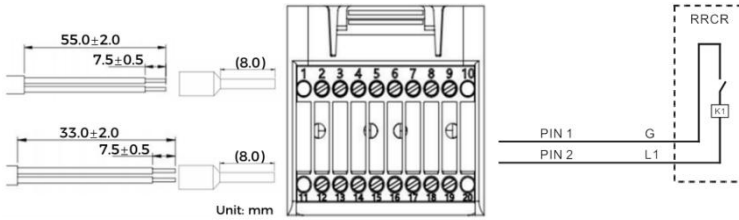

Figure 4.4.5-5 DRMs wiring diagram

Table 4.4.5-4 Function description of the terminal

COM Pin NO.	Pin name	Description	Connected to (RRCR)
PIN 16(PIN2)	L1	Relay contact 1 input	K1 - Relay 1 output
PIN 12(PIN1)	G	GND	K1 - Relay 1 output

Table 4.4.5-5 The inverter is preconfigured to the following RRCCR power levels, close is 1, open is 0

L1	Active Power	Power drop rate	Cos( φ )
1	0%	< 5 seconds	1
0	100%	/	1

**3.Meter/CT**

PIN6 and PIN7 of COM are used for meter communication, the electricity meter is shown in the Figure 4.4.5-6①, PIN6 and PIN7 correspond to 7, 8 respectively on the electricity meter, as shown in Figure 4.4.5-6③.

The connection mode is shown in Figure 4.4.5-6②. The 1/2 and 3/4 on the electricity meter are connected to voltage signals L and N respectively. And the current needs to be connected through the current transformer, 6, 7 correspond to the current transformer.

NOTE: The direction of the current transformer is shown in Figure 4.4.5-6④.



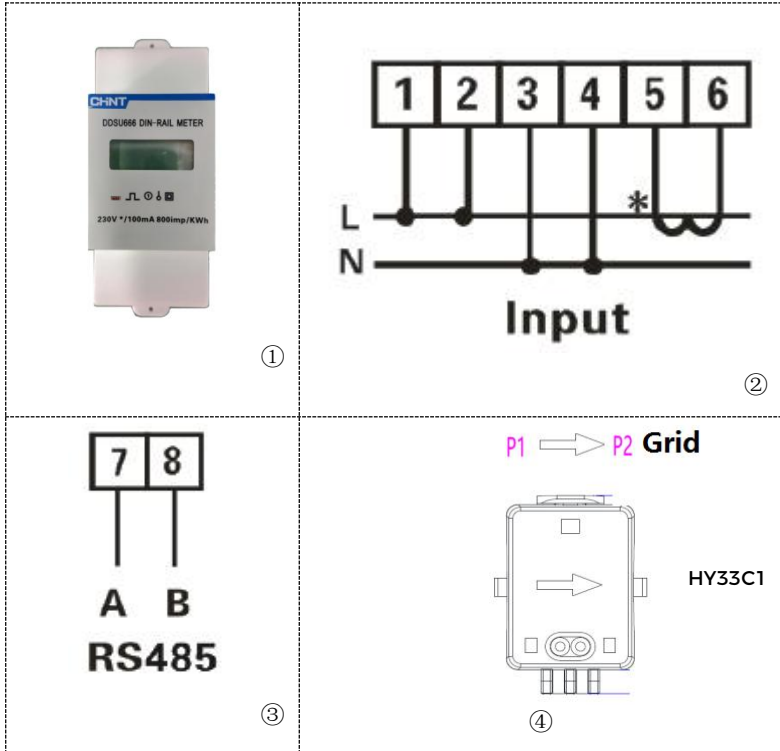

Figure 4.4.5-6 Meter

If you need to use the CT alone, attach the CT to PIN18 and PIN19.

There are two ways to get grid current information:

Plan A: CT (default)      Plan B: Meter +CT

If you need to use the meter +CT scheme, please contact SOFAR staff to purchase the appropriate meter and CT.

COM Installation procedure for connecting cables

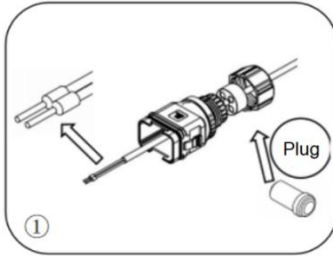

Remove the plug from the plug and thread the terminal in the order shown

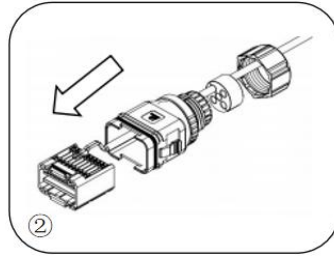

Insert the wire into the corresponding terminal

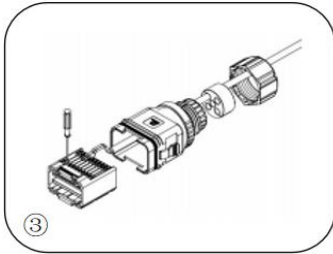

Crimp the wire with a flat-head screwdriver with a torque of  $1.2 \pm 0.1 \text{ n.m}$

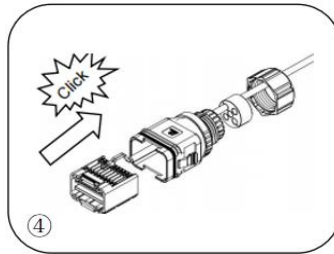

Line core, rubber core area can not appear riding line phenomenon, rubber core into the main body with a "click" sound

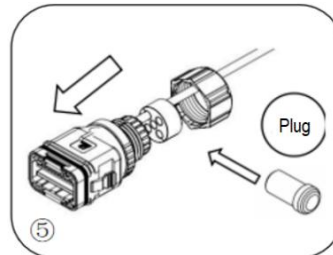

Insert the plug into the body and plug the unwired hole

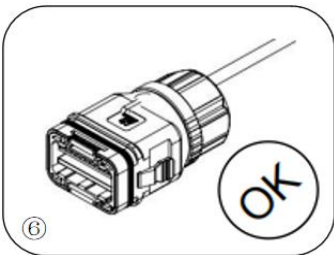

Screw the lock nut into the main body, torque  $2.5 \pm 0.1 \text{ n.m}$ , complete installation

Figure 4.4.5-7 Procedure for connecting COM cables

Insert the stripped COM connector into the corresponding port of the inverter, as shown in the following figure.

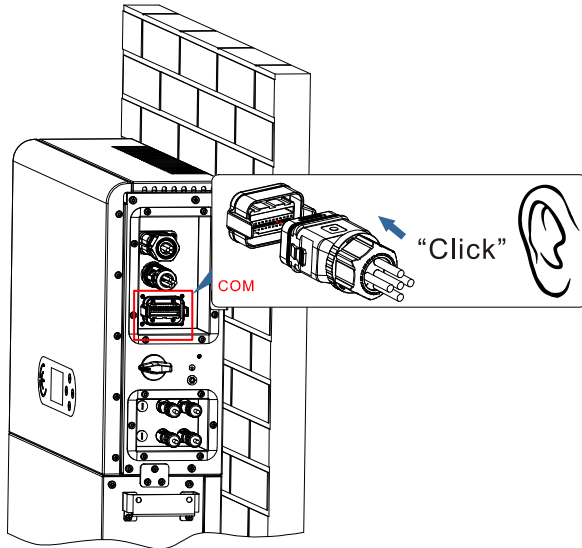

Figure 4.4.5-8 COM connection

#### 4. Feed-in limit function

The feed-in limit function can be used to limit the power fed back into the grid. In order to achieve this function, power measurement devices must be installed according to the system.

Single-phase limit: The power output of the inverter to the power grid does not exceed the set power limit value.

**NOTE:**

1) For the Single-phase limit setting, the current sensor must be properly connected to the L line on the meter. The meter wiring is shown in Figure 4.4.5-6. In addition, refer to 5.3.2(3) for feed-in limit settings.

2) If communication with the smart meter is interrupted, the inverter limits its output power to the set power limit value.

**4.4.6 Smart Meter /CT**

Refer to the COM interface description in Figure 4.4.5-6 Meter, the RS485A and RS485B of the electricity meter should be connected to pin6 and pin7 of the COM port of the inverter.

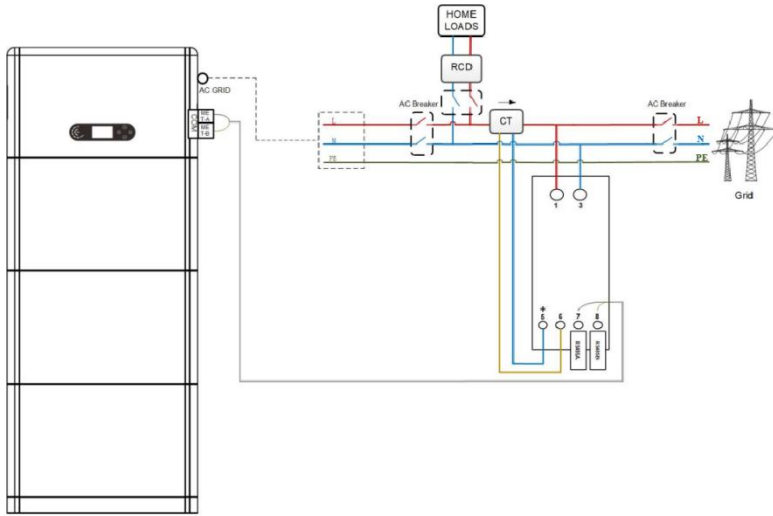

Figure 4.4.6-1 Smart meter/CT connection diagram

**4.5 Install the cover**

After electrical connections are complete and cable connections are correct and reliable, install the external protective cover and secure it using screws.

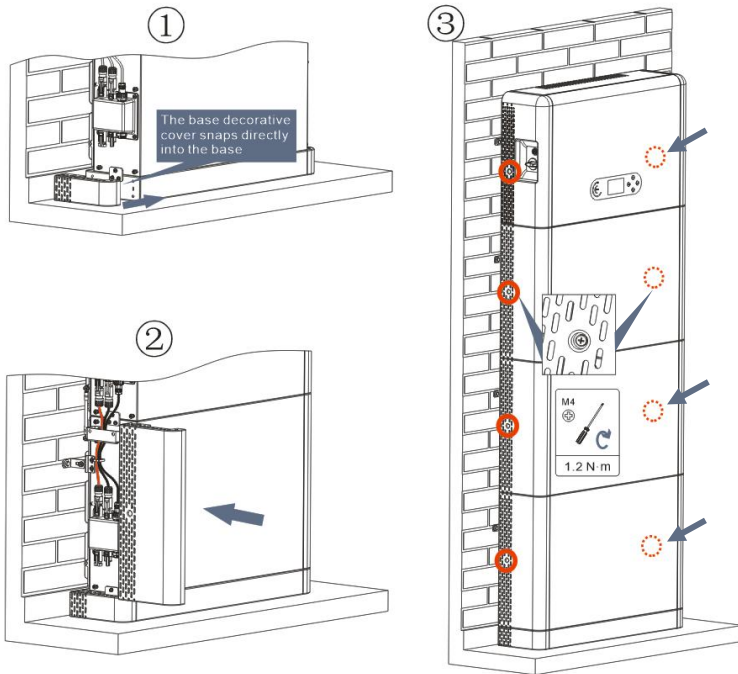

Figure 4.5-1 Install the cover

## 4.6 Parallel system

Refer to figure 4.6-1 below and connect the system in parallel according to the success of the master and slave (up to 6 units). The dip switch inside the COM 24PIN connector of the first and last system inverter should be moved to the position of ON.

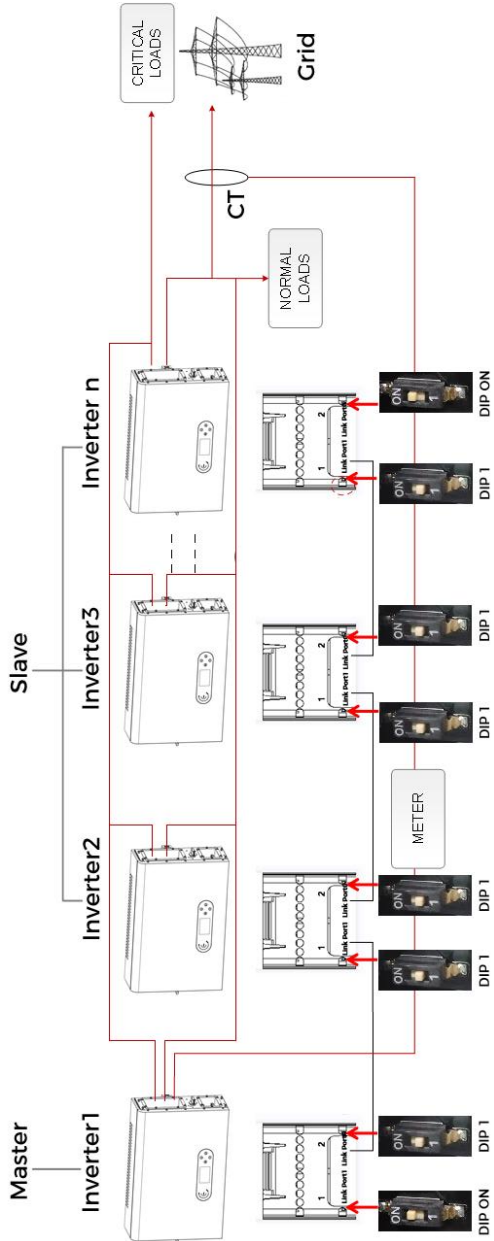

Figure 4.6-1 System parallel diagram

## 4.7 System Electrical Topology

SOFAR has already integrated RCMU (residual current monitoring unit) inside inverter. If an external RCD is required, a type-A RCD with rated residual current of 100mA or higher is suggested.

ESI series household energy storage system is mainly composed of PV modules, BTS 5K battery modules, inverters, AC switches, load and distribution units, smart meters /CT, and power grid.

The inverters AC GRID and AC LOAD are wired with different N and PE wires depending on the regulatory requirements in different regions. For users in Australia, South Africa and New Zealand, please use the System Electrical Topology in Figure 4.7-2.

### System 1: N and PE lines are wired separately in the distribution box

The wiring method in Figure 4.7-1 is applicable to areas without special requirements for distribution system wiring.

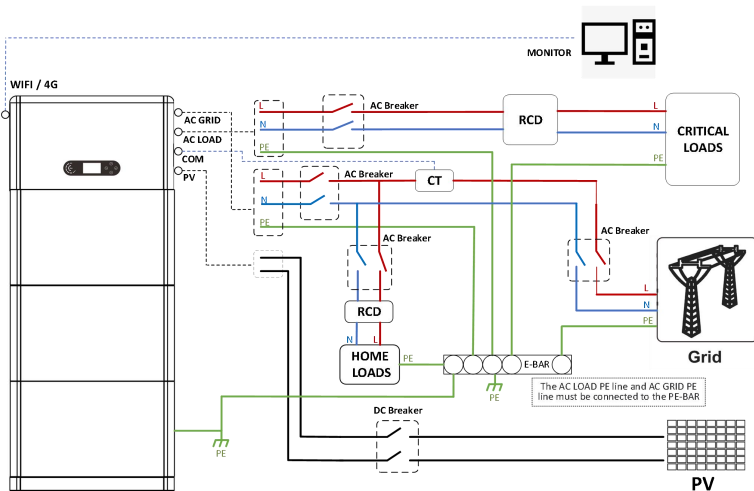

Figure 4.7-1 System Electrical Topology (General)

- a. Ensure that the AC LOAD PE line and AC GRID PE line must be connected to the PE-BAR in the distribution box, as shown in the diagram. Otherwise, the inverter may be abnormal in off-grid mode.
- b. Check whether NeutralPointGrounding is enabled, if not, enable it manually.

2.Advanced setting



Enter 0715

11.NeutralPointGrounding

11. NeutralPointGrounding



Disable

---

Enable

**System 2: N and PE lines are connected together in the distribution box**

The wiring method in Figure 4.7-2 is applicable to areas where N and PE are connected together in the distribution box, such as Australia, South Africa, New Zealand, etc.

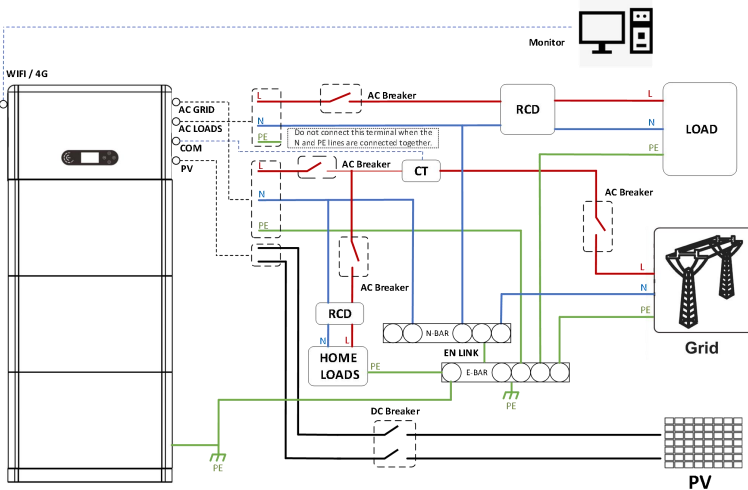







Figure 4.7-2 System Electrical Topology

(For Australia, South Africa and New Zealand)

 Danger	<p><b>Install Residual current device (RCD) in front of the load</b></p> <ul style="list-style-type: none"> <li>● <b>RCD is necessary for critical load, but optional for normal load.</b></li> <li>● In off-grid mode, the Entry master switch is unprotected and load leakage could lead to shock danger.</li> <li>● All RCDs connected to Loads are Type B and its rated earth leakage action current &lt;30mA.</li> </ul>
 Danger	<p><b>Be sure to ensure that the output is grounded</b></p> <p>In system 1, The PE line of the inverter's AC GRID port and AC LOAD port must be grounded through the PE-Bar, otherwise there may be a risk of leakage.</p>
 Note	<p>In system 2, NeutralPointGrounding is disabled by default. No manual setup required.</p>

## 5 Commissioning

### 5.1 Checking Before System Starting

Please double check the following items before running

1. The product should be completely fixed on the pedestal bracket, and the connection with the wall should be tight and firm.
2. The PV+/PV- line is firmly connected, the polarity is correct, and the voltage is in line with the accessible range.
3. BAT+/BAT- cables are firmly connected, the polarity is correct, and the voltage meets the accessible range.
4. Grid/load cable connections are firm/correct.
5. The inverter power grid port is correctly connected to the power grid and the AC circuit breaker is disconnected.
6. The inverter load port is correctly connected to the emergency load, and the circuit breaker is disconnected.

### 5.2 Electrify for the First Time (Important)

Important: Please follow the steps below to turn on the inverter.

1. Ensure that the phase connected to the inverter of the product does not generate power.
2. Switch the DC switch on the PV side of the product to ON.
3. Switch the DC switch on the battery side of the product to ON, and press the battery black start button to activate the battery.
4. Turn on the AC circuit breaker between the inverter power grid port and the power grid.
5. Turn on the AC circuit breaker between the inverter load port and the emergency load.

- Press the system power button, and the inverter starts running. The system status indicator is blue.

When the inverter is running, set the following parameters.

Table 5-1 Setting parameter

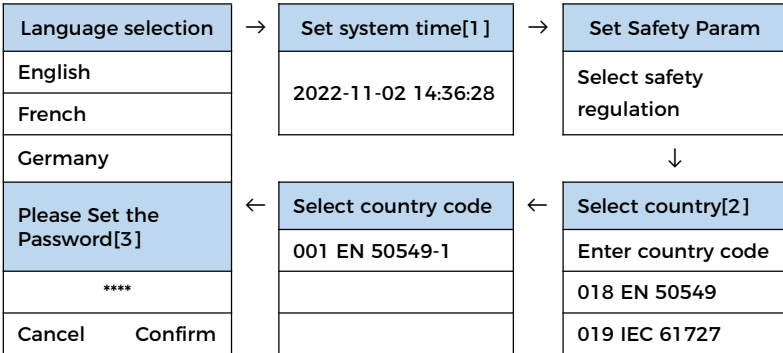

[1] If the collector or mobile APP is connected to the monitoring system, the time has been calibrated to the local time.

[2] Refer to the grid code table below and select country and code.

[3] Appears only when UK grid code is selected.

	<p>If you select the UK grid code, all passwords will be changed to which you set.</p>
<b>Note</b>	

Table 5-2 Safety parameter import

Code	Region	Grid Code	Description
000	000 Germany	VDE-AR-N 4105	Germany low-voltage
001	002 Italia	CEI 0-21 Internal	Italy low-voltage ≤11kVA
		CEI 0-21 External	Italy low-voltage >11kVA
		CEI 0-21 Areti	CEI 0-21 Areti
002	000 Australia	Australia-A	New South Wales, Victoria, Queensland, south Australia, Australian Capital Territory, Jervis Bay Territory
		Australia-B	Western Australia , Northern Territory
		Australia-C	Tasmania
003	002 Spain	NTS 631-BCD	Spain NTS typeB/C/D

	003		UNE 217002 RD647	Spain UNE+RD
	004		Spain island	Spain island
	006		NTS typeA	Spain NTS typeA
004	000	Turkey	EN 50549-1	Turkey
005	000	Denmark	Denmark	Denmark
	001		DK-TR322	DK-TR 322
	002		Western Denmark	Western Denmark
	003		Eastern Denmark	Eastern Denmark
006	000	Greece	GR-Continent	GR-Continent
	001		GR-Island	GR-Island
007	000	Netherland	EN 50549-1	Netherland low-voltage
008	000	Belgium	C10/11	Belgium
	002		Belgium-LV	Belgium-LV
009	000	UK	G99	UK output current > 16A
	001		G98	UK output curren ≤ 16A
	002		G99/NI	Nor Ireland output current > 16A
	003		G98/NI	Nor Ireland output current ≤ 16A
010	000	China	NB/T 32004-B	NB/T 32004-B
	009		NB/T 32004-A	NB/T 32004-A
011	000	France	France	France
	001		FRArrete23	FRArrete23
	003		France VFR 2019	France VFR 2019
	004		VDE 0126 Enedis	VDE 0126 Enedis
	006		VFR 2019 Enedis	VFR 2019 Enedis
	007		EN 50549-1	EN 50549-1
012	000	Poland	Poland-A	Poland-A: ≤ 0.2MW
013	000	Austria	TOR Erzg.-A $\cos\phi$	Austria TOR A < 250kW and nominal voltage < 110kV
	001		TOR Erzg.-A Q-U	Austria TOR A < 250kW and nominal voltage < 110kV
015	000	Switzerland	EN 50549-1	Switzerland-A
018	001	EN 50549	EN 50549-1	EN 50549-1 230V 50Hz
019	000	IEC 61727	IEC 61727	IEC61727 230V 50Hz
021	000	Sweden	Sweden	EN 50549-1
	001		Sweden typeA	Sweden typeA
022	000	User defined-50 Hz	User def.-50 Hz	User defined-50 Hz
024	000	Cyprus	Cyprus	Cyprus
	001		CY-LV-RES	CY-LV-RES
	002		CY-LN/MV-COM	CY-LN/MV-COM
	003		CY-LV/MV-UT	CY-LV/MV-UT
027	000	New Zealand	New Zealand	New Zealand
029	000	Slovakia	SK-VSD	SK-VSD
	001		SK-SSE	SK-SSE
	002		SK-ZSD	SK-ZSD
030	000	Czechia	EN 50549-1	EN 50549-1

	002		PPDS 2023-A1	AC ≤16A,typeA1
	003		PPDS 2023	AC > 16A,typeA2/B/C/D
031	000	Slovenia	SIST EN 50549-1	Slovenia
039	001	Ireland	EN 50549-1	single phase inverter≤6KVA; three phase inverter ≤11KVA
044	000	South Africa	NRS 097-2-1	South Africa-A
123	000	Romania	ANRE 208	Romania
125	000	Finland	EN 50549-1	Finland

	<p>It's very important to make sure that you have selected the correct country code according to requirements of local authority.</p>
<p><b>Caution</b></p>	<p>Please consult qualified electrical engineer or personnel from electrical safety authorities about this.</p> <p>SHENZHEN SOFARSOLAR Co., Ltd. is not responsible for any consequences arising out of incorrect country code selection.</p>

Table 5-3 Default values for other Settings

Item	Default status
Energy Storage Mode	Self-use Mode
EPS Mode	Disable
Set Feed-in Limit	Disable
IV Curve Scan	Disable
Logic Interface	Disable

### 5.3 Steps of Shutdown

Important: Please follow the steps below to turn off the inverter.

1. Close the AC circuit breaker between the inverter grid port and the grid to ensure that the machine is in standby mode;
2. Switch the DC switch on PV side of the product to OFF;
3. Press the battery switch button to turn off the battery output, switch the

DC switch on the battery side of the product to OFF, and the blue indicator light of the system status goes out;

4. Close the AC circuit breaker between the inverter load port and the emergency load.

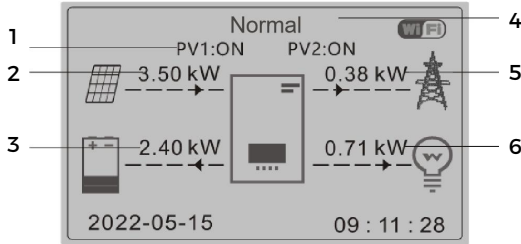

### 5.4 Menu



1	Circulates current PV and battery statue	4	Display current inverter status
2	PV Power	5	Grid Power
3	Battery Power	6	Loads Power

Figure 5-1 Main interface

In the main interface, press “

Main interface		<b>Grid Information</b>
		Grid Voltage.....**.*V Grid Power.....**.*kW Grid Frequency.....**.*Hz Total Load Power.....**.*kW
		<b>Battery Information</b>
		Batt Voltage.....****.V Batt Current.....**.*A Batt Power.....**.*kW Batt Temperature.....*°C

Batt SOC.....	**%
Batt Cycles.....	**T
<b>PV Information</b>	
PV1 Voltage .....	***.V
PV1 Current.....	**.A
PV1 Power.....	** kW
PV2 Voltage .....	***.V
PV2 Current.....	**.A
PV2 Power.....	** kW
PV-Ext Power.....	** kW

In the main interface, press button to enter main menu. The main menu has the following six options.

Main Interface		1.System Settings
		2.Advanced Settings
		3.Energy Statistic
		4.System Information
		5.Event List
		6.Software Update
		7.Battery Real-time Information

### 5.4.1 System Setting

1. System Settings		1.Language Settings
		2.Time
		3.Safety Param.
		4.Energy Storage Mode
		5.Auto Test[1]
		6.EPS Mode
		7.Communication Addr.

[1] Appears only when Italian grid code is selected.

### 1. Language Settings

Used to set the menu display language.

1.Language Settings	⏪	<table border="1"> <tr> <td>1.中文</td> <td>⏩</td> </tr> <tr> <td>2.English</td> <td></td> </tr> <tr> <td>3.Italiano</td> <td></td> </tr> <tr> <td>4.Português</td> <td></td> </tr> <tr> <td>5.Deutsch</td> <td></td> </tr> <tr> <td>6.Čeština</td> <td></td> </tr> <tr> <td>7.Française</td> <td></td> </tr> <tr> <td>8.Español</td> <td></td> </tr> <tr> <td>9.Polski</td> <td></td> </tr> <tr> <td>10.Suomi</td> <td></td> </tr> </table>	1.中文	⏩	2.English		3.Italiano		4.Português		5.Deutsch		6.Čeština		7.Française		8.Español		9.Polski		10.Suomi	
1.中文	⏩																					
2.English																						
3.Italiano																						
4.Português																						
5.Deutsch																						
6.Čeština																						
7.Française																						
8.Español																						
9.Polski																						
10.Suomi																						

### 2. System Time

Set the system time for the inverter.

2.Time	⏪	Time 2022-05-13 17:07:00
--------	---	--------------------------

### 3. Safety Parameter.

3.Safety Param.	⏪	<p><b>Enter 0715</b></p> <table border="1"> <tr> <td>1.Select safety regulations</td> </tr> </table>	1.Select safety regulations
1.Select safety regulations			

Select the correct safety regulations according to the Table 5-2.

### 4. Energy Storage Mode

4.Energy Storage Mode	⏪	<table border="1"> <tr> <td>1.Self-use Mode</td> <td>⏩</td> </tr> <tr> <td>2.Time-of-use Mode</td> <td></td> </tr> </table>	1.Self-use Mode	⏩	2.Time-of-use Mode	
1.Self-use Mode	⏩					
2.Time-of-use Mode						



3. Timing Mode

4. Passive Mode



4.1 Self-use Mode

In Self-use mode, inverter will automatically charge & discharge the battery.

1) If PV power = load power (including emergency load and ordinary load), the inverter will not charge and discharge the battery.

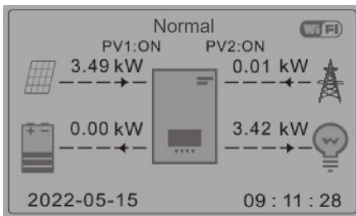

2) If PV generation > LOAD consumption, the surplus power will be stored in the battery.

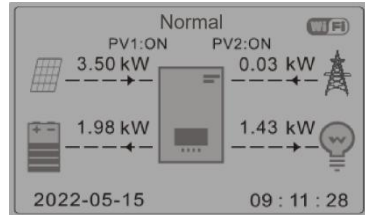

3) If the battery is fully charged or has reached its maximum charging power, the remaining power is sent to the grid (with Feed-in Limitation enabled, the remaining power is not sent to the grid).

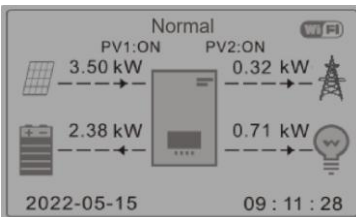

4) If the PV power is less than the load power, the inverter will supply power to the load through battery discharge.

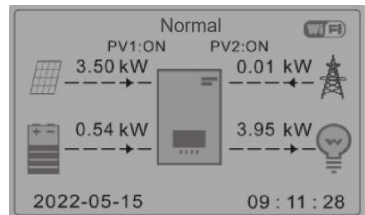

5) If the PV power plus battery power is still less than the load power, the inverter will purchase power from the grid to supply power to the load.

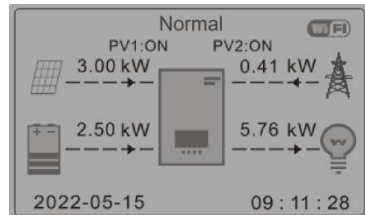

#### 4.2 Time-of-use Mode

If electricity is more expensive in high demand time (peak rate) & electricity is much cheaper in low demand time (off-peak rate). You can select an off-peak period to charge your battery. Outside the off-peak charge period, inverter is working in Auto Mode.

If your family normally go to work/school on weekdays & stay at home on weekends, which means the home electricity consumption is much higher on weekends. Thus, you need to store some cheap electricity on weekends only. This is possible using our Time-of-use mode.

In summer, if your PV system can produce more electricity than your home electricity consumption. Then you don't need to set an off-peak charge period to charge your battery in summer at all. You can select an effective date (normally winter) for Time-of-use mode in this case. Outside the effective date, inverter is working in Auto Mode.

You can set multiple Time-of-use rules to meet your more complex requirement. Right now we support 4 rules maximum (rule 0/1/2/3).

2.Time-of-use Mode



Time-of-use Mode			
Rules. 0: Disabled			
From	To	SOC	Charge
02h00m	-	04h00m	70% 01000W
Effective Date			
Dec. 22	-	Mar. 21	
Weekday select			
Mon. Tue. Wed. Thu. Fri. Sat. Sun.			

#### 4.3 Timing Mode

Changing the value of a rule can set multiple timing rules.

3.Timing Mode		Timing Mode
		Rules: 0: Enabled/Disabled
		Charge Start 22 h 00 m
		Charge End 05 h 00 m
		Charge Power 02000 W
		DisCharge Start 14 h 00m
		DisCharge End 16 h 00m
		DisCharge Power 02500 W

4.4 Passive Mode

4.Passive Mode	
----------------	--

For more detailed information, please ask representative of SOFAR to get a copy of passive mode communication protocol.

5. EPS Mode

5.EPS Mode		1.EPS Mode Control	
<p>1) If PV generation &gt; LOAD consumption(<math>\Delta P &gt; 100W</math>), inverter will charge battery.</p>		<p>2) If PV generation = LOAD consumption(<math>\Delta P &gt; 100W</math>), inverter won't charge or discharge battery.</p>	
<p>3) If PV generation &lt; LOAD consumption(<math>\Delta P &gt; 100W</math>), inverter will discharge battery.</p>			

6. Communication Addr

6.Communication Addr	1.Communication Addr.
	2.Baud Rate

5.4.2 Advanced Setting

2.Advanced setting	<b>Enter 0715</b>
	1.Battery Parameter
	2.Battery Active
	3.Set Feed-in Limit
	4.IV Curve Scan
	5.Logic Interface
	6.Factory Reset
	7.Reset Password[1]
	8.Parallel Settings
	9.Reset Bluetooth
	10.CT Calibration
	11.NeutralPointGrounding
	12.Set PCC Power Offset

[1] Appears only when UK grid code is selected.

1. Battery Parameter

1.Battery Parameter	1.Battery Number
	2.Battery1

Battery Number

Group 1 represents the number of cascading battery modules for the BAT1 port of the inverter.

Group 2 represents the number of battery modules connected to the BAT2

port of the inverter.

Battery 1

2.Battery 1 	1.Depth of Discharge
	2.Enable Force Full Charge
	3.Save

**Depth of Discharge**

For example: if Depth of Discharge = 50% & EPS Depth of Discharge = 80%.

While grid is connected: Inverter won't discharge the battery when its SOC is less than 50%.

In case of blackout: Inverter will work in EPS mode (if EPS mode is enabled) & keep discharging the battery till battery SOC is less than 20%.

3.Depth of Discharge 	Depth of Discharge
	(on-grid)            80%
	Depth of Discharge
	(off-grid)            80%

2. Battery Active

2.Battery Active 	1.Auto Active Control
	2.Force Active

3. Set Feed-in Limit

Users can limit the maximum power sent from the system to the grid by enabling Feed-in Limit. Counter current power is the maximum power expected to be sent to the grid (e.g., 0KW means no energy is fed into the grid).

3.Set Feed-in Limit		1.Feed-in Limit
		2.Hard Limit Control
		3.Feed-in Power
		4.PCC Limit Scheme Config

4.PCC Limit Scheme Config		1.PCC Limit bit
		2.Device type
		3.Current limit percent
		4.Lock enable bit
		5.Reset flag bit
		6.Lock flag bit cleared
		7.Status query

4. IV Curve Scan

When a component of PV modules is blocked or abnormal, multiple power peaks occur, the maximum power peaks can be traced by enabling this function.

The user can enter the scan period to make the inverter scan immediately.

4.IV Curve Scan		1.Scan Control		Enable
		2.Scan Period		Disable
		3.Force Scan		***min



5. Logical Interface

Enables or disables a logical interface. This feature is only available under certain safety regulations.

5.Logical Interface		DRM0:	Enable	
---------------------	--	-------	--------	--

DRMn:	Disable	
-------	---------	---

6. Factory Reset

6.Factory Reset 	1.Clear Energy Data 
	2.Clear Events 
	3.Factory Reset



Clear the total energy yield of the inverter.

1.Clear Energy Data 	Cancel 	<b>Enter 0715</b>
---	--	-------------------

Clear the history events of the inverter.

2.Clear Events 	Cancel 
--	--

7. Reset Password

7.Reset Password 	Please Set the Password
	****
	Cancel <span style="float: right;">Confirm</span>
	
User Password Set to 	****
	Cancel <span style="float: right;">Confirm</span>

8. Parallel Setting

For the parallel system, please refer to <4.6 Parallel System > .

8.Parallel Settings 	1.Parallel control
	2.Set Master/Slave
	3.Set Parallel Address
	4.Save

- 1) Parallel control: Enable or disable the parallel function. This function must be enabled on both the master and slave machines.

- 2) Set master and slave: Set the master and slave. Select one inverter as the master and the others as slave machines.
- 3) Set parallel address: Set the parallel address for each inverter. In a parallel system, each inverter should have a parallel address that does not duplicate that of other machines. (Note: Parallel addresses are different from communications addresses used for monitoring.)
- 4) Save: Be sure to save after the Settings.

9. Reset Bluetooth

9.Reset Bluetooth		Please Confirm!		Succeed
-------------------	--	-----------------	--	---------

10. CT Calibration

Used to calibrate the orientation and phase of the CT. The battery should be charged or discharged when using this feature.

10.CT Calibration		Start CT Calibration?		Succeed/Failed
-------------------	--	-----------------------	--	----------------

11. NeutralPointGrounding

11. NeutralPointGrounding		Disable
		Enable

12. Set PCC Power Offset

12.Set PCC Power Offset		Disable
		Enable

5.4.3 Energy Statistic

3.Energy Statistic		Today
		PV .....**kWh



	Load ..... **kWh
	Export..... **kWh
	Import..... **kWh
	Charge..... **kWh
	Discharge..... **kWh
	<b>Month</b>
	PV ..... **kWh
	Load ..... **kWh
	Export..... **kWh
	Import..... **kWh
	Charge..... **kWh
	Discharge..... **kWh
	<b>Year</b>
	PV ..... **kWh
	Load ..... **kWh
	Export..... **kWh
	Import..... **kWh
	Charge..... **kWh
	Discharge..... **kWh
	<b>Lifetime</b>
	PV ..... **kWh
	Load ..... **kWh
	Export..... **kWh
	Import..... **kWh
	Charge..... **kWh
	Discharge..... **kWh

5.4.4 System Information

4.System Information		1.Inverter Info
		2.Battery Info
		3.Safety Param.
		4.PCU Info
		5.BMS Info

1.Inverter Info		Inverter Info (1)
		Product SN
		Hardware Version
		Power Level
		Inverter Info (2)
		Software Version
		Country
		Safety Lib Version
		Inverter Info (3)
		Energy Storage Mode
		RS485 Address
		Inverter Info (4)
		Logic Interface
		Power Factor
		Inverter Info (5)
	Feed-in Limit	
	Insulation Resistance	

2.Battery Info		Battery 1 Info (1)
----------------	--	--------------------

	Battery Type
	Battery Capacity
	Depth of Discharge
	Battery 1 Info (2)
	Max Charge (A)
	Max Discharge (A)
	Force Full Charge Start
	Force Full Charge End

3.Safety parameters.

	Safety Param.(1)
	OVP 1
	OVP 2
	UVP 1
	UVP 2
	Safety Param. (2)
	OFP 1
	OFP 2
	UFP 1
	UFP 2
	Safety Param.(3)
	OVP 10mins

4.PCU Info

	PCU Info(1)
	PCU serial number
	PCU hardware version

PCU software version

4.BMS Info



BMS Info(1)
BMS serial number
BMS Software Version
Battery Discharge

**5.4.5 Event List**

Once a fault occurs, the fault information is displayed on the event list page. The event list displays the current event records, including the event ID and occurrence time of each event. You can access the event list screen on the main screen to view detailed information about real-time events. Events are listed by occurrence time, and the latest events are listed first.

5.Event List



1.Current event
2.History event



ID042 IsoFault

2.Historical Fault Information



1.ID001 2020-4-3 14:11:45
2.ID005 2020-4-3 11:26:38



1.ID001 Grid OVP
2.ID005 GFCI Fault

**5.4.6 Software Update**

You can upgrade the software using the USB flash drive to maximize the performance of the product and avoid abnormal operation caused by software bugs.

The upgrade file folder name is firmware. These three upgrade file names are HYD3-6K-HV\_ARM\_N2.bin, HYD3-6K-HV\_DSPM\_D0.bin,

HYD3-6K-HV\_DSPS\_N4.bin.

**Step 1** Insert the USB drive into the computer.

**Step 2** SOFAR will send the upgraded firmware to the users who need to upgrade. After receiving the file, decompress it and save it in a USB flash drive.

**Step 3** Insert the USB disk into the USB/WiFi interface of the machine.

**Step 4** Turn on DC switch.

**Step 5**

6.Software Update		<b>Enter 0715</b>
		Update(PCS)
		Update(BMS)
		Update(PCU)
		Update(sofar)
		Update safety package

**Step 6** If the following error occurs, upgrade again. If this situation persists for several times, contact technical support for help.

USB error	DSPM file error	DSPS file error
ARM file error	Upgrading DSPM fail	
Upgrading ARM fail	Upgrading DSPS fail	

**Step 7** After the upgrading, turn off the DC switch, wait for the LCD screen to go off, then restore the WiFi connection, and then turn on the DC switch and AC switch again, and the inverter will enter the running state. You can view the current software version in System Info >> Software Version.

### 5.4.7 Battery real-time Info

7.Battery real-time Info		1.BMS Info
--------------------------	--	------------

2.PCU Info

1.BMS Info



BMS Info (BMS1)	
Batt Voltage.....	****. *V
Batt Current.....	**. **A
Max Charge.....	**. **A
Max Discharge.....	**. **A
Batt SOC.....	**%
Batt SOH.....	**%
Batt Temperature.....	**°C
Batt Cycles.....	**T

2.PCU Info



PCU Info (PCU1)	
PCU low voltage.....	****. *V
PCU high voltage.....	****. *V
PCU low power.....	**. **kW
PCU state.....	****
Internal temp.....	**°C
radiator temp.....	**°C



LCD menu may be modified without notice, please refer to the actually displayed interfaces as final. The latest menu can be downloaded from the official website.

## 5.5 Monitoring description

The operation information (generated energy, alert, operation status) of the inverter can be transferred to PC or uploaded to the server via WiFi(4G is optional). Users can choose to use web or APP for monitoring and viewing according to their needs. You need to register an account and bind the device with the WiFi/4G SN number. The SN number of the WiFi/4G shall be affixed to the package box and the WiFi/4G.

Web: <https://home.solarmanpv.com> (Recommended browser: Chrome58、Firefox49、IE9 and above version)

## 6 Trouble shooting and maintenance

### 6.1 Troubleshooting

- This section describes the potential errors for this product. Please read carefully for the following tips when doing the troubleshooting:
- View the warning or error information and error codes displayed on the display to record all error information
- If no error message is displayed on the LCD, perform the following steps to check whether the current installation status meets the operating requirements of the inverter:
  - Is inverter be installed in a clean, dry, ventilated environment?
  - Is the DC switch turn off?
  - Are the cable cross section area and length meet the requirement?
  - Are the input and output connection and wiring in good condition?
  - Are the configuration settings correctly for the particular installation?
  - Is the display panel properly connected to the communication cable and intact?
- To view the recorded fault information, perform the following steps: On the home screen, press "XXX" to enter the main menu. Select "Events" and press "XXXX" to enter.
- Ground fault alarm

The integrated inverters in this product comply with the ground fault alarm monitoring of IEC 62109-2 clause 13.9. If a grounding fault alarm occurs, the fault will be displayed on the LCD screen with red light on, and the fault can also be found in the fault history. For the machine equipped



with WiFi/4G data collector, the alarm information can be seen on the corresponding monitoring website or received through the APP on the mobile phone.

- List of common events
- Table 6-1 List of common events

ID No.	Name	Description	Solution
ID001	Grid overvoltage	The grid voltage is too high	If the alarm occurs occasionally, the possible cause is that the electric grid is abnormal occasionally. Inverter will automatically return to normal operating status when the electric grid's back to normal. If the alarm occurs frequently, check whether the grid voltage/frequency is within the acceptable range. If yes, please check the AC circuit breaker and AC wiring of the inverter. If the grid voltage/frequency is NOT within the acceptable range and AC wiring is correct, but the alarm occurs repeatedly, contact SOFAR technical support to change the grid over-voltage, under- voltage, over-frequency, under-frequency protection points after obtaining approval from the local electrical grid operator.
ID002	Grid undervolt	The grid voltage is too low	
ID003	Grid overfreq	The grid frequency is too high	
ID004	Grid underfreq	The grid frequency is too low	
ID005	GFCI Fault	Charge Leakage Fault	Internal faults of inverter. Switch OFF inverter, wait for 5 minutes, then switch ON inverter. Check whether the problem is solved. If not, please contact SOFAR technical support.
ID008	IslandFault	Island protection error	
ID009	GridOVP Instant1	Transient overvoltage of grid voltage	
ID012	InvOVP	Inverter voltage error	
ID013	Reflux OverLoad	Feed-in Limit function is faulty	

ID032	N-PE fault	Neutral ground fault	
ID042	IsoFault	Low insulation impedance	Check the insulation resistance between the photovoltaic array and ground (ground), if there is a short circuit, the fault should be repaired in time. If not solved, please contact SOFAR technical support.
ID043	PEConnect Fault	Ground fault	Check ac output PE wire for grounding.
ID045	CT Disconnect	CT Disconnected	Check whether the CT connection is correct
ID046	Reversal Connect	Input reverse connection error	Check whether the DC input connection is correct
ID047	Parallel Fault	Parallel Fault	Check whether parallel is enabled. Check whether parallel addresses overlap. Check whether the parallel network is connected properly.
ID049	Temp Fault_Bat	Battery temperature protection	Make sure the inverter is installed in a place free from direct sunlight.
ID050	TemFault Radiat1	Radiator temperature protection	Make sure the inverter is installed in a cool/well-ventilated place.
ID057	TemFault Env1	Ambient temperature protection	Ensure that the inverter is installed vertically and the ambient temperature is lower than the upper limit of the inverter temperature.
ID059	TemFault Inv1	Module temperature protection	
ID065	VbusRms Unbalan	Unbalanced bus voltage RMS	Internal faults of inverter. Switch OFF inverter, wait for 5 minutes, then switch ON inverter. Check whether the problem is solved. If not, please contact SOFAR technical support.
ID066	VbusInst Unbalan	The transient value of bus voltage is unbalanced	
ID067	BusUVP	Bus undervoltage during grid connection	
ID068	BusZVP	Bus voltage low	
ID069	PVOVP	PV over-voltage	Check whether the PV series voltage (Voc) is higher than the maximum input voltage of the inverter. If yes, adjust the number of PV modules in

			series and reduce the PV string voltage to fit the input voltage range of the inverter. After correction, the inverter will automatically return to normal state.
ID070	BatOVP	Bat over-voltage	Check whether the battery overvoltage Settings are inconsistent with battery specifications
ID072	SwBus RmsOVP	Inverter bus voltage RMS software overvoltage	Internal faults of inverter. Switch OFF inverter, wait for 5 minutes, then switch ON inverter. Check whether the problem is solved. If not, please contact SOFAR technical support.
ID073	SwBus InstantOVP	Inverter bus voltage instantaneous value software overvoltage	
ID081	SwBat OCP	Battery overcurrent protection by software	
ID082	DciOCP	Dci overcurrent protection	
ID083	SwOCP Instant	Output instantaneous current protection	
ID084	SwBuck BoostOCP	BuckBoost software overcurrent	
ID085	SwAc RmsOCP	The output RMS overcurrent	
ID086	SwPvOCP Instant	PV overcurrent software protection	
ID087	Ipv Unbalance	PV flows in uneven parallel	
ID088	Iac Unbalance	Unbalanced output current	
ID098	HwBusOVP	Inverter bus hardware overvoltage	
ID099	HwBuck BoostOCP	BuckBoost hardware overcurrent	
ID100	HwBatOCP	Battery hardware overcurrent	
ID102	HwPV OCP	PV hardware	

		overcurrent	
ID103	HwACOCP	Ac output hardware overcurrent	
ID105	Meter Comm Lose	Meters communication fault	Check whether the meter is enabled. Check whether the meter wiring is correct
ID110	Overload1	Overload Protection	Check whether the load power is greater than the inverter output power
ID113	OverTem Derate	Overtemperature derating	Make sure the inverter is installed in a place free from direct sunlight. Make sure the inverter is installed in a cool/well-ventilated place. Ensure that the inverter is installed vertically and the ambient temperature is lower than the upper limit of the inverter temperature.
ID114	Freq Derating	Frequency derating	Make sure the grid frequency and voltage are within acceptable range.
ID116	Volt Derating	Voltage derating	
ID124	LowBattery	Battery Low	Check whether the battery voltage is too low or the battery depth of discharge is too low.
ID125	Bat Discharge Prohibited	Battery Discharge Prohibit	
ID129	HwAcOCP	Output hardware overcurrent permanent fault	Internal faults of inverter. Switch OFF inverter, wait for 5 minutes, then switch ON inverter. Check whether the problem is solved. If not, please contact SOFAR technical support.
ID130	BusOVP	Bus overvoltage permanent fault	
ID131	HwBusOVP	Bus hardware overvoltage permanent fault	
ID132	Ipv Unbalance	PV unbalance current permanent fault	
ID133	EPSBatOCP	EPS mode battery overcurrent	

ID134	AcOCP Instant	Output transient overcurrent permanent fault	
ID135	Iac Unbalance	Output current imbalance permanent fault	
ID138	PVOCP Instant	Input overcurrent permanent fault	
ID139	HwPVOCP	Input hardware overcurrent permanent fault	
ID140	RelayFail	Relay permanent fault	
ID141	Vbus Unbalance	Bus unbalance permanent fault	
ID142	SpdFail(DC)	DC SPD fault	
ID145	USBFault	USB fault	Check the USB port of the inverter.
ID152	SafetyVer Fault	Safety parameter version error	Please contact SOFAR technical support.
ID153	SciLose(DC)	SCI communication error (DC)	
ID154	SciLose(AC)	SCI communication error (AC)	
ID156	SoftVer Error	Inconsistent software versions	Contact technical support to obtain the upgrade software.
ID157	BMS1 Comm Fault	Lithium battery communication error	Make sure the battery you use is compatible with the inverter. CAN communication is recommended. Check whether the communication cable or port between the battery and the inverter is faulty.
ID162	Remote Shutdown	Remote shutdown	The inverter is shut down remotely.
ID163	Drms0 Shutdown	Drms0 shutdown	The inverter is Drms0 shut down.
ID177	BMS OVP	BMS over-voltage alarm	The lithium battery is faulty. Shut down the inverter and lithium

			battery. Wait for 5 minutes and start the inverter and lithium battery. Check whether the problem is rectified. If not, contact technical support.
ID178	BMS UVP	BMS under-voltage alarm	Please make sure the battery is installed in a cool well-ventilated place. If The battery is installed correctly, please contact technical support.
ID179	BMS OTP	BMS high temperature alarm	
ID180	BMS UTP	BMS low temperature alarm	
ID181	BMS OCP	BMS charge and discharge overcurrent	Power off and wait for 2 hours. If the problem is not solved, please contact technical support.
ID182	BMS Short	BMS Short circuit alarm	
ID808	HS1 HighTemp Warning	Radiator 1 high temperature alarm	Please make sure the battery is installed in a cool well-ventilated place. If The battery is installed correctly, please contact technical support.
ID809	Env HighTemp Warning	Ambient high temperature alarm	
ID813	StopChg Warning	Charging prohibition alarm	If the battery is almost fully, no action is required. Otherwise, please contact technical support.
ID814	StopDchg Warning	Discharging prohibition alarm	If the battery is almost empty, no action is required. Otherwise, please contact technical support.
ID864	HS1 OverTemp Fault	Over temperature protection of radiator 1	Power off and wait for 2 hours. If the problem is not solved, please contact technical support.
ID865	OverTemp Fault_Env	Over temperature protection of ambient temperature	
ID867	Can1Com mFault	Can1 communication failure	If this fault occurs occasionally, wait a few minutes to see whether the problem is solved. If this fault occurs frequently, please contact technical
ID872	SwBus InstantOVP	Bus software overvoltage	

ID873	SwBus InstantUVP	Bus software undervoltage	support.
ID874	SwBat InstantOVP	Battery software overvoltage	
ID875	SwBat InstantUVP	Battery software undervoltage	
ID876	SwBat InstantOCP	Battery software overcurrent	
ID879	HwOCP	Hardware overcurrent	Restart the battery and wait for minutes. If the problem is not resolved, please contact technical support.
ID880	Unrecover BusAvgOV	Permanent bus overvoltage	
ID881	Unrecover BatAvgUV	Permanent battery undervoltage	Check whether the wiring is correct and restart the battery. If the problem is not resolved, please contact technical support.
ID882	Unrecover OCPIstant	Permanent Instant overcurrent	
ID883	Unrecover HwOCP	Permanent hardware overcurrent	
ID894	Unrecover BatActFail	Permanent battery activation failed	
ID895	Unrecover BusRPP	Permanent bus reverse connection	
ID899	BMS OVOCP	BMS overvoltage and overcurrent fault	If this fault occurs occasionally, wait a few minutes to see whether the problem is solved. If this fault occurs frequently, please contact technical support.
ID900	SwBat AvgOCP	Battery average overcurrent protection	
ID901	SwAvg OverloadP	Average overload protection	
ID903	SwCBCOCP	Software CBC overcurrent protection	

	<ul style="list-style-type: none"> <li>●This table only shows part of the events, please go to our website for details.</li> <li>●The events whose ID number over 800 are related to the battery module BTS 5K.</li> </ul>
	<p><b>Note</b></p>

## 6.2 Daily Maintenance

This product usually does not require maintenance or calibration, but ensure that the inverter and the heat sink of the battery module are not covered by dust or dirt.

- Clean the inverter and battery modules:

Please clean the inverter with an air blower, a dry & soft cloth or a soft bristle brush. Do NOT clean the inverter with water, corrosive chemicals, detergent, etc.

- Clean radiator:

In order to ensure the normal function and long service life of the product, it is necessary to ensure that there is enough air flow space around the radiator at the rear of the product, and there is no material around the radiator that obstructs the air flow, such as dust or snow, must be removed. Clean the radiator with compressed air, a soft cloth, or a soft brush. Do not use water, corrosive chemicals, cleaning agents, or strong detergents to clean the heat sink.



## 7 Datasheet

	The following parameters may change without notice, please refer to the user manual and DataSheet on our website.						
<b>Note</b>							
<b>Model</b>	ESI 3K-S1	ESI 3.68K- S1	ESI 4K-S1	ESI 4.6K- S1	ESI 5K-S1	ESI 5K-S1 -A	ESI 6K-S1
<b>PV Input</b>							
Recommended Max. PV Power	4500 Wp	5400 Wp	6000 Wp	6900 Wp	7500 Wp	7500 Wp	9000 Wp
Max. input voltage	550 Vd.c.						
Start-up Voltage[1]	100 Vd.c.						
Rated Input Voltage	360 Vd.c.						
MPPT Voltage Range	85-520 Vd.c.						
Number of MPPT	2						
Max. Number of Input Strings per MPPT	1/1						
Max. Input Current	16/16 A						
Max. Isc	22.5/22.5 A						
<b>Battery</b>							
Voltage Range	350-435 Vd.c.						
Number of Battery Input Channels	2						
Max. Charging/ Discharging Power	3 kW	3.68 kW	4 kW	4.6 kW	5 kW	5 kW	6 kW
Max. Charging/ Discharging Current	20 A						
Battery Type[2]	Lithium-ion						

BMS Communication	CAN						
<b>AC Input(Grid)</b>							
Rated Input Voltage	L+N+PE,220/230/240 Va.c.						
Rated Input Frequency	50/60 Hz						
Max. Input Current	27.3/ 26.1/ 25.0 A	33.5/ 32.0/ 30.7 A	36.4/ 34.8/ 33.3 A	41.8/ 40.0/ 38.3 A	45.5/ 43.5/ 41.7 A	45.5/ 43.5/ 41.7 A	54.5/ 52.2/ 50.0 A
<b>AC Output(Backup)</b>							
Rated Output Voltage	L+N+PE,220/230/240 Va.c.						
Rated Output Frequency	50/60 Hz						
Rated Output Power	3 kW	3.68 kW	4 kW	4.6 kW	5 kW	5 kW	6 kW
Rated Output Current	13.6/ 13.0/ 12.5 A	16.7/ 16.0/ 15.3 A	18.2/ 17.4/ 16.7 A	20.9/ 20.0/ 19.2 A	22.7/ 21.7/ 20.8 A	22.7/ 21.7/ 20.8 A	27.3/ 26.1/ 25.0 A
Rated Apparent Power	3 kVA	3.68 kVA	4 kVA	4.6 kVA	5 kVA	5 kVA	6 kVA
Max. Output Current	13.6/ 13.0/ 12.5 A	16.7/ 16.0/ 15.3 A	18.2/ 17.4/ 16.7 A	20.9/ 20.0/ 19.2 A	22.7/ 21.7/ 20.8 A	22.7/ 21.7/ 20.8 A	27.3/ 26.1/ 25.0 A
Max. Apparent Power	3 kVA	3.68 kVA	4 kVA	4.6 kVA	5 kVA	5 kVA	6 kVA
Peak Output Apparent Power	4.5 kVA, 60s	5.52 kVA, 60s	6 kVA, 60s	6.9 kVA, 60s	7.5 kVA, 60s	7.5 kVA, 60s	9 kVA, 60s
THDv(@ linear load)	<3%						
Switching Time	10 ms default						
<b>AC Output(Grid)</b>							
Rated Output Voltage	L+N+PE,220/230/240 Va.c.						
Rated Output Frequency	50/60 Hz						

Rated Output Power	3 kW	3.68 kW	4 kW	4.6 kW	5 kW	5 kW	6 kW
Rated Output Current	13.6/13.0/12.5 A	16.7/16.0/15.3 A	18.2/17.4/16.7 A	20.9/20.0/19.2 A	22.7/21.7/20.8 A	22.7/21.7/20.8 A	27.3/26.1/25.0 A
Max. Apparent Power	3.3 kVA	3.68 kVA	4.4 kVA	4.6 kVA	5.5 kVA	5 kVA	6.6 kVA
Max. Output Current	15.0/14.3/13.8 A	16.7/16.0/15.3 A	20.0/19.1/18.3 A	20.9/20.0/19.2 A	25.0/23.9/22.9 A	22.7/21.7/20.8 A	30.0/28.7/27.5 A
THDi	<3%						
Power Factor Range	0.8 lagging-0.8 leading						
<b>Efficiency</b>							
Max. MPPT Efficiency	99.9%						
Max. Efficiency	97.7%	97.7%	97.7%	97.8%	97.8%	97.8%	97.8%
European Efficiency	97.0%	97.0%	97.0%	97.1%	97.1%	97.1%	97.1%
Max. Efficiency of Charging/ Discharging[3]	97%						
<b>Protection</b>							
DC Switch	Yes						
PV Reverse Connection Protection	Yes						
Battery Reverse Connection Protection	Yes						
Output Short Circuit Protection	Yes						
Output Overcurrent Protection	Yes						
Output Overvoltage Protection	Yes						

Insulation Impedance Detection	Yes
Residual Current Detection	Yes
Anti-island Protection	Yes
Surge Protection	PV:Type II, AC:Type II
<b>General Parameter</b>	
Inverter Topology	Non-Isolation
Protective Class	Class I
IP Rating	IP65
Overvoltage Category	AC III, DC II
Operating Temperature Range	-10°C to +50°C (derating above +45°C)
Relative Humidity Range	5%-95%
Max. Operating Altitude	4000 m (derating above 2000 m)
Standby Self-consumption [4]	<10 W
Dimensions(W*H*D)	708*410*170 mm
Cooling Mode	Natural
Weight	Approx. 26 kg
Communication	CAN/RS485/WiFi,Optional:4C/LAN
Display	LCD & APP

[1] Minimum PV voltage to start MPPT operation.

[2] Please refer to document “SOFAR inverter Model compatible battery list”.

[3] Battery-AC maximum efficiency of battery charge and discharge.

[4] Standby loss at rated input voltage.

## 8 Manufacturer's Warranty and Liability Terms

### **SOFAR standard warranty document**

Warranty period and calculation method of SOFAR battery products refer to the Quality Assurance Agreement of SOFAR ESI Series Household Energy Storage System.

### **Extended warranty period**

If the purchased battery exceeds the warranty period stipulated in the Warranty Agreement of SOFAR ESI Series Household Energy Storage System, the customer can apply for the extended warranty period by providing the serial number of the product to the sales team of the company, and the Company has the right to reject the purchase application for the extended warranty period that does not meet the requirements.

If the original buyer wants to apply for the extended warranty service, please contact the sales team of SHENZHEN SOFARSOLAR Co., LTD to purchase the products that exceed the extended warranty period but have not passed the warranty period stipulated in the Warranty Agreement of SOFAR ESI Series Household Energy Storage System, the original buyer shall bear different extended premiums.

Upon purchase of the extended warranty service, our company will issue an extended warranty card to the customer to confirm the extended warranty period.

### **Invalid warranty clause**

Equipment failure caused by the following reasons is not covered by the warranty:

- 1) The "warranty card" has not been sent to the distributor or Shenzhen SOFARSOLAR Co., LTD;
- 2) Without the consent of SHENZHEN SOFARSOLAR Co., LTD to change equipment or replace parts;
- 3) Use unqualified materials to support SHENZHEN SOFARSOLAR Co., LTD 's products, resulting in product failure;
- 4) Technicians who don't belong to SOFARSOLAR Co., LTD modify or attempt to repair and erase the product serial number or silk screen;
- 5) Incorrect installation, debugging and use methods;
- 6) Failure to comply with safety regulations (certification standards, etc.);
- 7) Damage caused by improper storage by dealers or end users;
- 8) Transportation damage (including scratches caused by internal packaging during transportation). Please claim directly from the transportation company or insurance company as soon as possible and obtain damage identification such as container/package unloading;
- 9) Failure to follow the product user manual, installation manual and maintenance guidelines;
- 10) Improper use or misuse of the device;
- 11) Poor ventilation of the device;
- 12) The product maintenance process does not follow relevant standards;
- 13) Failure or damage caused by natural disasters or other force (such as earthquake, lightning strike, fire, etc).

Version 4.1



ENERGY TO POWER YOUR LIFE

**ADDRESS**

11/F., Gaixinqi Technology Building,  
Xingdong Community, Xin'an Sub-district,  
Bao'an District, Shenzhen City, China

**EMAIL**

[info@sofarsolar.com](mailto:info@sofarsolar.com)

**WEBSITE**

[www.sofarsolar.com](http://www.sofarsolar.com)

