

SCALA

Installation and operating instructions



English (GB) Installation and operating instructions

Original installation and operating instructions.

These installation and operating instructions describe Grundfos SCALA domestic water supply pumps.

Sections 1-4 give the information necessary to be able to unpack, install and start up the product in a safe way.

Sections 5-14 give important information about the product, as well as information on service, fault finding and disposal of the product.

CONTENTS

	Page
1. General information	2
1.1 Target group	2
1.2 Symbols used in this document	2
2. Receiving the product	2
2.1 Inspecting the product	2
2.2 Scope of delivery	2
3. Installing the product	3
3.1 Location	3
3.2 System sizing	3
3.3 Mechanical installation	3
3.4 Foundation	3
3.5 Installation examples	4
3.6 Suction pipe length	5
3.7 Electrical connection	5
4. Starting up the product	5
4.1 Priming the pump	5
4.2 Starting the pump	5
4.3 Shaft seal run-in	6
5. Storing and handling the product	6
5.1 Handling	6
5.2 Storing	6
5.3 Winterizing	6
6. Product introduction	6
6.1 Product description	6
6.2 Application	6
6.3 Pumped liquids	6
6.4 Identification	7
7. Control functions	8
7.1 Menu overview, SCALA2	8
8. Operating the controller	9
8.1 Setting the outlet pressure	9
8.2 Locking and unlocking the operating panel	9
8.3 Expert settings, SCALA2	9
8.4 Resetting to factory settings	9
9. Starting up the product after shutdown or standstill	9
9.1 Deblocking the pump	9
9.2 Controller settings	9
9.3 Priming	9
10. Servicing the product	10
10.1 Maintaining the product	10
10.2 Customer service information	10
10.3 Service kits	10
11. Taking out of operation	10
12. Fault finding the product	11
12.1 Grundfos Eye operating indications	11
12.2 Fault resetting	11
12.3 Fault finding chart	12
13. Technical data	14
13.1 Operating conditions	14
13.2 Mechanical data	14
13.3 Electrical data	14
14. Disposal	14



Warning

Prior to installation, read this document and the quick guide. Installation and operation must comply with local regulations and accepted codes of good practice.

Warning

This product can be used by children of eight years and up and persons with reduced physical, sensory or mental capabilities or lack of experience and knowledge if they are under supervision or have been instructed in the safe use of the product and understand the hazards involved.

Children must not play with the product.

Cleaning and maintenance of the product must not be made by children without supervision.

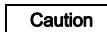

This pump has been evaluated for use with water only.

Warning

Risk of electric shock.

This pump has a grounding conductor and grounding-type attachment plug. To reduce the risk of electric shock, be certain that the pump is connected only to a properly grounded, grounding-type receptacle.



1. General information

1.1 Target group

These installation and operating instructions are intended for professional installers.

1.2 Symbols used in this document



Warning

If these safety instructions are not observed, it may result in personal injury.



Warning

If these instructions are not observed, it may lead to electric shock with consequent risk of serious personal injury or death.



If these safety instructions are not observed, it may result in malfunction or damage to the equipment.



Notes or instructions that make the job easier and ensure safe operation.

2. Receiving the product

2.1 Inspecting the product

Check that the product received is in accordance with the order.

Check that the voltage and frequency of the product match voltage and frequency of the installation site. See section 6.4.1 *Nameplate*.

2.2 Scope of delivery

The box contains the following items:

- 1 Grundfos SCALA pump
- 1 quick guide
- 1 safety instructions booklet.

3. Installing the product

3.1 Location

The pump can be installed indoors or outdoors, but it must not be exposed to frost.

We recommend that you install the pump near a drain or in a drip tray connected to a drain in order to lead away possible condensation from cold surfaces.

3.1.1 Minimum space

The pump can be installed in small spaces such as a cupboard. It requires a minimum space of 430 x 215 x 325 mm (17 x 8.5 x 12.8 inches).

Even though the pump does not require much space, we recommend that you leave enough space for service and maintenance access.

3.1.2 Installing the product in frosty environment

If the pump is to be installed outdoors where frost may occur, enclose it completely in insulating material to keep it from freezing.

3.2 System sizing



Warning

The system in which the pump is incorporated must be designed for the maximum pump pressure.

The pump is factory-set to three bar outlet pressure which can be adjusted according to the system in which it is incorporated.

The tank precharge pressure is 1.25 bar (18 psi).

3.3 Mechanical installation



Warning

Before starting any work on the product, make sure that the power supply has been switched off and that it cannot be accidentally switched on.

3.4 Foundation

Fasten the pump to a solid horizontal foundation by means of screws through the holes in the base plate. See fig. 1.

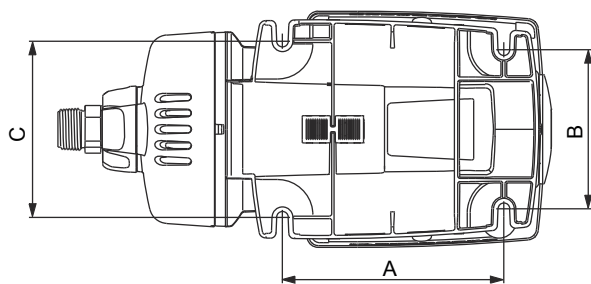

Fig. 1 Base plate

A	130 mm	5.12 inches
B	181 mm	7.13 inches
C	144 mm	5.67 inches

3.4.1 Pipework

Make sure that the pump is not stressed by the pipework.

The pumps are equipped with flexible connections, $\pm 5^\circ$, to facilitate the connection of inlet and outlet pipes. The inlet and outlet ports can be loosened by turning the union nuts by hand.

Caution

Always loosen and tighten inlet and outlet union nuts by hand.

1. Carefully screw the inlet and outlet connections on to the inlet and outlet ports using a pipe wrench or similar tool.
2. Then fit the connections to the inlet and outlet holding the connections with one hand, and tightening the union nuts with the other hand. See fig. 2.

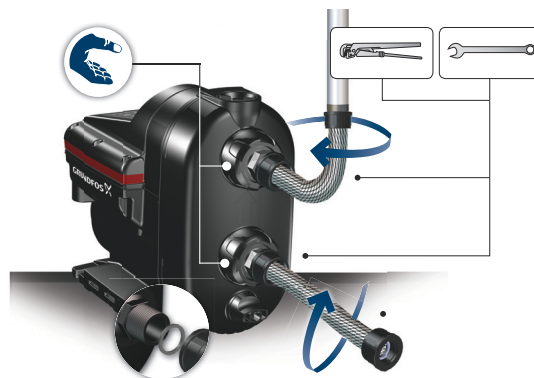

Fig. 2 How to fit the connections

3.4.2 How to reduce noise in the installation

Vibrations from the pump may be transferred to the surrounding structure and create noise in the 20-1000 Hz spectrum, also called the bass spectrum.

Correct installation using a vibration-damping rubber pad, flexible hoses and correctly placed pipe hangers for rigid pipes can reduce the noise experienced by up to 50 %. See fig. 3.

Place pipe hangers for the rigid pipes close to the connection of the flexible hose.

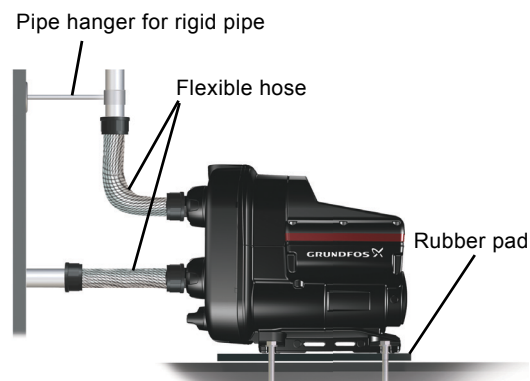

Fig. 3 How to reduce noise in the installation

TM06 4318 1915

TM06 3809 1015

TM06 4321 1915

3.5 Installation examples

Fittings, hoses and valves are not supplied with the pump.

3.5.1 Mains water pressure boosting

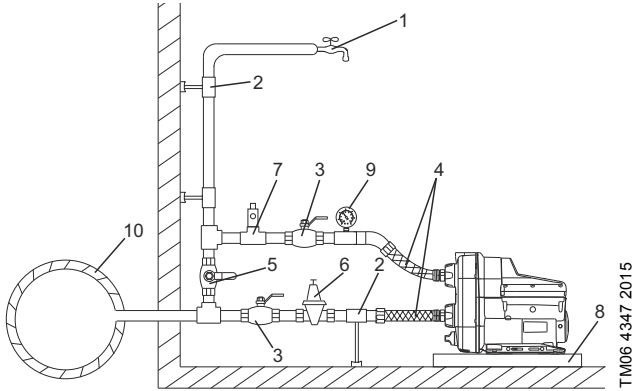

Fig. 4 Mains water pressure boosting

TM06 4347 2015

Pos.	Description
1	Highest tapping point
2	Pipe hangers and supports
3	Isolating valves
4	Flexible hoses
5	Bypass valve
6	Optional pressure-reducing valve on the inlet side if the inlet pressure can exceed 10 bar (145 psi)
7	Optional pressure-relief valve on the outlet side if the installation cannot stand up to a pressure of 6 bar (85 psi)
8	Drip tray. Install the pump on a small stand to avoid the ventilation holes from being flooded.
9	Pressure gauge
10	Mains water pipe

3.5.2 Suction from a well

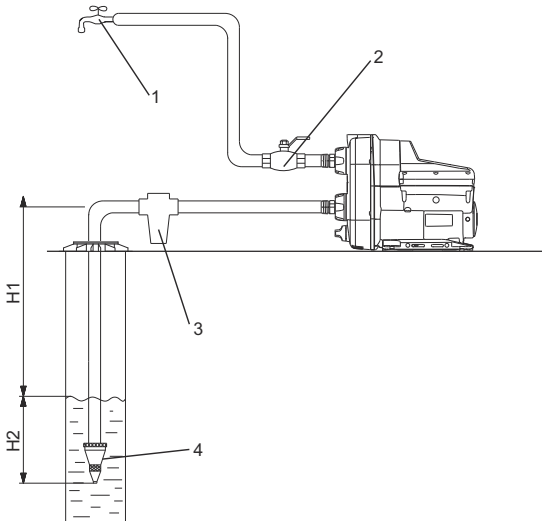

Fig. 5 Suction from a well

TM06 4349 2015

Pos.	Description
1	Highest tapping point
2	Isolating valve
3	Inlet filter. If the water can contain sand, gravel or other debris, please install a filter on the inlet side to protect the pump and installation.
4	Foot valve with strainer
H1	Maximum suction lift is 8 m (29 ft)

Pos. Description

H2 Inlet pipe must be submersed at least 0.5 m (1.64 ft)

3.5.3 Suction from freshwater tank

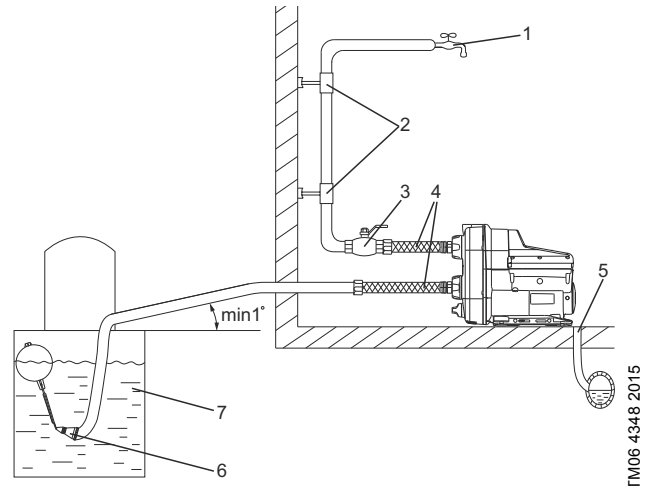

Fig. 6 Suction from freshwater tank

TM06 4348 2015

Pos.	Description
1	Highest tapping point
2	Pipe hangers
3	Isolating valve
4	Flexible hoses
5	Drain to sewer
6	Foot valve with strainer
7	Freshwater tank

3.6 Suction pipe length

The overview below shows the different possible pipe lengths, depending on the vertical pipe length.

The overview is only intended as a guide.

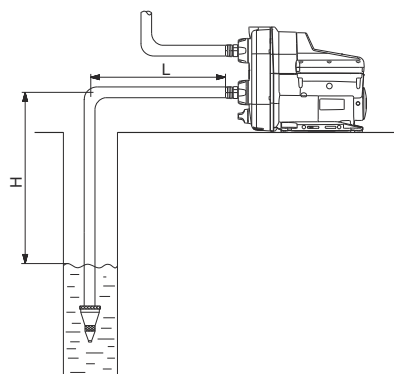

Fig. 7 Suction pipe length

TM06 4372 2115

DN 32		DN 40	
H [m (ft)]	L [m (ft)]	H [m (ft)]	L [m (ft)]
0 (0)	68 (223)	0 (0)	207 (679)
3 (10)	43 (141)	3 (10)	129 (423)
6 (20)	17 (56)	6 (20)	52 (171)
7 (23)	9 (30)	7 (23)	26 (85)
8 (26)	0 (0)	8 (26)	0 (0)

Preconditions:

Maximum flow velocity: 1 l/s (16 gpm)

Inside roughness of pipes: 0.01 mm (0.0004 inch).

Size	Inside pipe diameter	Pressure loss
DN 32	28 mm (1.1 inches)	0.117 m/m (5 psi/100 ft)
DN 40	35.2 mm (1.4 inches)	0.0387 m/m (1.6 psi/100 ft)

3.7 Electrical connection

3.7.1 Plug connection



Warning

Check that the voltage and frequency of the product match voltage and frequency of the installation site.



Warning

If the power supply cable is damaged, it must be replaced by the manufacturer, his service agent or similarly qualified persons in order to avoid hazard.



Warning

As a precaution, the product must be connected to a socket with earth connection.

Note

We recommend that you fit the permanent installation with an earth leakage circuit breaker (ELCB) with a tripping current < 30 mA.

The pump incorporates current and temperature dependent motor protection.

3.7.2 Connections without plug



Warning

The electrical connection must be carried out by an authorised electrician in accordance with local regulations.



Warning

Before making any connections in the product, make sure that the power supply has been switched off and that it cannot be accidentally switched on.

The product must be connected to an external mains switch with a contact gap of at least 3 mm [0.12 inch] in all poles.

4. Starting up the product

Caution

Do not start the pump until it has been filled with liquid.

4.1 Priming the pump

1. Unscrew the priming plug and pour minimum 1.7 litres (0.45 gallons) of water into the pump housing. See fig. 8.
2. Screw the priming plug on again.

Note

If the suction depth exceeds 6 m (20 ft), it may be necessary to prime the pump more than once.

Caution

Always tighten priming and drain plugs by hand.

4.2 Starting the pump

1. Open a tap to prepare the pump for venting.
2. Insert the power plug into the socket or turn on the power supply and the pump will start.
3. When water flows without air, close the tap.
4. Open the highest tapping point in the installation, preferably a shower.
5. Adjust the pressure to the required pressure by means of the  buttons.
6. Close the tapping point.

Startup has been completed.

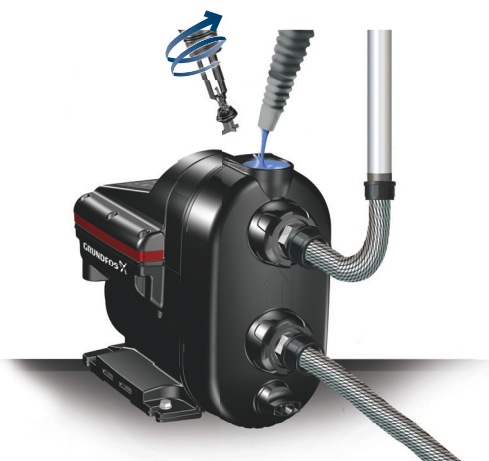

Fig. 8 Priming the pump

TM06 4204 1615

4.3 Shaft seal run-in

The shaft-seal faces are lubricated by the pumped liquid, meaning that there may be a certain amount of leakage from the shaft seal.

When the pump is started up for the first time, or when the shaft seal has been replaced, a certain run-in period is required before the leakage is reduced to an acceptable level. The time required for this depends on the operating conditions, that is, every time the operating conditions change, a new run-in period will be started.

Under normal conditions, the leaking liquid will evaporate. As a result, no leakage will be detected.

5. Storing and handling the product

5.1 Handling

Caution Take care not to drop the pump as it may break.

5.2 Storing

In case the pump is to be stored for a period of time, drain it and store it in a dry location.

Temperature range during storing must be -40 to 70 °C (104 to 158 °F).

5.3 Winterizing

If the pump is going to be out of operation during the winter and can be exposed to frost, it must be disconnected from the power supply and winterized.

Proceed as follows:

1. Stop the pump by means of the on/off button .
2. Disconnect the power supply.
3. Open a tap to release the pressure in the pipe system.
4. Close the isolating valves and/or drain the pipes.
5. Gradually loosen the priming plug to release the pressure in the pump.
6. Remove the drain plug to drain the pump. See fig. 9.



Fig. 9 Draining the pump

5.3.1 Startup after the winter

Check that the pump is not blocked by following the steps in section 9.1 *Deblocking the pump*.

See section 4. *Starting up the product*.

6. Product introduction

6.1 Product description

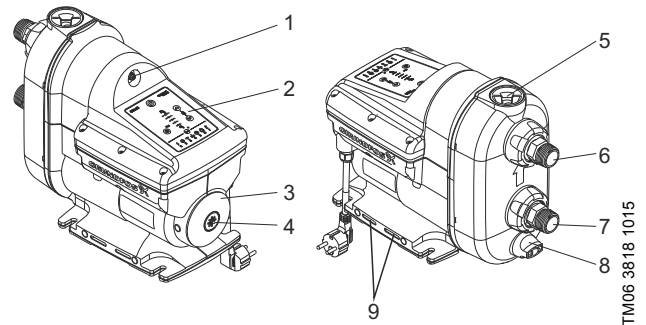

Fig. 10 Grundfos SCALA pump

Pos.	Description
1	Air valve for built-in pressure tank
2	Operating panel. See section 7. <i>Control functions</i> .
3	Nameplate. See section 6.4.1 <i>Nameplate</i> .
4	Plug for access to pump shaft. See section 9.1 <i>Deblocking the pump</i> .
5	Priming plug. See section 4.1 <i>Priming the pump</i> .
6	Outlet opening. With $\pm 5^\circ$ flexible connection. See section 3.4.1 <i>Pipework</i> .
7	Inlet opening. With $\pm 5^\circ$ flexible connection. See section 3.4.1 <i>Pipework</i> .
8	Drain plug. See section 5.3 <i>Winterizing</i>
9	Ventilation holes. Must not be flooded.

6.2 Application

The pump is suitable for pressure boosting of fresh water in domestic water supply systems.

6.3 Pumped liquids

The pump is designed for clean fresh water and chlorinated water < 300 ppm.

TM06 4203 1615

TM06 3818 1015

6.4 Identification

6.4.1 Nameplate

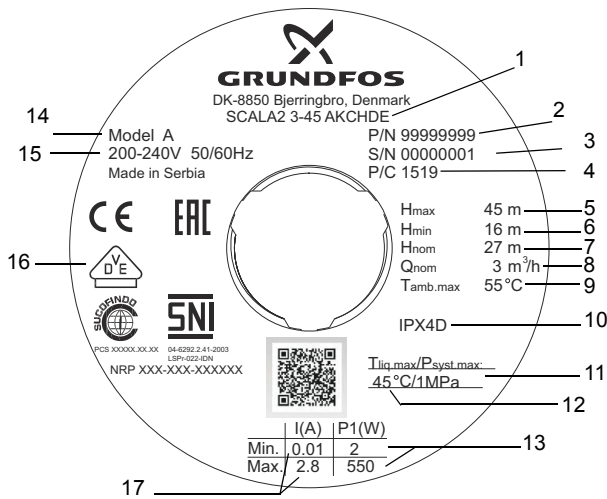

TM06 4340 2015

Fig. 11 Example of nameplate

Pos.	Description
1	Type designation
2	Product number
3	Serial number
4	Production code (year and week)
5	Maximum head
6	Minimum head
7	Rated head
8	Rated flow rate
9	Maximum ambient temperature
10	IP class
11	Maximum operation pressure
12	Maximum liquid temperature
13	Minimum and maximum rated power
14	Model
15	Voltage and frequency
16	Approvals
17	Minimum and maximum rated current

6.4.2 Type key

	SCALA2	3	-45	A	K	C	H	D	E
Type range:	SCALA1	Economy							
	SCALA2	Comfort							
Rated flow rate [m³/h]									
Maximum head [m]									
Material code:									
A:	Standard								
Supply voltage:									
K:	1 x 200-240 V, 50/60 Hz								
M:	1 x 208-230 V, 60 Hz								
V:	1 x 115 V, 60 Hz								
W:	1 x 100-115 V, 50/60 Hz								
Motor:									
C:	High-efficiency motor with frequency converter								
Mains cable and plug:									
A:	Cable with plug, IEC type I, AS/NZS3112, 2 m								
B:	Cable with plug, IEC type B, NEMA 5-15P, 6 ft								
C:	Cable with plug, IEC, type E&F, CEE7/7, 2 m								
D:	Cable without plug, 2 m								
G:	Cable with plug, IEC type G, BS1363, 2 m								
H:	Cable with plug, IEC type I, IRAM 2073, 2 m								
J:	Cable with plug, NEMA 6-15P, 6 ft								
Controller:									
D:	Integrated frequency converter								
Thread:									
A:	R 1" EN 1.4308								
C:	NPT 1" EN 1.4308								
E:	R 1" composite material								
F:	NPT 1" composite material								

7. Control functions

7.1 Menu overview, SCALA2



Fig. 12 SCALA2 operating panel

TM06 3301 5114

SCALA2	Function
	On/off
	Increases the outlet pressure
	Decreases the outlet pressure
	Resets alarms
	Indicates the required outlet pressure
	Indicates that the pump has been stopped manually
	Indicates that the operating panel is locked

7.1.1 Pressure indicator, SCALA2

The pressure indicator shows the required outlet pressure from 1.5 to 5.5 bars (22 to 80 psi) in 0.5 bar (7.5 psi) intervals. The illustration below shows a pump set to 3 bar (44 psi) indicated by two green lights and a pump set to 3.5 bar (51 psi) indicated by one green light.

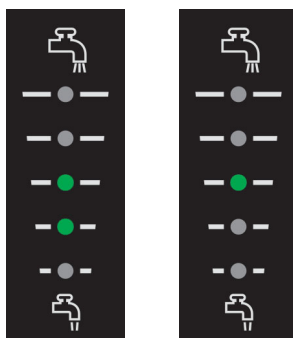

Fig. 13 SCALA2 outlet pressure indication

TM06 4345 2015

	BAR	PSI	Water column [m]	kPa	MPa
	5.5	80	55	550	0.55
	5.0	73	50	500	0.50
	4.5	65	45	450	0.45
	4.0	58	40	400	0.40
	3.5	51	35	350	0.35
	3.0	44	30	300	0.30
	2.5	36	25	250	0.25
	2.0	30	20	200	0.20
	1.5	22	15	150	0.15

TM06 4187 1615

Fig. 14 Pressure indication table

The pressure settings 4.5, 5.0 and 5.5 bar (65, 73 and 80 psi) require a minimum positive inlet pressure which is maximum 4 bar (58 psi) lower than the required outlet pressure.

Note

Example: If the required outlet pressure is 5 bar, the minimum inlet pressure must be 1 bar (14.5 psi).

7.1.2 Indicator lights, SCALA2



Indications	Description
	Operating indications
	The operating panel is locked
	Power supply failure
	The pump is blocked, e.g. the shaft seal has seized up
	Leakage in the system
	Dry-running or water shortage*
	The maximum pressure has been exceeded
	The maximum runtime has been exceeded
	The temperature is outside the range

* For fault number 4, dry-running, the pump will try to reset automatically in a sequence of three attempts within the first minute. After this, eight attempts within an hour and repeatedly once every 24 hours. For the remaining faults, 1, 2, 3, 5, 6 and 7, the pump will reset whenever the cause has disappeared or been remedied.

For further information about system status, see section 12.1 Grundfos Eye operating indications.

8. Operating the controller



8.1 Setting the outlet pressure

Adjust the outlet pressure by pressing  .



8.2 Locking and unlocking the operating panel

The operating panel can be locked, which means that the buttons do not function and no settings can be changed accidentally.

How to lock the operating panel

1. Hold down the   buttons simultaneously for three seconds.
2. The operating panel is locked when  symbol lights up.

How to unlock the operating panel

1. Hold down the   buttons simultaneously for three seconds.
2. The operating panel is unlocked when  symbol turns off.

8.3 Expert settings, SCALA2

Note *Expert settings are for installers only.*

The expert setting menu allows the installer to toggle between the functions auto reset, anti cycling and maximum continuous operating time.

Auto reset

This function allows the pump to automatically reset the alarms when operating conditions are back to normal.

Anti cycling

This function monitors the stops and starts of the pump and will give an alarm if the pump starts too frequently. If the pump starts and stops too frequently, there is a leakage in the system and the pump will show alarm 3.



Leakage in the system.

Maximum continuous operating time



This function is a timer that will turn off the pump if it runs continuously for 30 minutes. If the pump exceeds the running time of 30 minutes, it will show alarm 6.







Maximum runtime exceeded.

8.3.1 Accessing the expert settings

Proceed as follows:

1. Hold down the  button for five seconds.
2. The  symbol will start flashing to indicate that the expert settings are active.

The pressure indicator now acts as the expert "menu". A flashing green diode is the cursor. Move the cursor using the   buttons, and toggle the selection on or off using the  button. The diode for each setting will light up when the setting is active.

 Move cursor up

 Move cursor down

 Toggle settings

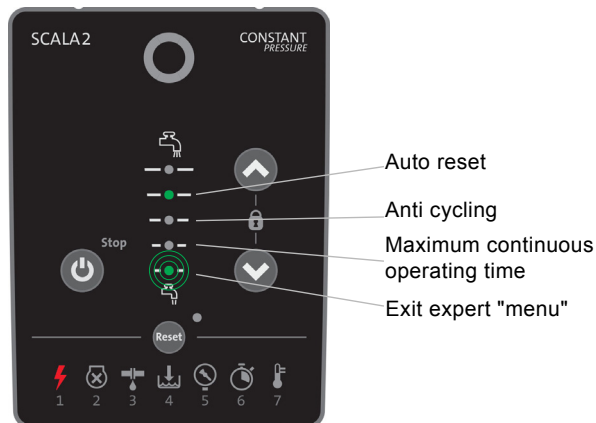



Fig. 15 Expert "menu" overview

8.4 Resetting to factory settings

The pump can be reset to factory setting by pressing the   buttons simultaneously for five seconds.

9. Starting up the product after shutdown or standstill

9.1 Deblocking the pump



Warning

Before starting any work on the product, make sure that the power supply has been switched off and that it cannot be accidentally switched on.

The end cover incorporates a plug which can be removed by means of a suitable tool. This makes it possible to deblock the pump shaft if it has seized up as a result of inactivity.

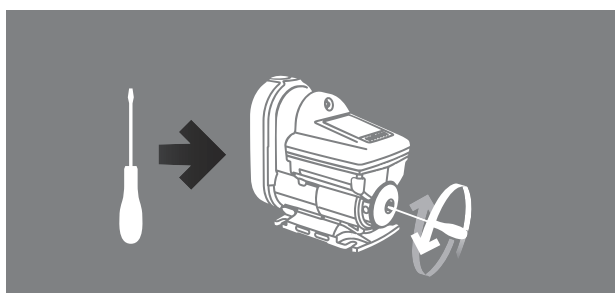

Fig. 16 Deblocking the pump

9.2 Controller settings

The pump will remember the controller settings even if it is turned off.

9.3 Priming

If the pump has been drained, it must be filled with liquid before startup. See section 4. *Starting up the product.*

TM06 4346 2015

TM06 4202 1615

10. Servicing the product



Warning

Before starting any work on the product, make sure that the power supply has been switched off and that it cannot be accidentally switched on.

10.1 Maintaining the product

10.1.1 Insect filter

The pump has an insect filter to prevent insects from nesting in the pump.

The filter is placed on the bottom and can easily be removed and cleaned with a stiff brush. See fig. 17.

Clean the insect filter once a year or as needed.

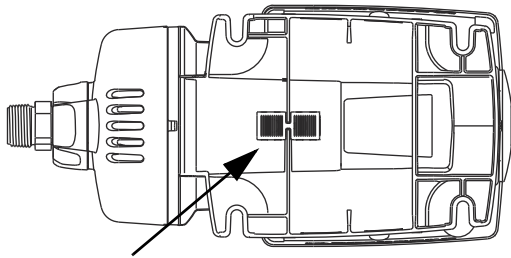

Fig. 17 Insect filter

10.1.2 Inlet and outlet valves

The pump is maintenance-free, but we recommend that you check and clean the inlet and outlet non-return valves once a year or as needed.

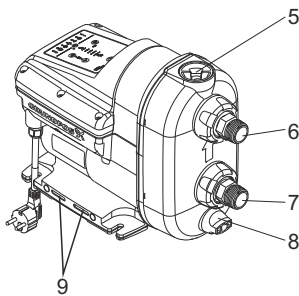

Fig. 18 SCALA pump

To remove the inlet non-return valve, follow the steps below:

1. Turn off the power supply and disconnect the power plug.
2. Shut off the water source.
3. Open a tap to release the pressure in the pipe system.
4. Close the isolating valves and/or drain the pipes.
5. Gradually open and remove the priming plug. See fig. 18 (pos. 5).
6. Remove the drain plug and drain the pump. See fig. 18 (pos. 8).
7. Unscrew the union nut holding the inlet connection. See fig. 18 (pos. 7). Depending on the installation type, it may be necessary to remove the pipes from both the inlet and outlet connections.
8. Pull out the inlet connection.
9. Pull out the inlet non-return valve.
10. Clean the non-return valve with warm water and a soft brush.
11. Assemble the components in reverse order.

To remove the outlet non-return valve, follow the steps below:

1. Turn off the power supply and disconnect the power plug.
2. Shut off the water source.
3. Open a tap to release the pressure in the pipe system.
4. Close the isolating valves and/or drain the pipes.
5. Gradually open and remove the priming plug. See fig. 18 (pos. 5). The plug and non-return valve are one unit.
6. Clean the non-return valve with warm water and a soft brush.
7. Assemble the components in reverse order.

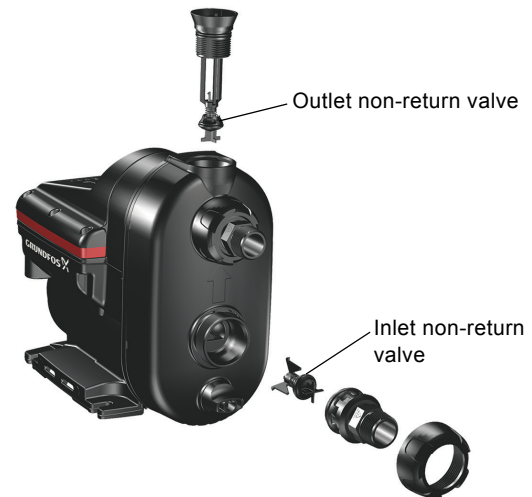

Fig. 19 Outlet and inlet non-return valves

10.2 Customer service information

For further information on service parts, see Grundfos Product Center on www.product-selection.grundfos.com.

10.3 Service kits

For further information on service kits, see Grundfos Product Center on www.grundfos.com.

11. Taking out of operation

For further information on how to take the product out of operation, see end-of-life documentation on www.grundfos.com.







TM06 4537 2515

TM06 4331 1915

TM06 3818 1015

12. Fault finding the product

12.1 Grundfos Eye operating indications

Grundfos Eye	Indication	Description
	No lights on.	Power off. The pump is not running.
	Two opposite green indicator lights running in the direction of rotation of the pump.	Power on. The pump is running.
	Two opposite green indicator lights at a 45 ° angle is the icon used throughout this document for pump running.	Power on. The pump is running.
	Two opposite green indicator lights permanently on.	Power on. The pump is not running.
	Two opposite red indicator lights flashing simultaneously.	Alarm. The pump has stopped.
	Two opposite red indicator lights is the icon used throughout this document for pump stopped.	Alarm. The pump has stopped.

12.2 Fault resetting

A fault indication can be reset in one of the following ways:

- When you have eliminated the fault cause, reset the pump manually by pressing the  button. The pump will then revert to normal duty.
- If the fault disappears by itself, the pump will attempt to reset automatically and the fault indication will disappear if automatic reset is successful.

















12.3 Fault finding chart

**Warning**

Before starting fault finding, switch off the power supply.

Make sure that the power supply cannot be accidentally switched on.

Fault	Grundfos Eye	Indicator light	Automatic reset	Cause	Remedy
1. The pump is not running.		-	-	a) Power supply failure	Switch on the power supply. Check the cables and cable connections for defects and loose connections and check for blown fuses in the electrical installation.
			Yes	b) The power supply is out of prescribed voltage range	Check the power supply and the pump nameplate. Reestablish the power supply within the prescribed voltage range.
			No	c) The shaft seal has seized up	See section 9. <i>Starting up the product after shutdown or standstill.</i>
			No	d) The pump is blocked by impurities	See section 9. <i>Starting up the product after shutdown or standstill.</i> Contact Grundfos Service if the problem persists.
			Yes	e) Dry running	Check the water source, and prime the pump.
			No	f) The maximum runtime has been exceeded	Check the installation for leakage and reset the alarm.
			No	g) The internal non-return valve is defective or blocked in completely or partly open position	Clean, repair or replace the non-return valve. See section 10. <i>Servicing the product.</i>
2. The pump is running.			-	a) Leakage from the pipework, or the non-return valve not properly closed due to impurities	Check and repair the pipework, or clean, repair or replace the non-return valve.
			-	b) Small continuous consumption	Check the taps and reconsider the usage pattern (ice machines, water evaporators for air-conditioning, etc.).
			-	c) The temperature is below freezing point	Consider protecting the pump and the installation against frost.
3. Pump performance is insufficient.		-	-	a) The pump inlet pressure is too low	Check the inlet conditions of the pump.
		-	-	b) The pump is undersized.	Replace the pump with a bigger pump.
		-	-	c) The inlet pipe, the inlet strainer or the pump is partly blocked by impurities	Clean the inlet pipe or the pump.
		-	-	d) Leakage in the inlet pipe	Repair the inlet pipe.
		-	-	e) Air in inlet pipe or the pump	Prime the inlet pipe and the pump. Check the inlet conditions of the pump.
		-	-	f) The required outlet pressure is too low for the installation	Increase the pressure setting (arrow up).
			Yes	g) The maximum temperature has been exceeded - the pump is running at reduced performance	Check the cooling conditions. Protect the pump against direct sunlight or any nearby heat sources.

Fault	Grundfos Eye	Indicator light	Automatic reset	Cause	Remedy
4. System overpressure.			Yes	a) The maximum pressure has been exceeded - the inlet pressure is higher than 6 bar, 0.6 MPa (85 psi)	Check the inlet conditions.
			Yes	b) The maximum pressure has been exceeded - equipment elsewhere in the system causes a high pressure at the pump (e.g. water heater or defective safety equipment)	Check the installation.
5. The pump can be reset, but runs only for a few seconds.			Yes	a) Dry running or water shortage	Check the water source, and prime the pump.
			Yes	b) The inlet pipe is blocked by impurities	Clean the inlet pipe.
			Yes	c) The foot or non-return valve is blocked in closed position	Clean, repair or replace the foot or non-return valve.
			Yes	d) Leakage in the inlet pipe	Repair the inlet pipe.
			Yes	e) Air in the inlet pipe or the pump	Prime the inlet pipe and the pump. Check the inlet conditions of the pump.
6. The pump can be reset, but starts repeatedly, immediately after stopping.			No	a) The internal non-return valve is defective or blocked in completely or partly open position.	Clean, repair or replace the non-return valve.
			No	b) The tank precharge pressure is not correct.	Adjust the tank precharge pressure to 70 % of the required outlet pressure.

13. Technical data

13.1 Operating conditions

Maximum ambient temperature:

1 x 208-230 V, 60 Hz:	45 °C (113 °F)
1 x 115 V, 60 Hz:	45 °C (113 °F)
1 x 200-240 V, 50/60 Hz:	55 °C (131 °F)

Maximum liquid temperature: 45 °C (113 °F)

Maximum system pressure: 10 bar, 1 MPa (145 psi)

Maximum inlet pressure: 6 bar, 0.6 MPa (85 psi)

Maximum head: 45 m (147 ft)

IP rating: X4D (outdoor installation)

Pumped liquid: Clean water

Noise level: < 45 dB(A)

13.2 Mechanical data

Pipe connections are R 1" or NPT 1".

13.3 Electrical data

Type	Supply voltage [V]	Frequency [Hz]	I _{max.} [A]	P1 [W]	Stand-by power [W]
					2
SCALA2	1 x 200-240	50/60	2.3 - 2.8	550	2
					2
SCALA2	1 x 208-230	60	2.3 - 2.8	550	2
SCALA2	1 x 115	60	5 - 5.7	560	2

Type	Supply voltage [V]	Frequency [Hz]	Plug
			IEC, type E&F
			IEC, type I
			IEC, type G
			None
SCALA2	1 x 200-240	50/60	
SCALA2	1 x 208-230	60	NEMA 6-15P
SCALA2	1 x 115	60	IEC, type B, NEMA 5-15P

13.3.1 Dimensions and weights

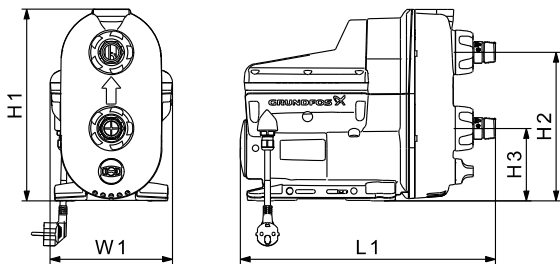

TM06 3305 5114

Type	H1 [mm] [inch]	H2 [mm] [inch]	H3 [mm] [inch]	W1 [mm] [inch]	L1 [mm] [inch]	Weight [kg] [lbs]
SCALA2	302 [11.9]	234 [9.2]	114 [4.5]	193 [7.6]	403 [15.9]	10 [22]

14. Disposal

This product has been designed with focus on the disposal and recycling of materials. The following disposal values apply to all variants of Grundfos SCALA pumps:

- minimum 85 % for recycling
- maximum 10 % for incineration
- maximum 5 % for depositing.

Values are percent of total weight.

This product or parts of it must be disposed of in an environmentally sound way according to local regulations.

Subject to alterations.

Argentina

Bombas GRUNDFOS de Argentina S.A.
Ruta Panamericana km. 37.500 Centro
Industrial Garin
1619 Garin Pcia. de B.A.
Phone: +54-3327 414 444
Telefax: +54-3327 45 3190

Australia

GRUNDFOS Pumps Pty. Ltd.
P.O. Box 2040
Regency Park
South Australia 5942
Phone: +61-8-8461-4611
Telefax: +61-8-8340 0155

Austria

GRUNDFOS Pumpen Vertrieb Ges.m.b.H.
Grundfosstraße 2
A-5082 Grödig/Salzburg
Tel.: +43-6246-883-0
Telefax: +43-6246-883-30

Belgium

N.V. GRUNDFOS Bellux S.A.
Boomssesteenweg 81-83
B-2630 Aartselaar
Tél.: +32-3-870 7300
Télécopie: +32-3-870 7301

Belarus

Представительство ГРУНДФОС в
Минске
220125, Минск
ул. Шафарьянская, 11, оф. 56, БЦ
«Порт»
Тел.: +7 (375 17) 286 39 72/73
Факс: +7 (375 17) 286 39 71
E-mail: minsk@grundfos.com

Bosna and Herzegovina

GRUNDFOS Sarajevo
Zmaja od Bosne 7-7A,
BH-71000 Sarajevo
Phone: +387 33 592 480
Telefax: +387 33 590 465
www.ba.grundfos.com
e-mail: grundfos@bih.net.ba

Brazil

BOMBAS GRUNDFOS DO BRASIL
Av. Humberto de Alencar Castelo Branco,
630
CEP 09850 - 300
São Bernardo do Campo - SP
Phone: +55-11 4393 5533
Telefax: +55-11 4343 5015

Bulgaria

Grundfos Bulgaria EOOD
Slatina District
Iztochna Tangenta street no. 100
BG - 1592 Sofia
Tel. +359 2 49 22 200
Fax. +359 2 49 22 201
email: bulgaria@grundfos.bg

Canada

GRUNDFOS Canada Inc.
2941 Brighton Road
Oakville, Ontario
L6H 6C9
Phone: +1-905 829 9533
Telefax: +1-905 829 9512

China

GRUNDFOS Pumps (Shanghai) Co. Ltd.
10F The Hub, No. 33 Suhong Road
Minhang District
Shanghai 201106
PRC
Phone: +86 21 612 252 22
Telefax: +86 21 612 253 33

Croatia

GRUNDFOS CROATIA d.o.o.
Buzinski prilaz 38, Buzin
HR-10010 Zagreb
Phone: +385 1 6595 400
Telefax: +385 1 6595 499
www.hr.grundfos.com

Czech Republic

GRUNDFOS s.r.o.
Čajkovského 21
779 00 Olomouc
Phone: +420-585-716 111
Telefax: +420-585-716 299

Denmark

GRUNDFOS DK A/S
Martin Bachs Vej 3
DK-8850 Bjerringbro
Tlf.: +45-87 50 50 50
Telefax: +45-87 50 51 51
E-mail: info_GDK@grundfos.com
www.grundfos.com/DK

Estonia

GRUNDFOS Pumps Eesti OÜ
Peterburi tee 92G
11415 Tallinn
Tel: + 372 606 1690
Fax: + 372 606 1691

Finland

OY GRUNDFOS Pumput AB
Mestarintie 11
FIN-01730 Vantaa
Phone: +358-(0)207 889 900
Telefax: +358-(0)207 889 550

France

Pompes GRUNDFOS Distribution S.A.
Parc d'Activités de Chesnes
57, rue de Malacombe
F-38290 St. Quentin Fallavier (Lyon)
Tél.: +33-4 74 82 15 15
Télécopie: +33-4 74 94 10 51

Germany

GRUNDFOS GMBH
Schlüterstr. 33
40699 Erkrath
Tel.: +49-(0) 211 929 69-0
Telefax: +49-(0) 211 929 69-3799
e-mail: infoservice@grundfos.de
Service in Deutschland:
e-mail: kundendienst@grundfos.de

HILGE GmbH & Co. KG

Hilgestrasse 37-47
55292 Bodenheim/Rhein
Germany
Tel.: +49 6135 75-0
Telefax: +49 6135 1737
e-mail: hilge@hilge.de

Greece

GRUNDFOS Hellas A.E.B.E.
20th km. Athinon-Markopoulou Av.
P.O. Box 71
GR-19002 Peania
Phone: +0030-210-66 83 400
Telefax: +0030-210-66 46 273

Hong Kong

GRUNDFOS Pumps (Hong Kong) Ltd.
Unit 1, Ground floor
Siu Wai Industrial Centre
29-33 Wing Hong Street &
68 King Lam Street, Cheung Sha Wan
Kowloon
Phone: +852-27861706 / 27861741
Telefax: +852-27858664

Hungary

GRUNDFOS Hungária Kft.
Park u. 8
H-2045 Törökbálint,
Phone: +36-23 511 110
Telefax: +36-23 511 111

India

GRUNDFOS Pumps India Private Limited
118 Old Mahaballipuram Road
Thoraiakkam
Chennai 600 096
Phone: +91-44 2496 6800

Indonesia

PT. GRUNDFOS POMPA
Graha Intrub Lt. 2 & 3
Jin. Cililitan Besar No.454. Makasar,
Jakarta Timur
ID-Jakarta 13650
Phone: +62 21-469-51900
Telefax: +62 21-460 6910 / 460 6901

Ireland

GRUNDFOS (Ireland) Ltd.
Unit A, Merrywell Business Park
Ballymount Road Lower
Dublin 12
Phone: +353-1-4089 800
Telefax: +353-1-4089 830

Italy

GRUNDFOS Pompe Italia S.r.l.
Via Gran Sasso 4
I-20060 Truccazzano (Milano)
Tel.: +39-02-95838112
Telefax: +39-02-95309290 / 95838461

Japan

GRUNDFOS Pumps K.K.
Gotanda Metalion Bldg., 5F,
5-21-15, Higashi-gotanda
Shiagawa-ku, Tokyo
141-0022 Japan
Phone: +81 35 448 1391
Telefax: +81 35 448 9619

Korea

GRUNDFOS Pumps Korea Ltd.
6th Floor, Aju Building 679-5
Yeoksam-dong, Kangnam-ku, 135-916
Seoul, Korea
Phone: +82-2-5317 600
Telefax: +82-2-5633 725

Latvia

SIA GRUNDFOS Pumps Latvia
Deglava biznesa centrs
Augusta Deglava ielā 60, LV-1035, Rīga,
Tālr.: + 371 714 9640, 7 149 641
Fakss: + 371 914 9646

Lithuania

GRUNDFOS Pumps UAB
Smolensko g. 6
LT-03201 Vilnius
Tel: + 370 52 395 430
Fax: + 370 52 395 431

Malaysia

GRUNDFOS Pumps Sdn. Bhd.
7 Jalan Peguam U1/25
Glenmarie Industrial Park
40150 Shah Alam
Selangor
Phone: +60-3-5569 2922
Telefax: +60-3-5569 2866

Mexico

Bombas GRUNDFOS de México S.A. de
C.V.
Boulevard TLC No. 15
Parque Industrial Stiva Aeropuerto
Apodaca, N.L. 66600
Phone: +52-81-8144 4000
Telefax: +52-81-8144 4010

Netherlands

GRUNDFOS Netherlands
Veluwezoom 35
1326 AE Almere
Postbus 22015
1302 CA ALMERE
Tel.: +31-88-478 6336
Telefax: +31-88-478 6332
E-mail: info_gnl@grundfos.com

New Zealand

GRUNDFOS Pumps NZ Ltd.
17 Beatrice Tinsley Crescent
North Harbour Industrial Estate
Albany, Auckland
Phone: +64-9-415 3240
Telefax: +64-9-415 3250

Norway

GRUNDFOS Pumper A/S
Stramsveien 344
Postboks 235, Leirdal
N-1011 Oslo
Tlf.: +47-22 90 47 00
Telefax: +47-22 32 21 50

Poland

GRUNDFOS Pompy Sp. z o.o.
ul. Klonowa 23
Baranowo k. Poznania
PL-62-081 Przeźmierowo
Tel: (+48-61) 650 13 00
Fax: (+48-61) 650 13 50

Portugal

Bombas GRUNDFOS Portugal, S.A.
Rua Calvet de Magalhães, 241
Apartado 1079
P-2770-153 Paço de Arcos
Tel.: +351-21-440 76 00
Telefax: +351-21-440 76 90

Romania

GRUNDFOS Pompe România SRL
Bd. Biruintei, nr 103
Pantelimon county Ilfov
Phone: +40 21 200 4100
Telefax: +40 21 200 4101
E-mail: romania@grundfos.ro

Russia

ООО Грундфос Россия
109544, г. Москва, ул. Школьная, 39-41,
стр. 1
Тел. (+7) 495 564-88-00 (495) 737-30-00
Факс (+7) 495 564 88 11
E-mail grundfos.moscow@grundfos.com

Serbia

Grundfos Srbija d.o.o.
Omladinskih brigada 90b
11070 Novi Beograd
Phone: +381 11 2258 740
Telefax: +381 11 2281 769
www.rs.grundfos.com

Singapore

GRUNDFOS (Singapore) Pte. Ltd.
25 Jalan Tukang
Singapore 619264
Phone: +65-6681 9688
Telefax: +65-6681 9689

Slovakia

GRUNDFOS s.r.o.
Prievozska 4D
821 09 BRATISLAVA
Phona: +421 2 5020 1426
sk.grundfos.com

Slovenia

GRUNDFOS d.o.o.
Štandrova 8b, SI-1231 Ljubljana-Črnuče
Phone: +386 31 718 808
Telefax: +386 (0)1 5680 619
E-mail: slovenia@grundfos.si

South Africa

GRUNDFOS (PTY) LTD
Corner Mountjoy and George Allen Roads
Wilbart Ext. 2
Bedfordview 2008
Phone: (+27) 11 579 4800
Fax: (+27) 11 455 6066
E-mail: lsmart@grundfos.com

Spain

Bombas GRUNDFOS España S.A.
Camino de la Fuentequilla, s/n
E-28110 Algete (Madrid)
Tel.: +34-91-848 8800
Telefax: +34-91-628 0465

Sweden

GRUNDFOS AB
Box 333 (Lunnagårdsgatan 6)
431 24 Mölndal
Tel.: +46 31 332 23 000
Telefax: +46 31 331 94 60

Switzerland

GRUNDFOS Pumpen AG
Bruggacherstrasse 10
CH-8117 Fällanden/ZH
Tel.: +41-44-806 8111
Telefax: +41-44-806 8115

Taiwan

GRUNDFOS Pumps (Taiwan) Ltd.
7 Floor, 219 Min-Chuan Road
Taichung, Taiwan, R.O.C.
Phone: +886-4-2305 0868
Telefax: +886-4-2305 0878

Thailand

GRUNDFOS (Thailand) Ltd.
92 Chaloom Phrakiat Rama 9 Road,
Dokmai, Pravej, Bangkok 10250
Phone: +66-2-725 8999
Telefax: +66-2-725 8998

Turkey

GRUNDFOS POMPA San. ve Tic. Ltd. Sti.
Gebze Organize Sanayi Bölgesi
Ihsan dede Caddesi,
2. yol 200. Sokak No. 204
41490 Gebze/ Kocaeli
Phone: +90 - 262-679 7979
Telefax: +90 - 262-679 7905
E-mail: satis@grundfos.com

Ukraine

Бізнес Центр Європа
Столичне шосе, 103
м. Київ, 03131, Україна
Телефон: (+38 044) 237 04 00
Факс.: (+38 044) 237 04 01
E-mail: ukraine@grundfos.com

United Arab Emirates

GRUNDFOS Gulf Distribution
P.O. Box 16768
Jebel Ali Free Zone
Dubai
Phone: +971 4 8815 166
Telefax: +971 4 8815 136

United Kingdom

GRUNDFOS Pumps Ltd.
Grovebury Road
Leighton Buzzard/Beds. LU7 4TL
Phone: +44-1525-850000
Telefax: +44-1525-850011

U.S.A.

GRUNDFOS Pumps Corporation
17100 West 118th Terrace
Olathe, Kansas 66061
Phone: +1-913-227-3400
Telefax: +1-913-227-3500

Uzbekistan

Grundfos Tashkent, Uzbekistan The Repre-
sentative Office of Grundfos Kazakhstan in
Uzbekistan
38a, Oybek street, Tashkent
Телефон: (+998) 71 150 3290 / 71 150
3291
Факс: (+998) 71 150 3292

Addresses Revised 10.03.2015

98880508 0615

ECM: XXXXXXXX
