

VE.Bus BMS

www.victronenergy.com



VE.Bus BMS

Protects each individual cell of a Victron lithium iron phosphate (LiFePO₄ or LFP) battery

Each individual cell of a LiFePO₄ battery must be protected against over voltage, under voltage and over temperature.

Victron LiFePO₄ batteries have integrated Balancing, Temperature and Voltage control (acronym: BTV) and connect to the VE.Bus BMS with two M8 circular connector cord sets.

The BTVs of several batteries can be daisy chained. Up to ten batteries can be paralleled and up to four batteries can be series connected (BTVs are simply daisy-chained) so that a 48V battery bank of up to 2000Ah can be assembled. Please see our LiFePO₄ battery documentation for details.

The BMS will:

- shut down or disconnect loads in case of imminent cell under voltage,
- reduce charge current in case of imminent cell overvoltage or over temperature (VE.Bus products only, see below), and
- shut down or disconnect battery chargers in case of imminent cell overvoltage or over temperature.

Protects 12V, 24V and 48V systems

The operating voltage range of the BMS: 9 to 70V DC.

Communicates with all VE.Bus products

The VE.Bus BMS connects to a MultiPlus, Quattro or Phoenix inverter with a standard RJ45 UTP cable.

Other products, without VE.Bus can be controlled as shown below:

Load Disconnect

The Load Disconnect output is normally high and becomes free floating in case of imminent cell under voltage. Maximum current: 2A.

The Load Disconnect output can be used to control

- the remote on/off of a load, and/or
- the remote on/off of an electronic load switch (Battery Protect)

Charge Disconnect

The Charge Disconnect output is normally high and becomes free floating in case of imminent cell over voltage or over temperature. Maximum current: 10mA.

The Charge Disconnect output can be used to control

- the remote on/off of a charger and/or
- a Cyrix-Li-Charge relay and/or
- a Cyrix-Li-ct Battery Combiner

LED indicators

- **Enabled (blue):** VE.Bus products are enabled.
- **Cell>4V or temperature (red):** charge disconnect output low because of imminent cell over voltage or over temperature.
- **Cell>2,8V (blue):** load disconnect output high.

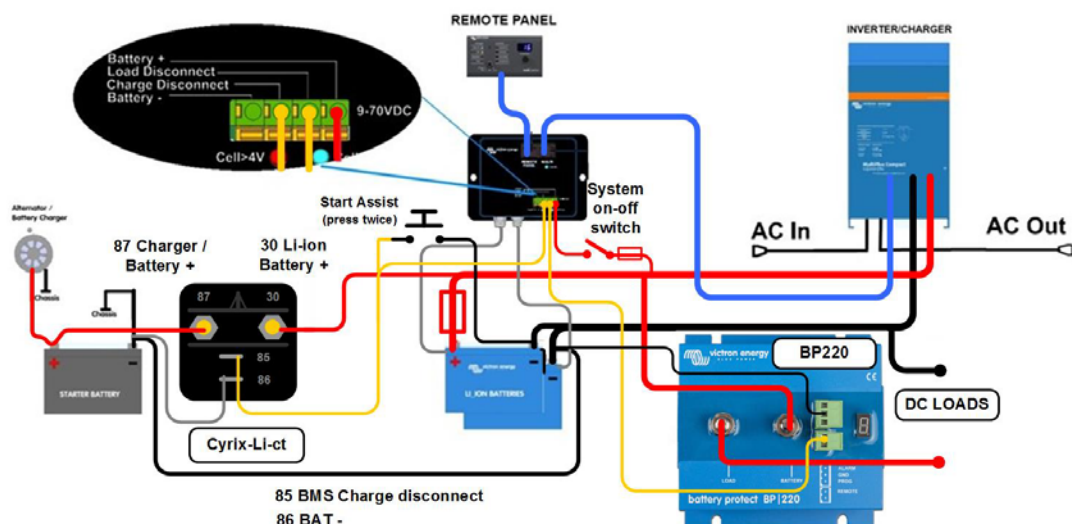

Figure 1: Application example for a vehicle or boat.

A Cyrix Li-ion Battery Combiner is used to connect to the starter battery and alternator.

The UTP cable to the inverter/charger also provides the minus connection to the BMS.

VE.Bus BMS	
Input voltage range	9 – 70V DC
Current draw, normal operation	10 mA (excluding Load Disconnect current)
Current draw, low cell voltage	2mA
Load Disconnect output	Normally high Source current limit: 2A Sink current: 0 A (output free floating)
Charge Disconnect output	Normally high Source current limit: 10mA Sink current: 0 A (output free floating)
GENERAL	
VE.Bus communication port	Two RJ45 sockets to connect to all VE.Bus products
Operating temperature	-20 to +50°C 0 - 120°F
Humidity	Max. 95% (non-condensing)
Protection grade	IP20
ENCLOSURE	
Material and colour	ABS, matt black
Weight	0,1kg
Dimensions (h x w x d)	105 x 78 x 32mm
STANDARDS	
Standards: Safety	EN 60950
Emission	EN 61000-6-3, EN 55014-1
Immunity	EN 61000-6-2, EN 61000-6-1, EN 55014-2
Automotive	Regulation UN/ECE-R10 Rev.4

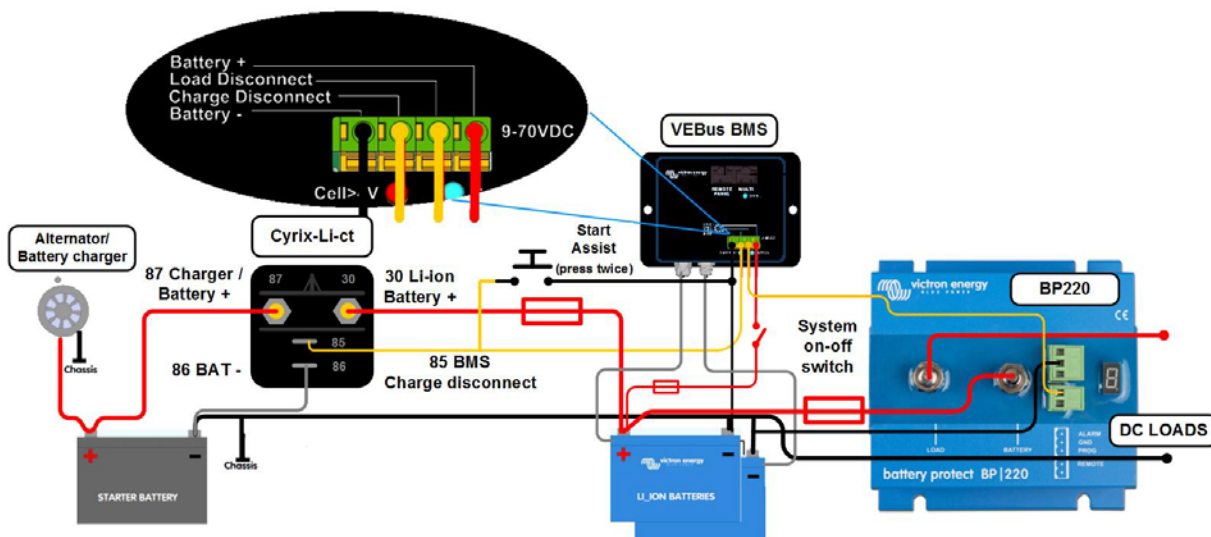

Figure 2: Application example for a vehicle or boat, without inverter/charger.



Four Cyrix Combiners especially designed for use with the VE.Bus BMS:

Cyrix-Li-ct (120A or 230A)

Is a battery combiner with a Li-ion adapted engage/disengage profile and a control terminal to connect to the Charge Disconnect of the BMS.

Cyrix-Li-Charge (120A or 230A)

Is a unidirectional combiner to insert in between a battery charger and the LFP battery. It will engage only when charge voltage from a battery charger is present on its charge-side terminal. A control terminal connects to the Charge Disconnect of the BMS.