

User manual

Solar Grid-tied Inverter

Product Model: SOFAR 25~50KTLX-G3



Catalog

Preface	II
1. Basic Safety Information	- 1 -
1.1. Requirement for Installation and Maintenance	- 1 -
1.2. Symbols and signs	- 4 -
2. Product Characteristics	- 7 -
2.1. Intended Use	- 7 -
2.2. Function Description	- 11 -
2.3. Electrical block diagram	- 12 -
2.4. Efficiency and derating curve	- 12 -
3. Installation	- 14 -
3.1. Installation Process	- 14 -
3.2. Checking Before Installation	- 14 -
3.3. Tools	- 17 -
3.4. Determining the Installation Position	- 19 -
3.5. Moving of inverter	- 21 -
3.6. Installation	- 22 -
4. Electrical Connection	- 24 -
4.1. Electrical Connection	- 25 -
4.2. Grounding Connection (PE)	- 25 -
4.3. Connect grid side of inverter (AC-Output)	- 27 -
4.4. Connect PV side of inverter(DC-Input)	- 30 -
4.5. Communication Connection	- 33 -
5. Commissioning of inverter	- 44 -
5.1. Cable Connection Inspection	- 44 -
5.2. Start Inverter	- 44 -
5.3. Shutdown inverter	- 45 -
5.4. Setting power quality response modes	- 45 -
6. Operation interface	- 46 -
6.1. Operation and Display Panel	- 46 -
6.2. Standard Interface	- 47 -
6.3. Main Interface	- 49 -
6.4. Updating Inverter Software	- 49 -
6.5. Smart meter instruction	- 49 -
7. Trouble shooting and maintenance	- 62 -
7.1. Troubleshooting	- 62 -
7.2. Maintenance	- 67 -
7.3. Fan Maintenance	- 67 -
8. Technical Data	- 69 -
9. Quality Assurance	- 75 -

Preface

Notice

The products, services or features you purchased shall be subject to the company's commercial contracts and terms. All or part of the products and services described in this document may not within the scope of your purchase. Unless additional terms and conditions in your contract, the company does not make any statement or guarantee on the contents of this document.

Save this Instruction

This manual must be considered as an integral part of the equipment. Customer can print the electronic version to hard copy and keeping properly for future reference. Anyone who operates the device at any time must operate in accordance with the requirements of this manual.

Copyright Declaration

The copyright of this manual belongs to Shenzhen SOFARSOLAR Co., Ltd. Any corporation or individual should not plagiarize, partially cope or fully copy (including software, etc.), not allow to duplication and publishment in any form and any way. All rights reserved, SOFARSOLAR reserves the right of final interpretation. This manual subject to modify according to user's or customer's feedback. Please check our website at <http://www.sofarsolar.com> for lasted version.

Document Updates

V1.2 2022-7-19

Initial version.

Shenzhen SOFARSOLAR Co., Ltd

Location: 11/F., Gaoxinqi Technology Building, No.67 Area, Xingdong Community, Xin' an Sub-district, Bao' an District, Shenzhen City,China

Postcode: 518000

Company Website: www.sofarsolar.com

Email: service@sofarsolar.com

● **Outline**

This manual is an integral part of SOFAR25~50KTLX-G3. It describes the assembly, installation, commissioning, maintenance and failure of the product. Please read it carefully before operating.

● **Scope of Validity**

This manual contains important instructions for:





- | | | |
|---------------------------|------------------------|---------------------------|
| SOFAR 25KTLX-G3 | SOFAR 30KTLX-G3 | SOFAR 30KTLX-G3-A |
| SOFAR 33KTLX-G3 | SOFAR 36KTLX-G3 | SOFAR 40KTLX-G3 |
| SOFAR 45KTLX-G3 | SOFAR 50KTLX-G3 | SOFAR 40KTLX-G3-HV |
| SOFAR 50KTLX-G3-HV | | |

● **Target Group**

This manual is for qualified electricians. The tasks described in this manual only can be performed by qualified electricians.

● **Symbols Used**

The following types of safety instruction and general information appear in this document as described below:

	“ Danger ” indicates a hazardous situation which, if not avoided, will result in death or serious injury.
Danger	
	“ Warning ” indicates a hazardous situation which, if not avoided, could result in death or serious injury
Warning	
	“ Caution ” indicates a hazardous situation which, if not avoided, could result in minor or moderate injury
Caution	
	“ Attention ” indicates there are potential risks, if fail to prevent, may lead to equipment cannot normally or property damage.
Attention	
	“ Note ” provides additional information and tips that are valuable for the optimal operation of the product.
Note	

1. Basic Safety Information

Outlines of this Chapter

Please read the instruction carefully. Faulty operation may cause serious injury or death.

	If you have any question or problem when you read the following information, please contact Shenzhen SOFARSOLAR CO., Ltd.
Note	

Safety Instruction

Introduce the safety instruction during installation and operation of SOFAR 25~50KTLX-G3

Symbols Instruction

This section gives an explanation of all the symbols shown on the inverter and on the type label.

1.1. Requirement for Installation and

Maintenance

Installation of SOFAR 25~50KTLX-G3 on-grid inverter must conform with laws, regulations, codes and standards applicable in the jurisdiction.

Before installing and adjusting the produce, please read all of instructions, cautions and warnings in this manual

Before connecting the product to the electrical utility grid, contact the local utility company for allowance. Also, this connection must be made only by qualified electrician.

If the failure persists, please contact the nearest authorized maintenance center. If you don't know which service center is closest to you, please contact your local distributor. Don't repair the product by yourself, which may lead serious injury or damage.

Qualified Person

When inverter is working, it contains lethal voltages and went hot in some area. Improper installation or maloperation could cause serious damage and injury. To reduce the risk of personal injury and to ensure the safe installation and operation of the product, only a qualified electrician is allowed to execute transportation, installation, commissioning and maintenance. Shenzhen SOFARSOLAR Co, Ltd does not take any responsibility for the property destruction and personal injury because of any incorrect use.

Label and Symbols

SOFAR 25~50KTLX-G3 has type label attach the side of product which contact important information and technical data, the type label must permanent attached to the product.

SOFAR 25~50KTLX-G3 has warning symbol attached the product which contact information of safety operation. The warning symbol must permanent attached to the product.

Installation location requirement

Please install the inverter according to the following section. Place inverter in an appropriate bearing capacity objects (such as solid brick wall, or strength equivalent mounting surface, etc.) and make sure inverter vertical placed. A proper installation location must have enough space for fire engine access in order for maintenance if faulty occur. Ensure the inverter is installed in a wall ventilated environment and have enough air-cooling cycle. Air humidity should less than 90%.

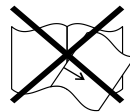
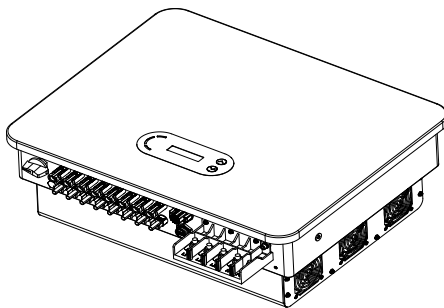



Transportation Requirement

Inverter is in the good electrical and physical condition when it ship out from factory. During transport, inverter must be placed in its original package or other proper package. Transportation company should responsible for any damage during transport period.



If you find any packing problems that may cause the damage of inverter or any visible damage, please notice the responsible transportation company immediately. You can ask your installer or SOFARSOLAR for help is necessary.

Electrical Connection



Please comply with all the current electrical regulations about accident prevention in dealing with the current inverter.

	<p>Before the electrical connection, use opaque material to cover the PV modules or disconnect PV string DC switch. PV arrays will produce dangerous voltage if it is exposure under sun</p>
<p style="background-color: red; color: white; padding: 2px;">Danger</p>	
	<p>All operation must accomplish by certified electrical engineer</p> <ul style="list-style-type: none"> ● Must be trained; ● Completely read the manual operation and understand all information
<p style="background-color: orange; color: white; padding: 2px;">Warning</p>	
	<p>Must get permission by local utility company before connecting to grid and the connection must be done by certified electrical engineers</p>
<p style="background-color: blue; color: white; padding: 2px;">Attention</p>	

Operation

	<p>Touching the utility grid or the terminal conductors can lead to lethal electric shock or fire!</p> <p>Do not touch non-insulated cable ends, DC conductors and any live components of the inverter.</p>
<p style="background-color: red; color: white; padding: 2px;">Danger</p>	<p>Attention to any electrical relevant instruction and document.</p>
	<p>Enclosure or internal components may get hot during operation. Do not touch hot surface or wear insulated gloves.</p>
<p style="background-color: blue; color: white; padding: 2px;">Attention</p>	

Maintenance and repair

 Danger	<p>Before any repair work, turn OFF the AC circuit breaker between the inverter and electrical grid first, then turn OFF the DC switch. After turning OFF the AC circuit breaker and DC switch wait for at least 5 minutes before carry any maintenance or repair work.</p>
 Attention	<p>Inverter should not work again until removing all faults. If any repair work is required, please contact local authorized service center. Should not open the inverter cover without authorized permit, SOFARSOLAR does not take any responsibility for that.</p>



EMC/Noise Level



Electromagnetic compatibility (EMC) refers to that on electrical equipment functions in a given electromagnetic environment without any trouble or error, and impose no unacceptable effect upon the environment. Therefore, EMC represents the quality characters of an electrical equipment.

- The inherent noise-immune character: immunity to internal electrical noise
- External noise immunity: immunity to electromagnetic noise of external system
- Noise emission level: influence of electromagnetic emission upon environment

 Danger	<p>Electromagnetic radiation from inverter may be harmful to health! Please do not continue to stay away from the inverter in less than 20cm when inverter is working</p>
---	---





1.2. Symbols and signs





 Danger	<p>High voltage of inverter may be harmful to health! Only certified engineer can operate the product; Juveniles, Disable, should not use this product; Keep this product out of the reach of children;</p>
 Caution	<p>Caution of burn injuries due to hot enclosure! Only touch the screen and pressing key of the inverter while it is working</p>

	PV array should be grounded in accordance to the requirements of the local electrical grid company
Attention	
	Ensure the maximum DC voltage input is less than the maximum inverter DC voltage (including in low temperature condition). Any damage cause by overvoltage, SOFARSOLAR will not take the responsibility including warranty
Warning	

Signs on the Product and on the Type Label

SOFAR 25~50KTLX-G3 has some safety symbols on the inverter. Please read and fully understand the content of the symbols before installation.

Symbols	Name	Explanation
	This is a residual voltage in the inverter!	After disconnect with the DC side, there is a residual voltage in the inverter, operator should wait for 5 minutes to ensure the capacitor is completely discharged.
	Caution of high voltage and electric shock	The products operates at high voltages. Prior to performing any work on the product, disconnect the product from voltage sources. All work on the product must be carried out by qualified persons only.
	Caution of hot surface	The product can get hot during operation. Avoid contact during operation. Prior to performing any work on the product, allow the product to cool down sufficiently
	Comply with the Conformite Euroeenne (CE) Certification	The product complies with the CE Certification
	Grounding Terminal	This symbol indicates the position for the connections of an additional equipment grounding conductor

	<p>Observe the documentation</p>	<p>Read all documentation supplied with the product before install</p>
	<p>Positive pole and negative pole</p>	<p>Positive pole and negative pole of the input voltage (DC)</p>
	<p>Temperature</p>	<p>Indicated the temperature allowance range</p>
	<p>RCM logo</p>	<p>RCM (Regulatory Compliance Mark) The product complies with the requirements of the applicable Australian standards.</p>

2. Product Characteristics

Outlines of this Chapter

Product Dimensions

Introduce the field of use and the dimensions of the product

Function Description

Introduce working principle and internal components of the product

Efficiency Curves

Introduce the efficiency curves of the product

2.1. Intended Use

Field of use

SOFAR25~50KTLX-G3 is a transformer-less on grid PV inverter, that converts the direct current of the PV panels to the grid-compliant, three-phase current and feeds into the utility grid.

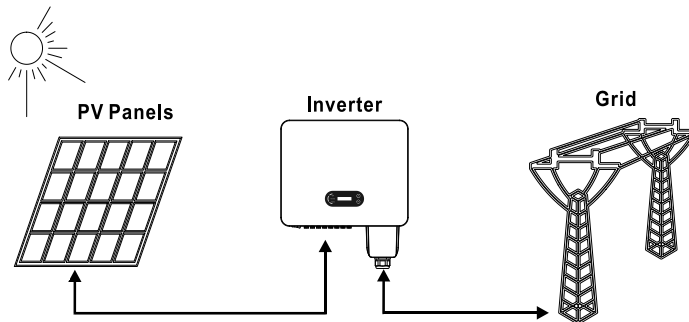

Figure 2-1PV Grid-Tied System

SOFAR 25~50KTLX-G3 may only be operated with PV arrays (photovoltaic module and cabling) for on grid condition. Do not use this product for any other or additional purposes. Any damage or property loss due to any use of the product other than described in this section, SOFARSOLAR will not take the responsibility. DC input of the product must be PV module, other source such like DC sources,

batteries will against the warranty condition and SOFARSOLAR will not take the responsibility.

Intended grid types

SOFAR25~50KTLX-G3 configurations. For the TT type of electricity grid, the voltage between neutral and earth should be less than 30V. Inverters are compatible with TN-S, TN-C, TN-C-S, TT, IT grid.

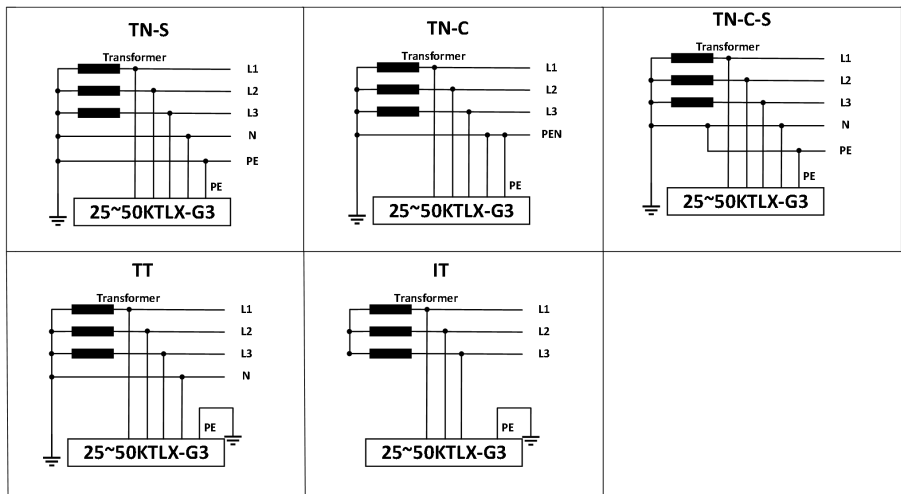

Figure2-2 Overview of the grid configurations

Product Dimensions

The choice of optional parts of inverter should be made by a qualified technician who knows the installation conditions clearly.

Dimensions Description

◆ SOFAR

25KTLX-G3,30KTLX-G3,30KTLX-G3-A,33KTLX-G3,36KTLX-G3,40KTLX-G3,45KTLX-G3,50KTLX-G3,40KTLX-G3-HV,50KTLX-G3-HV

L×W×H=585*480*220mm

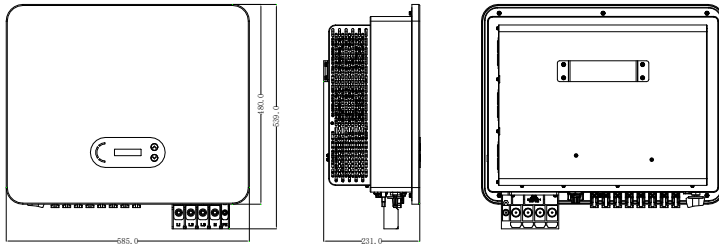

Figure 2-3 Front, side and back of the machine (take 50KW for example)

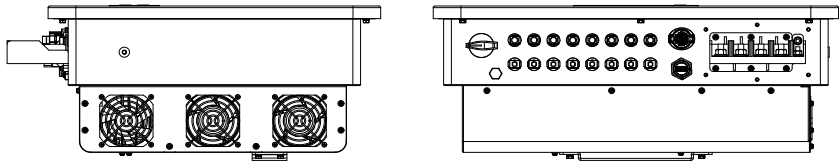

Figure 2-4 Bottom view (take 50KW for example)

Note: 25~36K and 40K-HV supports 6-channel PV string input, 40~50K and 50K-HV supports 8-channel PV string input.

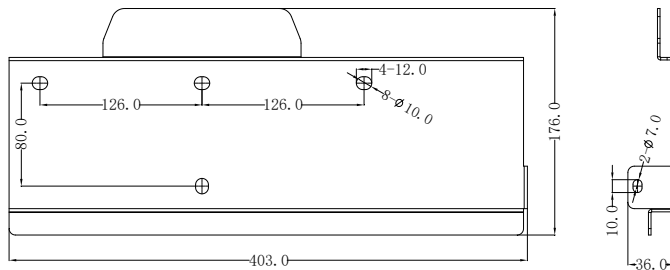
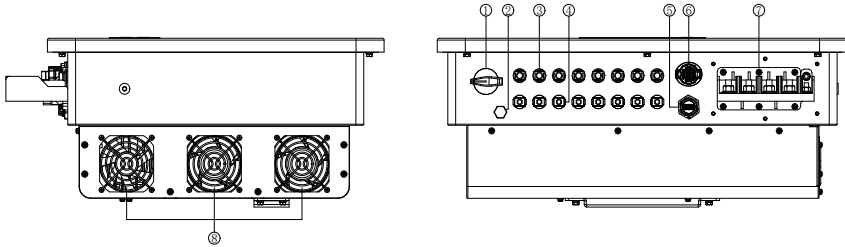

Figure 2-5 bracket dimensions (take 50KW for example)

Function description of inverter box bottom



1. DC Switch	5. USB Port (for WIFI or Ethernet communication)
2. Breather valve	6. COM Port (for RS485 communication)
3. DC positive poles connectors	7. AC output
4. DC negative poles connectors	8. Fans

Figure 2-6Bottom view of the SOFAR 25~50KTLX-G3

Labels on the equipment

Note: label must NOT be hidden with objects and extraneous parts (rags, boxes, equipment, etc.); they must be cleaned regularly and kept visible at all times.

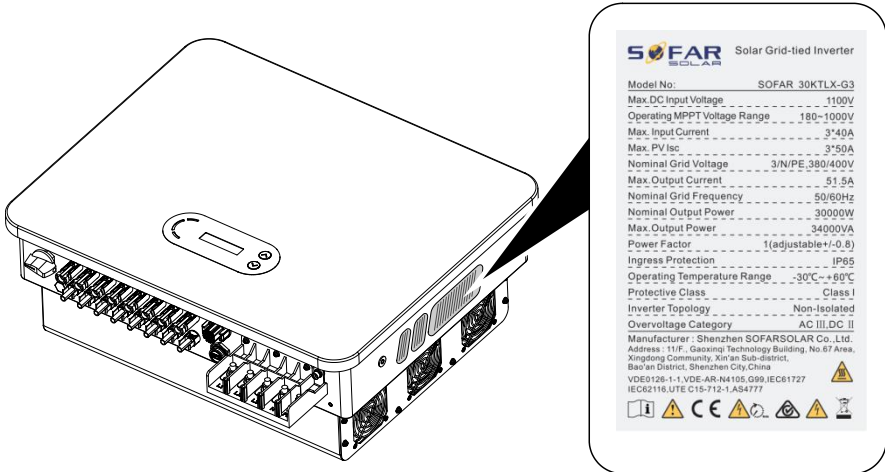

Figure 2-7 Product label

2.2. Function Description

DC power generated by PV arrays is filtered through Input Board then enter Power Board. Input Board also offer functions such as insulation impedance detection and input DC voltage/ current detection. DC power is converted to AC power by Power Board. AC power is filtered through Output Board then AC power is fed into the grid. Output Board also offer functions such as grid voltage/ output current detection, GFCI and output isolation relay. Control Board provides the auxiliary power, controls the operation state of inverter and shows the operation status by Display Board. Display Board displays fault code when inverter is abnormal operation conditions. At the same time, Control Board can trigger the replay to protect the internal components.

Function Module

A. Energy management unit

Remote control to start/ shunt down inverter through an external control

B. Feeding reactive power into the grid

The inverter is able to produce reactive power thus to feed it into the grid through the setting of the phase shift factor. Feed-in management can be controlled directly by APP or through a RS485 interface.

C. Limited the active power fed into grid

If enable the limited of active power function, inverter can limit the amount of active power fed into the grid to the desired value (expressed as percentage)

D. Self-power reduction when grid is over frequency

If grid frequency is higher than the limited value, inverter will reduce the output power to ensure the grid stability

E. Data transmission

Inverter or a group of inverters can be monitored remotely through an advanced communication system based on RS485 interface or via USB port.

F. Software update

USB interface for uploading the firmware, remotely uploading by using USB acquisition stick (WIFI or Ethernet) is also available.

2.3. Electrical block diagram

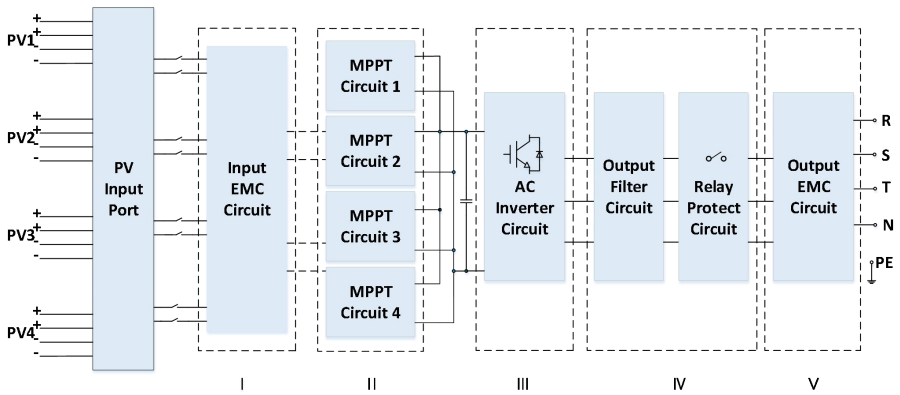

Figure 2-8 Schematic diagram(take 50KW for example)

2.4. Efficiency and derating curve

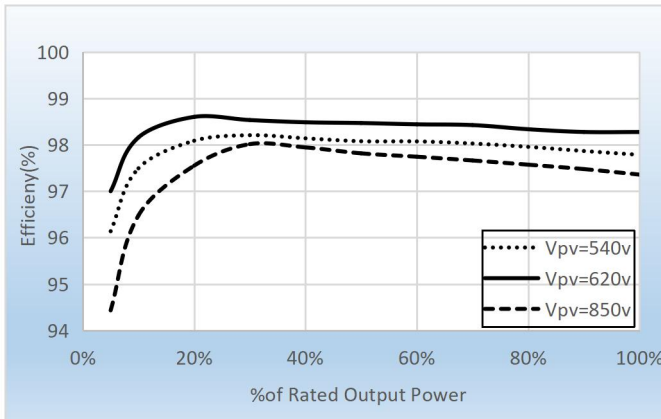

Figure 2-9 Power efficiency curve (take 50KW for example)

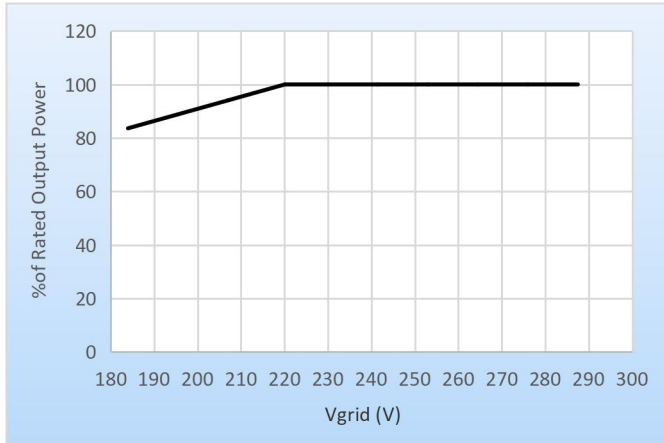





Figure 2-10 Rated Power ratio vs Grid Voltage

3. Installation

Outlines of this Chapter

This topic describes how to install this product, please read carefully before install.

	Do NOT install the product on flammable material Do NOT store this product in potentially explosive atmospheres
Dangers	
	The enclosure and heat sink will get hot during operation, please do not mount the product at a easy to reach location
Caution	
	Consider the weight of this product when doing transport and moving Choose an appropriate mounting position and surface At least two persons for installation
Attention	

3.1. Installation Process

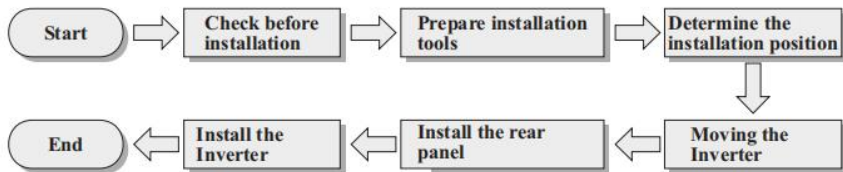

3.2. Checking Before Installation



Checking Outer Packing Materials





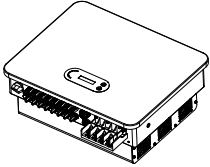
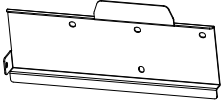
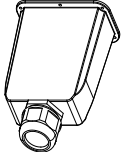

Before unpacking, please check the condition of the outer package materials if any damaged found, such as holes, cracks, please not unpack the product, contact your distributor immediately. Recommend installing the product within 24 hours after unpacking the package.

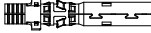
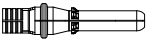

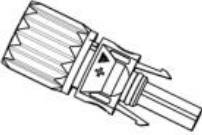
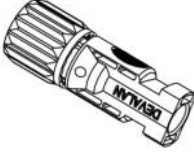
Checking Deliverable

After unpacking, please check according to following table, to see whether all the parts were included in the packing, please contact your distributor immediately if anything missing or damage.

Figure 3-1 Components and mechanical parts that inside the package

No	Pictures	Description	Quantity
1		SOFAR 25~50KTLX-G3	1 PCS
2		Rear Panel	1 PCS
3		AC waterproof cover	1 PCS
4		M8*80 Hexagon screws	4 PCS
5		PV+ metal pin	25~36KTLX-G3 6PCS 40~50KTLX-G3 8PCS 40KTLX-G3-HV 6PCS 50KTLX-G3-HV 8PCS
6		PV- metal pin	25~36KTLX-G3 6PCS 40~50KTLX-G3 8PCS 40KTLX-G3-HV 6PCS 50KTLX-G3-HV 8PCS

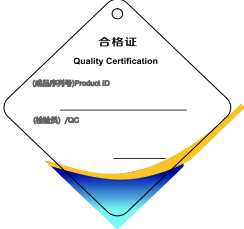
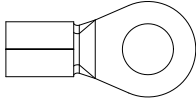
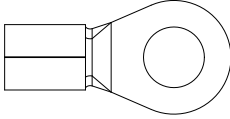
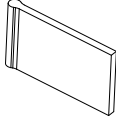
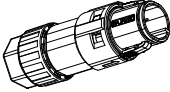

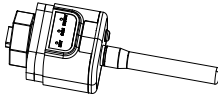



7		PV+ input connector	25~36KTLC-G3 6PCS 40~50KTLC-G3 8PCS 40KTLC-G3-HV 6PCS 50KTLC-G3-HV 8PCS
8		PV- input connector	25~36KTLC-G3 6PCS 40~50KTLC-G3 8PCS 40KTLC-G3-HV 6PCS 50KTLC-G3-HV 8PCS
9		M4 cross screw (For locking the waterproof cover)	6PCS
10		M5 cross screw (For locking the rear panel)	1PCS
11		M6 Hexagon screws	1PCS
12		Manual	1PCS
13		Warranty Card	1PCS



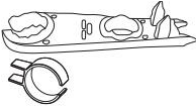
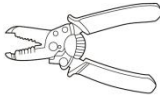

14		Quality Certificate	1PCS
15		R-type terminal (Connect PE)	1PCS
16		R-type terminal (Connect L1/L2/L3/N)	4PCS
17		AC terminal insulation partition	4PCS
18	 <p style="text-align: center;">Or</p> 	Communication Terminal	1PCS
19		USB acquisition stick (WIFI/Ethernet)	1 PCS (Optional)

3.3. Tools

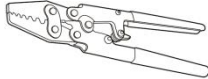
Prepare tools required for installation and electrical connection as following table:

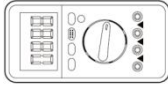
Figure 3-2 Installation tools

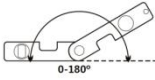
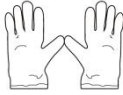
No	Tool	Description	Function
1		Hammer Drill Recommend drill @ 6mm	Used to drill holes on the wall
2		Screwdriver	Use to tighten and loosen screws when installing AC power cable Use to remove AC connectors from the product
3		Socket wrench	Fasten the cable and Install the expansion bolt
4		Hammer	Install the expansion bolt
5		Removal Tool	Remove PV Connector
6		Wire Stripper	Used to peel cable
7		M6 hexagon wrench	M6 use to uninstall and install the front top cover and down cover
8		Crimping Tool	Use to crimp cable on grid side, load side and CT extensive cable

9		Multimeter	Check grounding cable, PV positive and negative pole
10		Marker	Mark signs
11		Measuring Tape	Measure distance
12		Level	Ensure the rear panel is properly installed
13		ESD gloves	Installer wear when installing product
14		Safety goggles	Installer wear when installing product
15		Mask	Installer wear when installing product

3.4. Determining the Installation Position

Select an appropriate location to install the product to make sure the inverter can work in a high efficiency condition. When selecting a location for the inverter, consider the following:

Note: install vertical or backward tilt within 0-15°, Do not install forward or upside down!

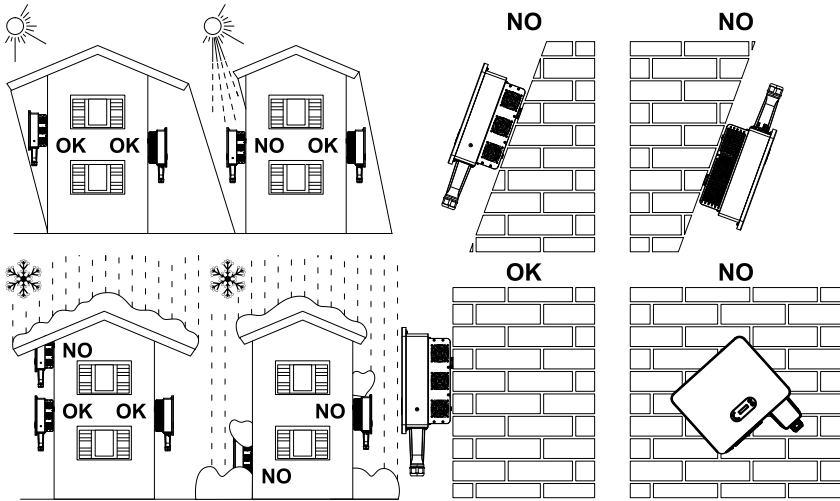

Figure 3-1 Installation Position Selection

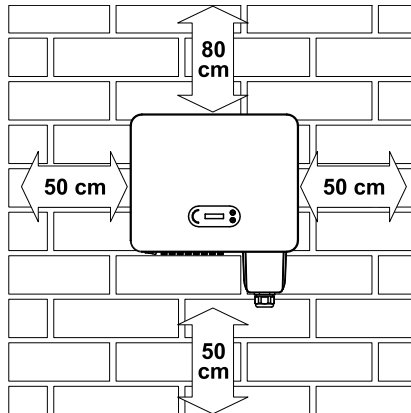

Figure 3-2 Clearance for single inverter

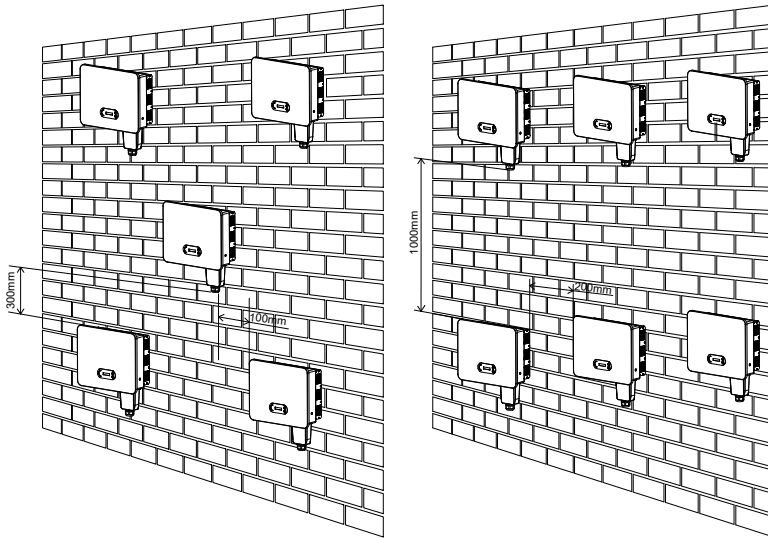

Figure 3-3 Clearance for multiple inverters

3.5. Moving of inverter

Unload the inverter from package, horizontally move to the install position. When open the package, at least two operators insert the hands to the back of heat sink part.

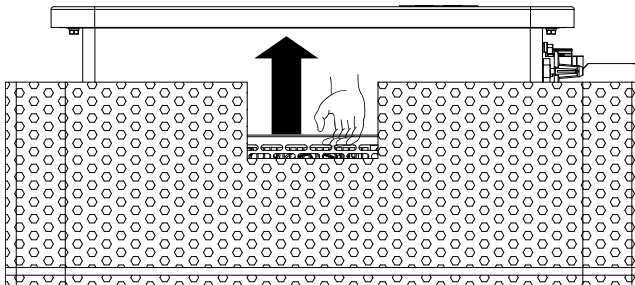

Figure 3-4 Move inverter from package (1)

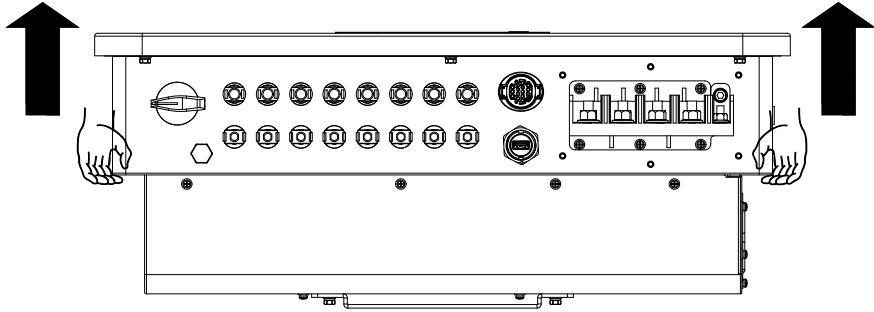

Figure 3-5 Move inverter from package (2)

	<p>Inverter is heavy, attention to keep the balance when lift the inverter. Dropped while being transported may cause injuries.</p>
	<p>Do not put the inverter with wiring terminals contacting the floor because the power ports and signal ports are not designed to support the weight of the inverter</p>
<p>Attention</p>	<p>When place inverter on the floor, put it above foam or paper to avoid the damage of the shell of inverter.</p>

3.6. Installation

Step 1: Placed the rear panel on the mounting wall, determine the mounting height of the bracket and mark the mounting poles accordingly. Drilling holes by using Hammer Drill, keep the hammer drill perpendicular to the wall and make sure the position of the holes should be suitable for the expansion bolts.

Step 2: Insert the expansion bolt vertically into the hole;

Step 3: Align the rear panel with the hole positions, fix the rear panels on the wall by tightening the M8*80 Hexagon screws

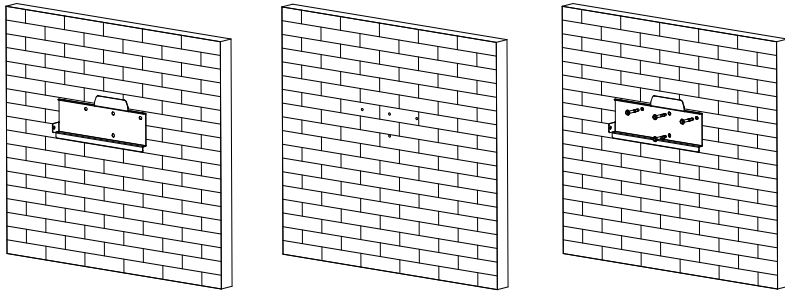

Figure 3-6 Installation instruction (1)

Step 4: Lift the inverter and hang it on the rear panel, and fixing both side of inverter with M6 screw (accessories).

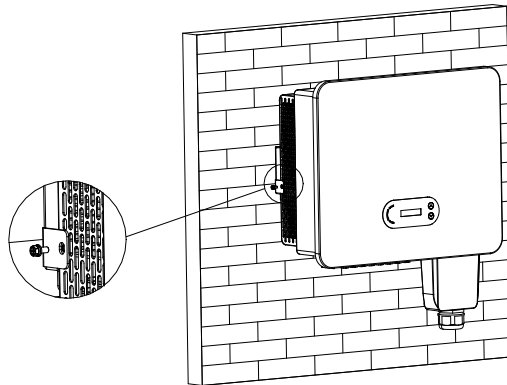

Figure 3-7 Installation instruction (2)



4. Electrical Connection

Outlines of this Chapter

This section introduces the electrical connection for the product. Please read the information carefully, it may helpful to understand the grounding wiring, DC input connection, AC output connection and communication connection.

Caution:

Before performing electrical connections, ensure the DC switch is OFF and AC circuit breaker is OFF. Waiting 5 minutes for the capacitor to be electrically discharged.

	Installation and maintenance should be done by certified electrical engineer
Attention	
	Before the electrical connection, use opaque material to cover the PV modules or disconnect PV string DC switch. PV arrays will produce dangerous voltage if it is exposure under sun
Danger	
	For this product, the open circuit voltage of PV strings should not greater 1100V
Note	

The connected panel must meet the standard IEC61730A.

String Model	IscPV(maximum)	Maximum output current (A)
SOFAR 25KTLX-G3	3*50A	42.4A
SOFAR 30KTLX-G3		51.5A
SOFAR 30KTLX-G3-A		45.3A
SOFAR 33KTLX-G3		56A

SOFAR 36KTLX-G3		60.6A
SOFAR40KTLX-G3	4*50A	66.7A
SOFAR 45KTLX-G3		75.8A
SOFAR 50KTLX-G3		83.3A
SOFAR40KTLX-G3-HV	3*50A	53A
SOFAR 50KTLX-G3-HV	4*50A	66.2A

4.1. Electrical Connection

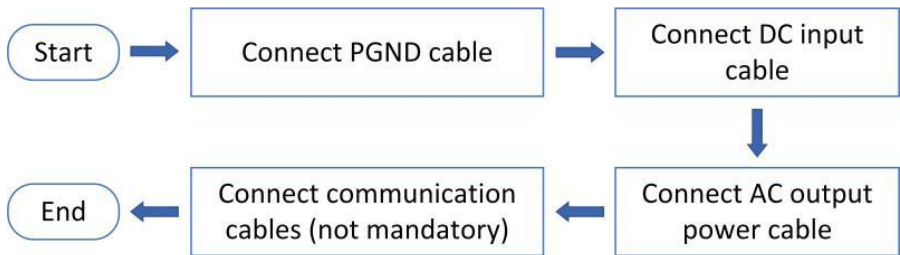



Figure 4-1flowchart for connecting cables to the inverter

4.2. Grounding Connection (PE)

Connect the inverter to the grounding electrode using ground cable

	<p>SOFAR 25~50KTLX-G3 is a transformerless inverter which requires the positive pole and negative pole of the PV array are NOT grounded. Otherwise, it will cause inverter failure. In the PV system, all non-current-carrying metal parts (such as mounting frame, combiner box enclosure, etc.) should be connected to earthed.</p>
Note	

Preparation: prepare the grounding cable (recommend greater than 16mm² yellow-green outdoor cable, refer to section 4.3)

Procedure:

Step 1: Remove the insulation layer with an appropriate length using a wire stripper shown as figure 4-2)

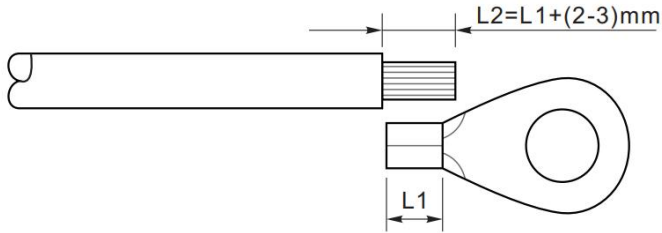

Figure 4-2 Grounding connection instruction (1)

Note: the length of L2 should 2~3mm higher than L1

Step 2: Insert the exposed core wires into the OT terminal and crimp them by using a crimping tool, as shown as figure 5.3. Recommend using OT terminal: OT-M6.

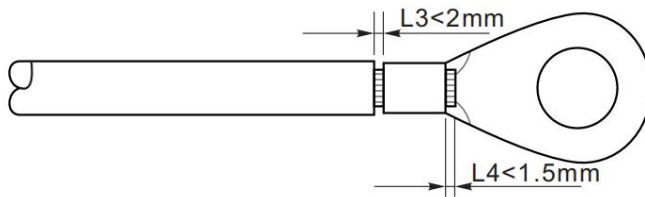

Figure 4-3 Grounding connection instruction (2)

Note 1: L3 is the length between the insulation layer of the ground cable and crimped part. L4 is the distance between the crimped part and core wires protruding from the crimped part.

Note 2: The cavity formed after crimping the conductor crimp strip shall wrap the core wires completely. The core wires shall contact the terminal closely.

Step 3: Tighten the OT terminal by using M6 screw. Recommend torque is 5-7N.m

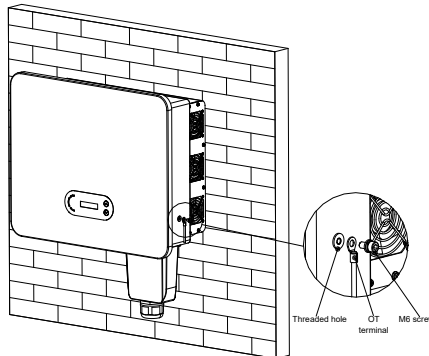



Figure 4-4 Inverter external grounding instruction diagram

4.3. Connect grid side of inverter (AC-Output)

SOFAR 25~50KTLX-G3 connect to utility grid by using AC power cable. The AC connection must meet the requirement of local grid operator

	Ban multiple Inverters use one circuit breaker Ban connect loads between inverter and circuit breaker
Caution	

Model \ Item	L/N Cross section area of Cu or Al cable (mm ²)	PE Cross section area of Cu or Al cable (mm ²)	Muti-core outdoor cable diameter (mm)	AC Circuit Breaker specification
SOFAR 25KTLX-G3	16~35	16	<50	63A/230V/3P, I Δ N=0.1A
SOFAR 30KTLX-G3	16~35	16	<50	63A/230V/3P, I Δ N=0.1A
SOFAR 30KTLX-G3-A	16~35	16	<50	63A/230V/3P, I Δ N=0.1A
SOFAR 33KTLX-G3	16~35	16	<50	80A/230V/3P, I Δ N=0.1A
SOFAR 36KTLX-G3	25~50	16~25	<50	80A/230V/3P, I Δ N=0.1A
SOFAR 40KTLX-G3	25~50	16~25	<50	100A/230V/3P, I Δ N=0.1A
SOFAR 45KTLX-G3	35~70	16~35	<50	100A/230V/3P, I Δ N=0.1A
SOFAR 50KTLX-G3	35~70	16~35	<50	120A/230V/3P, I Δ N=0.1A

SOFAR 40KTLX-G3-HV	25~50	16~25	<50	80A/380V/3P, I△N=0.1A
SOFAR 50KTLX-G3-HV	35~70	16~35	<50	100A/380V/3P, I△N=0.1A

Must use five core outdoor cable, the recommend AC cable and Residual current breaker (RCD) as below table:

If one is required under local regulations, SOFAR recommends a type A or B RCD with sensitivity of 100mA or higher.

Where local electricity code requires an RCD with a lower leakage ratings, the discharge current might result in nuisance tripping of the external RCD. Sofar recommends the following measure in selecting an external RCD to avoid nuisance tripping:

- 1: Selecting appropriate RCD.
- 2: Configure the trip current of inverter internal RCD to a lower value that the trip current of the external RCD.

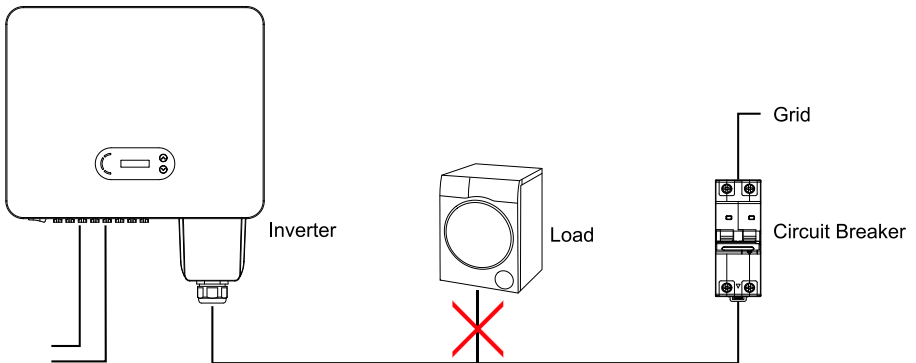

Figure 4-5 Incorrect connection between load and inverter

The resistance at connection point must less than 2Ω . In case to have a properly anti-islanding function, please choose the high-quality PV cable and ensure the power loss is less than 1%. Meanwhile, the inverter AC side to grid connection point must less than 100m. the relation between cable length, cross section area

and power loss as below:

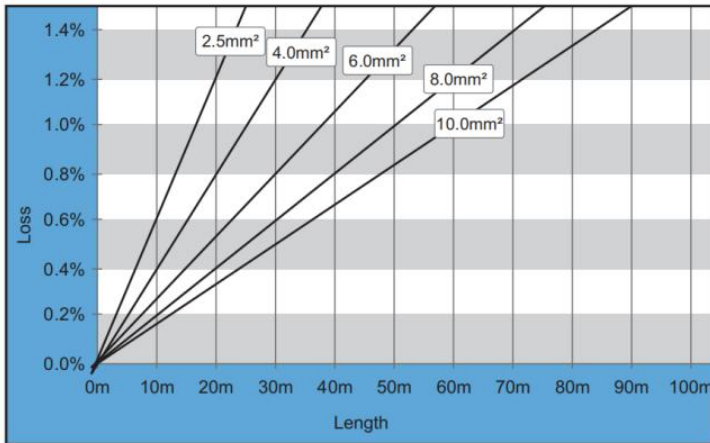

Figure 4-6 relation between cable length, cross section area and power loss

The AC output terminal of this product is equipped with high current 5-core terminal block and customized AC output waterproof cover, which can meet the IP65 level requirements after installation. AC cable need customer self connect:

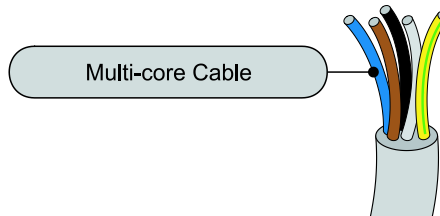

Figure 4-7Theequipment Multi-core Cable

Wiring Procedure as following:

Step 1: Select the appropriate cable diameter according to table 4-1, process the cable according to the following picture size requirements, and then pass through PG waterproof joint;

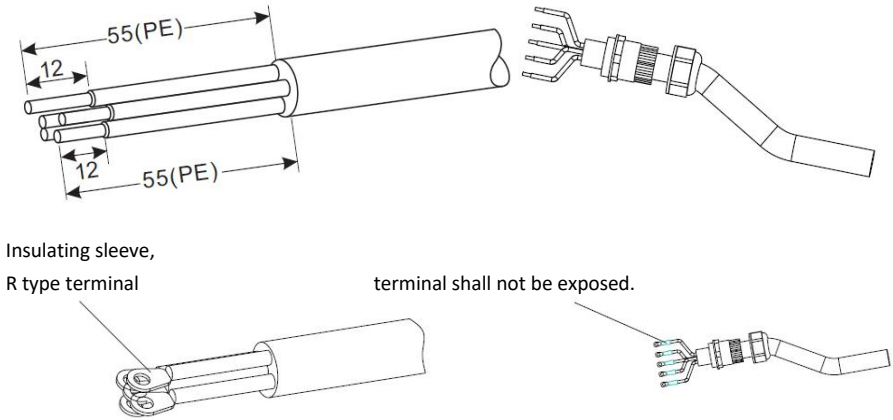

Figure 4-8 AC cable connection instruction diagram (1)

Step 2: After assembling the PG waterproof connector, connect the cable to the AC terminal block L1, L2, L3, N, PE contacts, and tighten the M8 screws (6-10 N.m) and M6 screws (5-7 N.m) with a sleeve; Install AC shield screws(2~3 N.m);

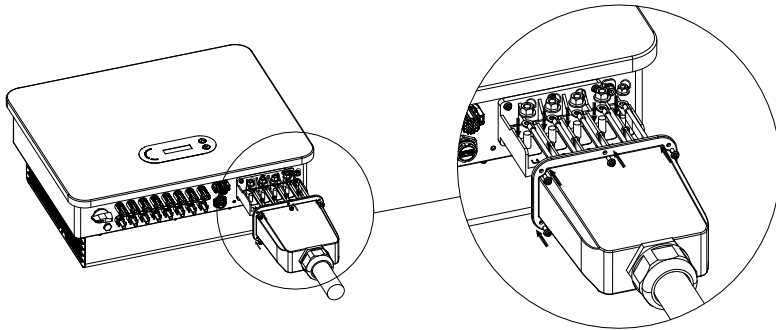

Figure 4-9 AC cable connection instruction diagram (2)

Note: Copper/aluminum conversion terminal is required when aluminum wire is used, which is delivered with the copper terminal.

4.4. Connect PV side of inverter(DC-Input)

Table 4.2 recommend DC input cable size (maximum tolerance voltage $\geq 1100V$ PV

cable)

Copper cable cross section area (mm ²)	Cable OD (mm)
2.5~6.0	6.0~9.0

Step 1:

Figure 5-2 Recommend DC cable size

Step1: Find the metal contact pins in the accessories bag, connect the cable according below diagram (1.Positive cable, 2. negative cable);

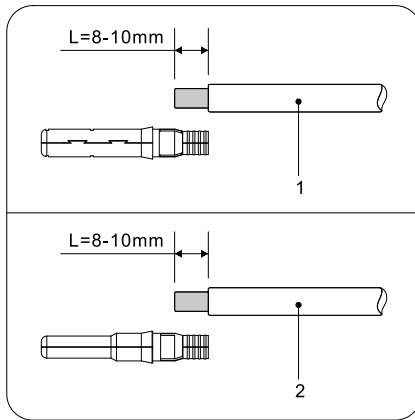

Figure 4-10 DC cable connection (1)

Step 2: Crimp the PV metal contact pin to the striped cable using a proper crimping pliers;

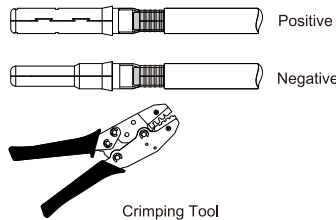

Figure 4-11 DC cable connection(2)

Step 3: Insert wire into the connector cap nut and assemble into the back of male or female plug, When you heard a “click”, the pin tact assembly is seated correctly. (3. Positive Connector, 4. negative connector);

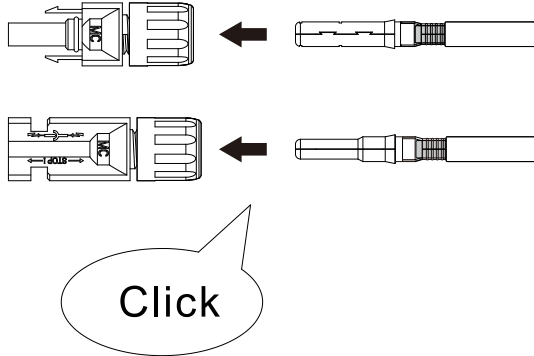

Figure 4-12 DC cable connection(3)

Step 4: Measure PV voltage of DC input with multimeter, verify DC input cable polar and connect DC connector with inverter until hearing a slight sound indicated connection succeed.

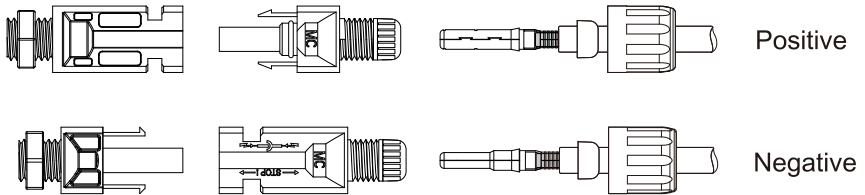

Figure 4-13 DC cable connection(4)

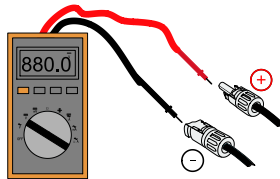

Figure 4-14 Use a multimeter to check the positive and negative electrodes

Note : Please use multimeter to make sure the PV array positive pole and negative pole!

Dealing : If need to remove the PV connector from inverter side, please use the Removal Tool as below diagram, move the connector gently.



NOTE

Before, moving the positive and negative connector, please make sure "DC Switch" is on OFF position.

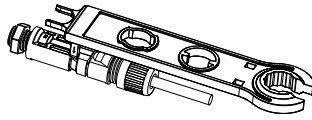

Figure 4-15 Removal DC connector

4.5. Communication Connection



Note

When layout the wiring diagram, please separate the communication wiring and power wiring in case the signal be affected.

SOFAR 25~50KTLX-G3 inverter has one USB Port and one COM Port, as shown in the following figure.

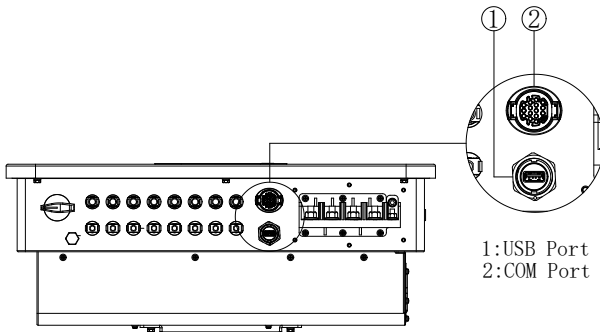

Figure 4-16 Communication connection Port

4.5.1. USB Port

Port Description:

USB port	USB flash disk access	Use for updating the software
	USB acquisition stick (WIFI or Ethernet) access	Use for remote data acquisition and upgrading of inverter

Procedure:

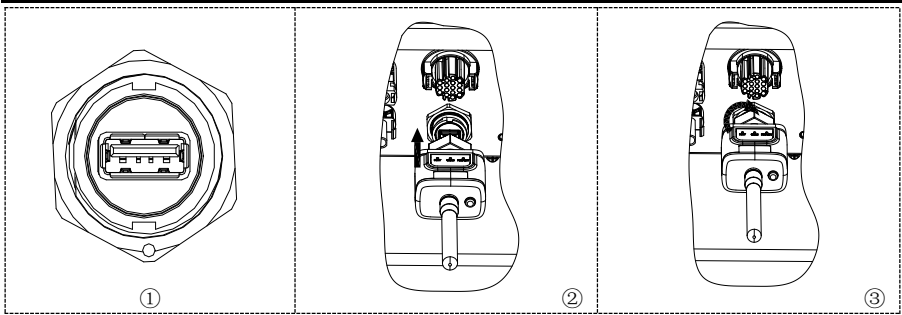

For details, please refer to the user manual of USB acquisition stick.

4.5.2.COM—Multi function communication port

Figure 4-18 Recommend COM cable size

Name	Type	Outer diameter (mm)	Area (mm ²)
RS485 Communication Wire	Outdoor shielded twisted pair meets local standards	2 or 3core: 4~8	0.25~1

Port Description :

PIN	Define	Function	Note
1	RS485A	RS485 signal+	Wire connection monitoring or multiple inverter monitoring
2	RS485A	RS485 signal+	
3	RS485B	RS485 signal-	
4	RS485B	RS485 signal-	
5	Electric meter RS485A	Electric meter RS485 signal+	Wire connection Electric meter
6	Electric meter RS485B	Electric meter RS485 signal-	
7	GND.S	Communication ground	As RS485 signal ground or DRMS port ground
8	DRM0	Remote shunt down	DRMS port
9	DRM1/5	DRMS port logical IO	

10	DRM2/6		
11	DRM3/7		
12	DRM4/8		
13-16	Blank PIN	N/A	N/A

Procedure: (Subject to the real object)

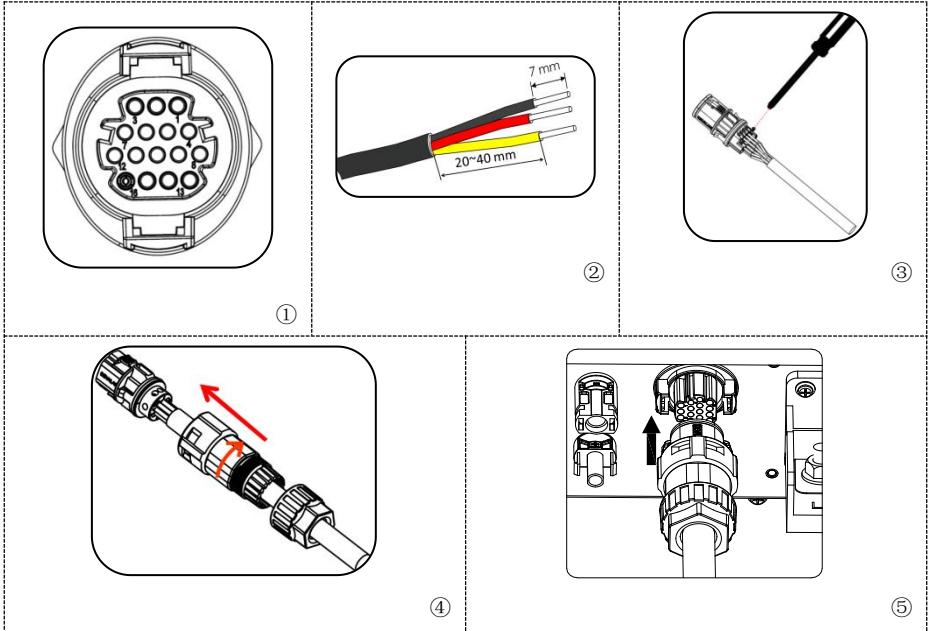

Procedure(Corresponding to the second communication terminal):

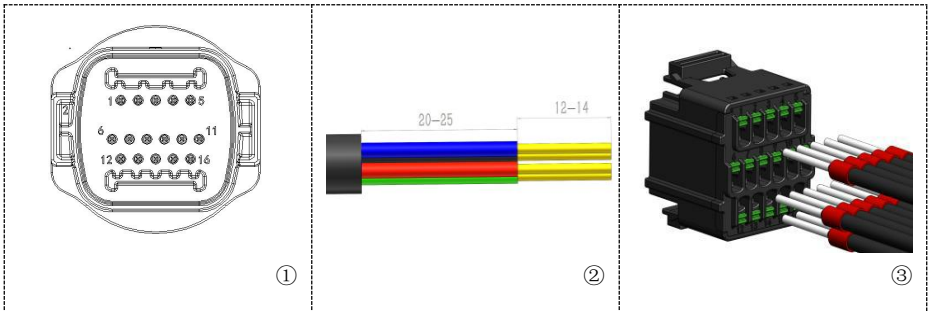

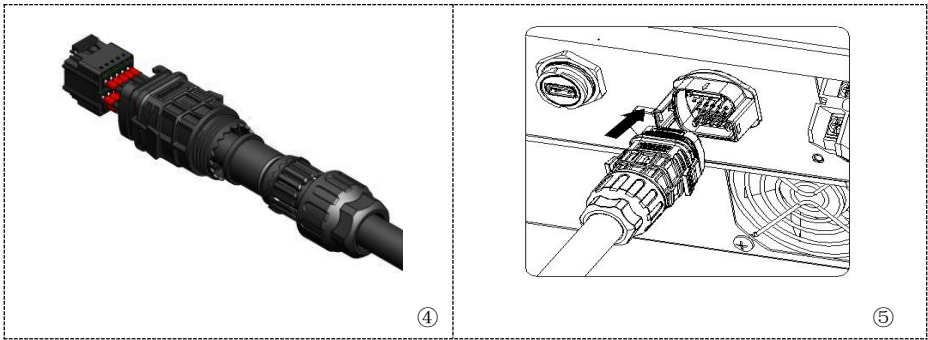

4.5.3. Communications Port Description

Logic interface

(a) Logic interface for AS/NZS 4777.2:2020, also known as inverter demand response modes (DRMs).

The inverter will detect and initiate a response to all supported demand response commands within 2 s. The inverter will continue to respond while the mode remains asserted.

Pin NO.	Function
9	DRM1/5
10	DRM2/6
11	DRM3/7
12	DRM4/8
7	GND
8	DRM0

Table 5-4 Function description of the DRMs terminal

NOTE: Supported DRM command: DRM0, DRM5, DRM6, DRM7, DRM8.

(b) Logic interface for VDE-AR-N 4105:2018-11, is in order to control and/or limit the inverter’s output power.

The inverter can be connected to a RRCR (Radio Ripple Control Receiver) in order to dynamically limit the output power of all the inverters in the installation.

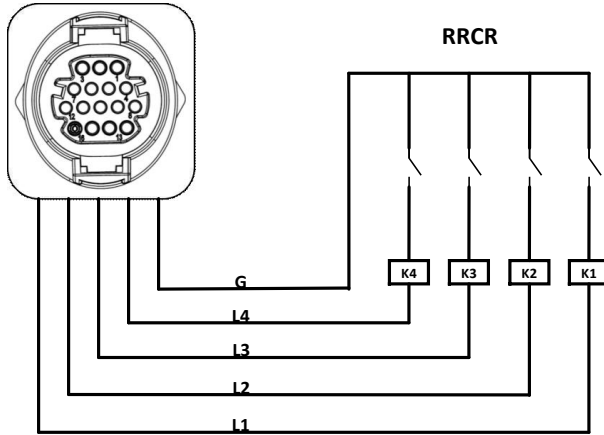

Figure 5- 18 Inverter – RRCR Connection

Pin NO.	Pin name	Description	Connected to (RRCR)
9	L1	Relay contact 1 input	K1 - Relay 1 output
10	L2	Relay contact 2 input	K2 - Relay 2 output
11	L3	Relay contact 3 input	K3 - Relay 3 output
12	L4	Relay contact 4 input	K4 - Relay 4 output
7	G	GND	Relays common node

Table 5- 5 Function description of the terminal

Relay status: close is 1, open is 0

L1	L2	L3	L4	Active Power	Cos(φ)
1	0	0	0	0%	1
0	1	0	0	30%	1
0	0	1	0	60%	1
0	0	0	1	100%	1

Table 5- 6 4 port RRCR power levels

(c) Logic interface for EN50549-1:2019, is in order to cease active power output within five seconds following an instruction being received at the input interface.

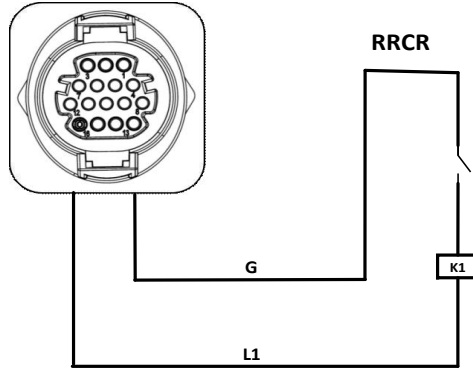

Figure 5- 19 Inverter – RRCR Connection

Pin NO.	Pin name	Description	Connected to (RRCR)
9	L1	Relay contact 1 input	K1 - Relay 1 output
7	G	GND	K1 - Relay 1 output

Table 5- 7 Function description of the terminal

Relay status: close is 1, open is 0

L1	Active Power	Power drop rate	Cos(φ)
1	0%	< 5 seconds	1
0	100%	/	1

Table 5- 8 1 port RRCR power level

(d) Insert the terminal as per the printed label, and then tighten the screws to fix the waterproof cover, rotate the cable gland clockwise to fasten it securely.

Meter/CT

PIN5 and PIN6 are used for meter communication, the electricity meter is shown in the fig.①, PIN5 and PIN6 correspond to 24,25 respectively on the electricity meter, as shown in fig.③.

The connection mode is shown in fig.②. In position. 2, 5, 8, 10 were respectively connect wires with corresponding inverter R, S and T phase and zero line is linked together, the second will be connected to the R phase CT S1 (red) received a position 1 meter, S2 (black) received the meter position. 3, in the same way connected to the S phase CT S1 (red) received the meter position. 4, position. 6 S2 (black) received the meters, S1 (red) of CT connected with T is connected to electricity meter position. 7, S2 (black) is connected to electricity meter position. 9.

NOTE: The direction of the current transformer is shown in fig.④

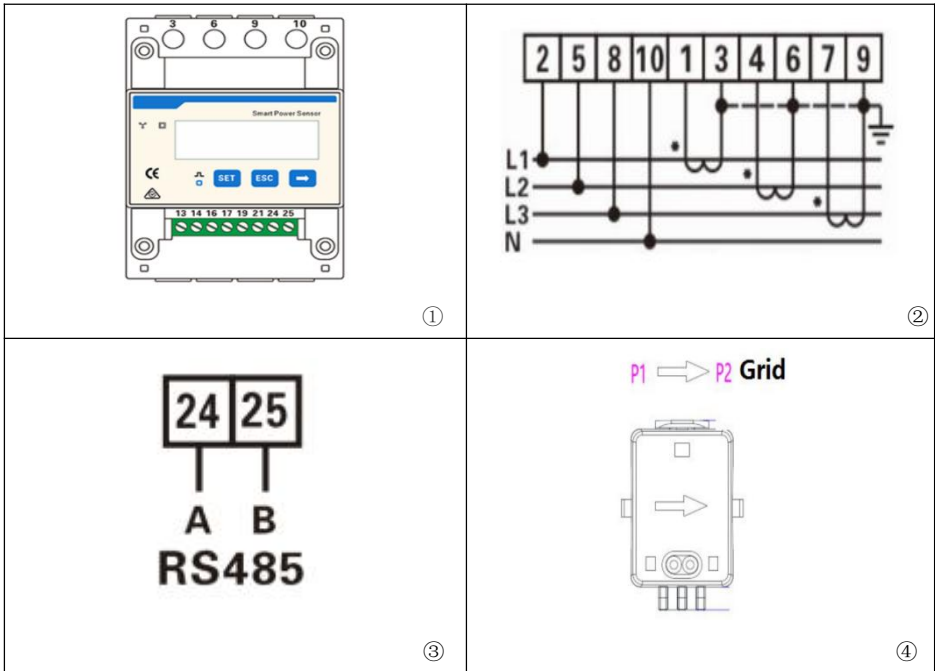

Generation and Export Limit Control functions for the inverter are available but require the use of an external measurement device to obtain grid information.

The way to obtain grid information:

Plan A: Meter + CT

Note: CT and Meter is supplied separately to the inverter. Contact manufacturer/importer/distributor to order CT and Meter.

To obtain grid information via Plan A:

Wiring according to the wiring method as shown in "Figure 5-20", and enable Anti-Reflux Power function and set the Reflux Power limit on the menu interface of the machine. Refer to <7.3 Main interface in this manual for specific operation methods.

The setting of hard anti-reverse flow is the same as that of Plan A. The electricity meter function will also need to be enabled via the menu interface of the machine. Refer to <7.3 Main interface in this manual for specific operation methods.

Please Note:

Anti-Reflux Function = Export Limit function

Reflux Power = Export apparent Power

Hard Anti-Reflux control = Hard Export limit control

Anti-Reflux Control = Soft Export limit control

When Anti-Reflux function is enabled, the reflux power of point of common coupling (PCC) will be limited to the set Reflux Power limit. Both Hard Anti-Reflux Control and Anti-Reflux Control can be used together. However, when Hard Anti-Reflux control is enabled, Anti-Reflux power limit cannot exceed the Hard Anti-Reflux power limit. If the Anti-reflux power exceeds the Hard Anti-Reflux power limit, the limit value is reported to trigger the overload protection.

When communication signal with the electricity meter is lost, the output apparent power of the inverter is limited to the value of soft export limit and does not trigger fault protection. When Hard anti reflux control is enabled, a loss of communication with the meter will trigger the inverter into a fault protection state.

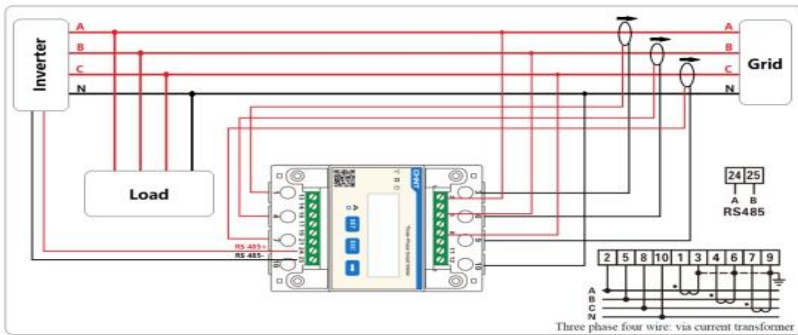

Figure 5- 20 wiring method

This topic describes the functions of the RS485 and WIFI.

RS485

By RS485 interface, transfer the inverter power output information, alarm information, operation state to the PC terminal or local data acquisition device, then uploaded to the server.

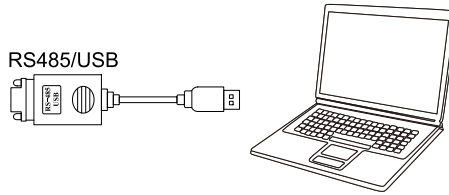

Figure 4-17 Picture of the RS485/USB converter and PC terminal

If only one SOFAR 25~50KTLX-G3 is used, use a communication cable, refer to **section 4.5.2** for COM pin definition, and choose either of the two RS485 ports.

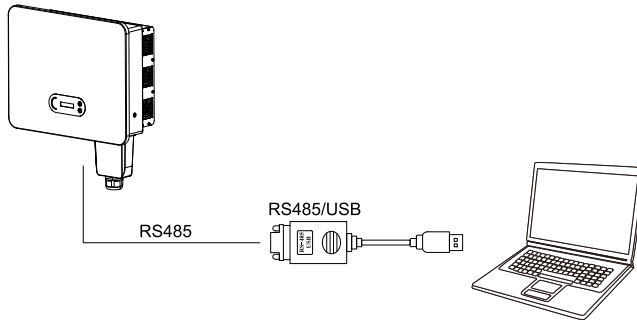

Figure 4-18 A single SOFAR 25~50KTLX-G3 connecting communications

If multiple SOFAR 25~50KTLX-G3 are used, connect all SOFAR 25~50KTLX-G3 in daisy chain mode over the RS485 communication cable. Set different Modbus address (1~31) for each inverter in LCD display.

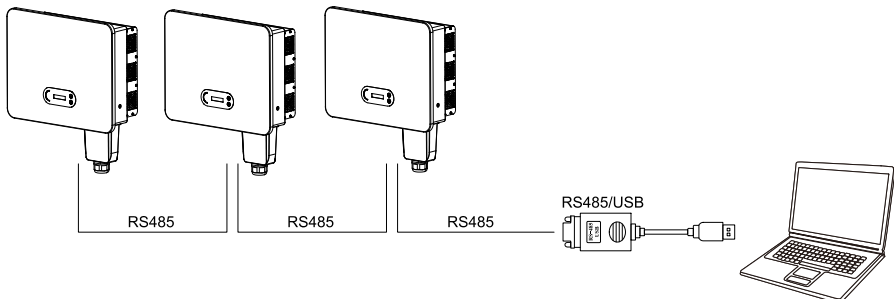

Figure 4-19 Multi SOFAR 25~50KTLX-G3 connecting Communications

Register remote monitoring of SOFAR 25~50KTLX-G3 at its relevant website or APP according to monitoring device SN.

Web: <https://home.solarmanpv.com> (Recommended browser: Chrome58、Firefox49、IE9 and above version).

APP: Android: Go to Android Market and search "SolarMAN".

IOS: Go to App Store and search "SolarMAN".

SolarMAN-3.0-Web User Manual, Please visit the

<https://doc.solarmanpv.com/web/7>.

SolarMAN-App User Manual, Please visit the <https://doc.solarmanpv.com/web/14>.

WIFI / Ethernet

By the USB acquisition stick (WIFI / Ethernet), transfer the inverter power output information, alarm information, operation state to the PC terminal or local data acquisition device, then uploaded to the server. Register remote monitoring of SOFAR 25~50KTLX-G3 at its relevant website or APP according to monitoring device SN.

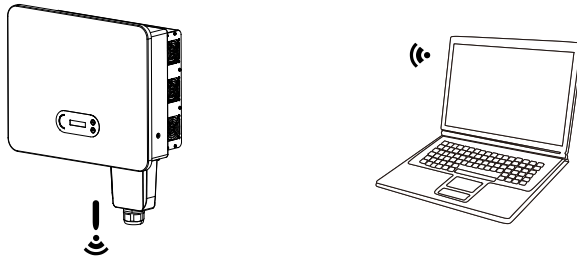

Figure 4-20 Connect one USB acquisition stick (WIFI version) to wireless router

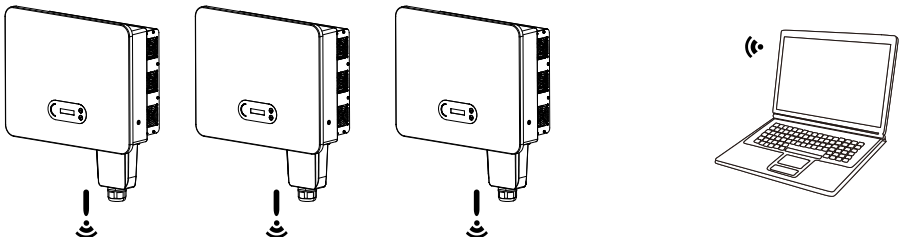



Figure 4-21 Connect multiple USB acquisition stick (WIFI version) to wireless router

	<ul style="list-style-type: none"> ● The length of the RS485 communication cable should be less than 1000 m.
<p>Note</p>	<ul style="list-style-type: none"> ● The length of the WIFI communication cable should be less than 100 m. ● If multiple SOFAR 25~50KTLX-G3 are connected to the monitoring device over an RS485/USB converter, a maximum of 31 inverters can be connected in a daisy chain.

5. Commissioning of inverter

Outlines this Chapter

Introduce SOFAR 25~50KTLX-G3 safety inspection and start processing

5.1. Cable Connection Inspection



Attention

For first time operation, check the AC voltage and DC voltage are within the acceptable range

AC grid connection

Use multimeter to confirm that three lines and PE line are connect correctly. DC pv connection

Use multimeter to confirm that positive pole and negative pole of PV strings, and the Voc of each string is lower than the inverter max DC input.

5.2. Start Inverter

Step 1: Turn ON the DC switch.

Step 2: Turn ON the AC circuit breaker.

When the DC power generated by the solar array is enough, the SOFAR 25~50KTLX-G3 inverter will start automatically. Screen showing “normal” indicates correct operation.

NOTE 1: Choose the correct country code. (refer to section 6.3 of this manual)

NOTE 2: Different distribution network operators in different countries have different requirements regarding grid connections of PV grid connected inverters.

Therefore, it's very important to make sure that you have selected the correct country code according to requirements of local authority. Please consult qualified electrical engineer or personnel from electrical safety authorities about this.

Shenzhen SOFARSOLAR Co., Ltd. is not responsible for any consequences arising out of incorrect country code selection.

If the inverter indicates any fault, please refer to Section 7.1 of this manual ——— trouble shooting for help.

5.3. Shutdown inverter

Step 1: Turn OFF the AC circuit breaker.

Step 2: Turn OFF the DC switch.

5.4. Setting power quality response modes

The setting and viewing method of power quality response mode and power grid protection.

Once the power quality and grid settings have been selected at commissioning, these settings will be locked, end customers cannot modify by themselves. These setting require professional and technical personnel to conduct them by issuing and transmitting instructions on the remote monitoring platform, on the premise that the data acquisition rod is installed (WiFi/GPRS/Ethernet) . And the account must be authorized by SOFARSOLAR.

- Power quality settings can be set/view/changed by logging onto solarmanpv.com.
- Access to solarmanpv.com is restricted to authorised personnel only (refer to Section 5.5 for instructions on accessing solarmanpv.com).
- An account must be created to use solarmanpv.com.
- Technical personnel can send control instructions on the monitoring page to modify the mode and parameters of the machine, and the corresponding instructions need to be provided by internal professionals.

6. Operation interface

Outlines of this chapter

This section introduces the display, operation, buttons and LED indicator lights of SOFAR 25~50KTLX-G3 Inverter.

6.1. Operation and Display Panel

Buttons and Indicator lights

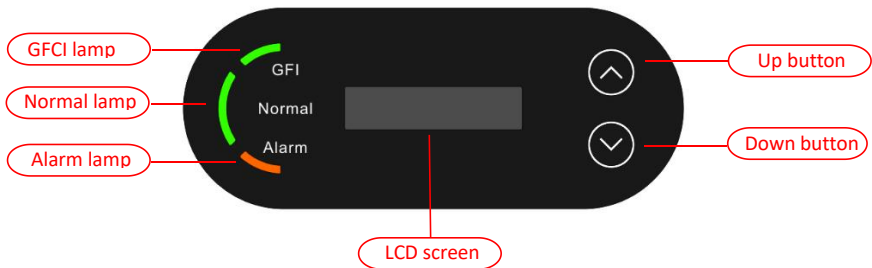

Button:

“^” Short press UP button = go up

“^” Long press UP button = exit menu or current interface

“v” Short press DOWN button = go down

“v” Long press DOWN button = enter menu or current interface

Indicator Lights:

“GFI” Red light ON = GFCI faulty

“Normal” Green light flashing = counting down or checking

“Normal” Green light ON = Normal

“Alarm” Red light ON= recoverable or unrecoverable faulty

6.2. Standard Interface

LCD interface indicated inverter status, alarm information, communication connection, PV input current and voltage, grid voltage, current and frequency, today generation, total generation.

Inverter working status, PV 1 input voltage and current

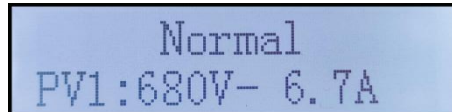

Normal
PV1:680V- 6.7A

Inverter working status, PV 2 input voltage and current

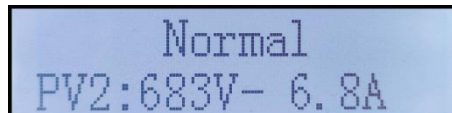

Normal
PV2:683V- 6.8A

Inverter working status, PV 3 input voltage and current

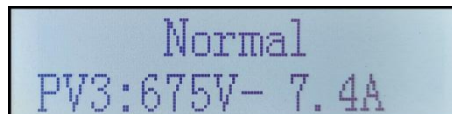

Normal
PV3:675V- 7.4A

Inverter working status, PV 4 input voltage and current

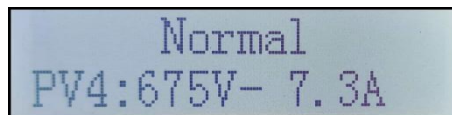

Normal
PV4:675V- 7.3A

Inverter working status, PV generated power

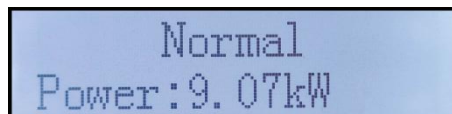

Normal
Power:9.07kW

Inverter working status, today generated electricity

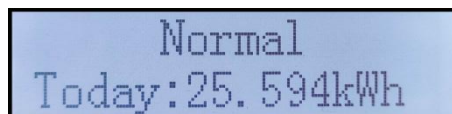

Normal
Today:25.594kWh

Inverter working status, total generated electricity



Normal
Total:25.4kWh

Inverter working status, grid voltage and current

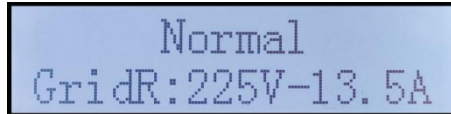

Normal
GridR:225V-13.5A

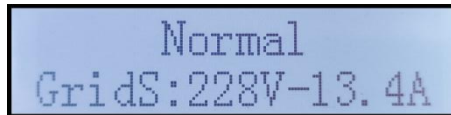

Normal
GridS:228V-13.4A

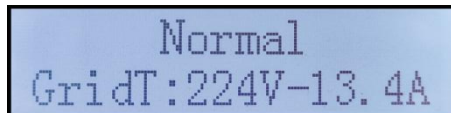

Normal
GridT:224V-13.4A

Inverter working status, grid voltage and frequency

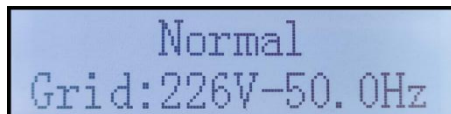

Normal
Grid:226V-50.0Hz

Inverter working status, USB status

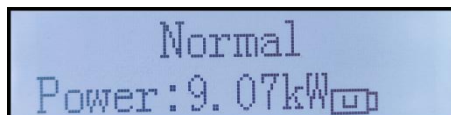

Normal
Power:9.07kW 

Inverter faulty alarm

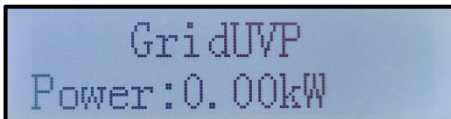

GridUVP
Power:0.00kW

When control board successfully connected with communication board, the LCD display the current state of the inverter, display as shown in the figure below.

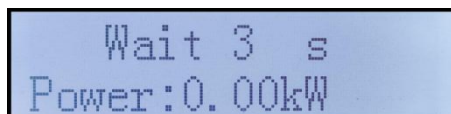

Wait 3 s
Power:0.00kW

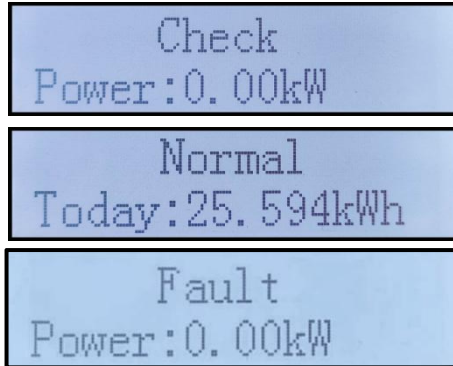

Inverter states includes: wait, check, normal and fault

Wait: Inverter is waiting to Check State when reconnect the system. In this state, grid voltage value is between the max and min limits and so on; If not, Inverter will go to Fault State or Permanent State.

Check: Inverter is checking isolation resistor, relays, and other safety requirements. It also does self-test to ensure inverter software and hardware are well functional. Inverter will go to Fault State or Permanent State if any error or fault occurs.

Normal: Inverter enter to Normal State, it is feeding power to the grid; inverter will go to Fault State or Permanent state if any error or fault occurs.

Fault: Fault State: Inverter has encountered recoverable error. It should recover if the errors disappear. If Fault State continues; please check the inverter according error code.

When the control board and communication board connection fail, the LCD display interface as shown in the figure below.

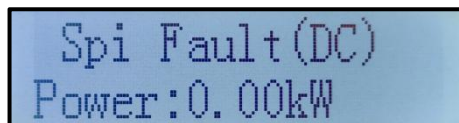

6.3. Main Interface

Long press the down button under standard interface to enter into main interface, Main interface including below information:

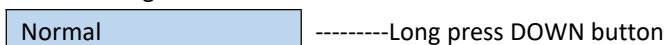

1.Enter Setting
2.Event List
3.SystemInfo
4.Display Time
5.Software Update

(A)Enter setting Interface as below :

1.Enter Setting	-----Long press DOWN button	
	1.Set time	9.Set Language
	2.Clear Energy	10.Set AntiReflux
	3.Clear Events	11.Logic Interface
	4.Set Country	12.IV Curve Scan
	5.On-Off Control	13.PCC Select
	6.Set Energy	14.Reflux Mode
	7.Set Address	15.Autotest Fast
	8.Set Input mode	16.Autotest STD

Long press the button to Enter the main interface of "1. Enter Setting" and long press to enter the setting menu. You can select the content you want to set by short pressing the button.

Note1: Some settings need to enter the password (the default password is 0001), when entering the password, short press to change the number, long press to confirm the current number, and long press after entering the correct password. If "password error, try again" appears, you will need to re-enter the correct password.

1. Set Time

Set the system time for the inverter.

2. Clear Energy

Clean the inverter of the total power generation.

3. Clear Events

Clean up the historical events recorded in the inverter.

4. Set Country

This menu is where you can select the country grid parameters, alternatively you can use the mobile APP. To import a country profile you will require the use of a USB drive. Once you insert a USB drive with a valid file you can then select and import it in the "Set SafetyPara" menu.

To use the Bluetooth APP to select the correct country code, the account must be linked and authorised as an installer. Once the country is set, it is read-only and can only be viewed and not modified by the end user.

Please contact and discuss with SOFARSOLAR technical support if you require a non standard parameter set.

Code		Country	Code		Country
000	000*	Germany VDE4105	024	000	Cyprus
	001	Germany BDEW	025	000	India
	002*	Germany VDE0126	026	000	Philippines
001	000	Italia CEI-021 Internal	028	000	New Zealand
	001*	Italia CEI-016 Italia		000	Brazil
	002*	Italia CEI-021 External		001	Brazil LV
	003	Italia CEI0-21 In Areti		002	Brazil 230
002	000	Australia A	029	003	Brazil 254
	008	Australia-B		000*	Slovakia VSD
	009	Australia-C		001*	Slovakia SSE
003	000	Spain RD1699		002*	Slovakia ZSD
004	000*	Turkey	033	000*	Ukraine
005	000	Denmark	034	000	Norway
	001	Denmark TR322		001	Norway-LV
006	000*	Greece Continent	035	000	Mexico LV
	001*	Greece island	038	000	Wide-Range-60Hz
007	000*	Netherland	039	000*	Ireland EN50438
008	000*	Belgium	040	000	Thailand PEA
	000	UK G59/G99		001	Thailand MEA
009	001	UK G83/G98	042	000	LV-Range-50Hz
	000	China	044	000	South Africa
010	001	China Taiwan	046	000*	Dubai DEWG
	000*	France		001	Dubai DEWG MV
011	001	France FAR Arrete23	107	000*	Croatia
	000	Poland	108	000*	Lithuania
012	000	Austria Tor Erzeuger			
013	000	Japan			
014	000	EU EN50438			
	001*	EU EN50549			

019	000	IEC EN61727			
020	000	Korea			
021	000	Sweden			
022	000	Europe General			

Table 7-1 Country code setting

For The Australian Market:

For compliance with AS/NZS 4777.2:2020 please select from

002-000 Australia A (Australia Region A)

002-008 Australia B (Australia Region B)

002-009 Australia C (Australia Region C)

Please contact your local grid operator for which option to select

Note: By selecting 002-000 Australia A, 002-008 Australia B or 002-009 Australia C the power quality response mode and grid protection settings will be reset to their default values for Australia Region A, B, C respectively.

Default grid settings for different regions are shown in the following table:

Protective function	Protective function limit	Trip delay time	Maximum disconnection time
Undervoltage 2($V \ll$)	70V	1s	2s
Undervoltage 1($V <$)	180V	10s	11s
Overvoltage 1($V >$)	265V	1s	2s
Overvoltage 2($V >$)	275V	-	0.2s

	Region	Australia A	Australia B	Australia C	New Zealand
Under-frequency 1 ($F <$)	Protective function limit value	47Hz	47Hz	45Hz	45Hz
	Trip delay time	1s	1s	5s	1s
	Maximum disconnection time	2s	2s	6s	2s
Over-frequency 1 ($F >$)	Protective function limit value	52Hz	52Hz	55Hz	55Hz
	Trip delay time	-	-	-	-
	Maximum disconnection time	0.2s	0.2s	0.2s	0.2s

Default volt-watt settings for different regions are shown in the following table:

Region	Default value	V_{L2}	V_{L1}	V_{W1}	V_{W2}
Australia A	Voltage	207	215	253	260
	Inverter output (P) % of S_{rated}	20%	100%	100%	20%
Australia B	Voltage	195	215	250	260
	Inverter output (P) % of S_{rated}	0%	100%	100%	20%
Australia C	Voltage	207	215	253	260
	Inverter output (P) % of S_{rated}	20%	100%	100%	20%

Default volt-var settings for different regions are shown in the following table:

Region	Default value	V_{V1}	V_{V2}	V_{V3}	V_{V4}
Australia A	Voltage	207	220	240	258
	Inverter reactive output (Q) % of S_{rated}	44% supplying	0%	0%	60% sinking
Australia B	Voltage	205	220	235	255
	Inverter reactive output (Q) % of S_{rated}	30% supplying	0%	0%	40% sinking
Australia C	Voltage	215	230	240	255
	Inverter reactive output (Q) % of S_{rated}	44% supplying	0%	0%	60% sinking

5. On-Off Control

Inverter on-off local control.

6. Set Energy

Set the total power generation. You can modify the total power generation through this option.

7. Set address

Set the address (when you need to monitor multiple inverters simultaneously), Default 01.

8. Set Input mode

SOFAR 25~50KTLX-G3 has 4 MPPT circuit, each MPPT circuit can work interdependently, or divided into parallel mode. User can change the setting according to the configuration.

9. Set Language

Set the inverter display language.

10. Set AntiReflux

Enable or disable Reflux. It is use for inverter generation and output limit control functions, but requires the use of external measuring equipment to obtain grid information.

"Enter"	1 Enter setting	"OK"	1 Set Time	
	2 Event List		2 Clean Energy	
"Up"↑	3 System Info	"Up"↑	3 Clean Events	
"Down"↑	4 Display Time	"Down"↑	
	5 Software Update		10 Set Reflux P	"OK" Input password!
"OK"	****	Input 0001	0001	"OK" Anti Reflux Control
				Hard Anti Reflux Control

Anti Reflux Control	"OK"	Enable	"OK"	*.**KW	Input the allowable export power
		Disable			
Hard Anti Reflux Control	"OK"	Enable	"OK"	*.**KW	Input the allowable export power
		Disable			

Press "Up" or "Down" to change the value of the first digit. Press "OK" to switch to second digit. Press "Up" or "Down" to change the value of the second digit. After inputting all digit press "OK" to confirm.

Note: When enabling the Hard Anti Reflux Control and Anti Reflux Control at the same time, generation limit control will be enabled. note that the allowable export power of soft limit should be smaller than that of the hard limit. After the setting is successful, the off-grid time after the communication failure of the meter is changed from 5S to 15-20S.

11. Logic interface

Enable or disable logical interfaces. It is use for below standard Australia (AS4777), Europe General (50549), German (4105).

12. IV Curve Scan

Shadow scanning, when the component is blocked or abnormal, causing multiple power peaks, by enabling this function, the peak point of maximum power can be tracked.

13. PCC Select

The function is divided into two options: PCC Meter and PCC ARPC, the first one is the default usage for SOFAR 25-50KTLX-G3. Refer to <7.5 Smart meter instruction in this manual for specific operation methods.

14. Reflux Mode

The function is divided into three options: CTR Totalpower, CTR Phasepower and CTR SellingPower, the first one is the default usage for SOFAR 25-50KTLX-G3. Refer to <7.5 Smart meter usage in this manual for specific operation methods.

15. Autotest Fast

15.Autotest Fast	OK	Start Autotest	Long press the “v” to start
		Testing 59.S1...	
		↓	Wait
		Test 59.S1 OK!	
		↓	Wait
		Testing 59.S2...	
		↓	Wait
		Test 59.S2 OK!	
		↓	Wait
		Testing 27.S1...	
		↓	Wait
		Test 27.S1 OK!	
		↓	Wait
		Testing 27.S2...	
		↓	Wait
		Test 27.S2 OK!	
↓	Wait		
Testing 81>S1...			
↓	Wait		
Test 81>S1 OK!			
↓	Wait		
Testing 81>S2...			
↓	Wait		
Test 81>S2 OK!			

↓	Wait
Testing 81<S1...	
↓	Wait
Test 81<S1 OK!	
↓	Wait
Testing 81<S2...	
↓	Wait
Test 81<S2 OK!	
↓	Long press the “ v ”
Auto Test OK!	
↓	Short press the “ v ”
59.S1 threshold 253V 900ms	
↓	Short press the “ v ”
59.S1: 228V 902ms	
↓	Short press the “ v ”
59.S2 threshold 264.5V 200ms	
↓	Short press the “ v ”
59.S2: 229V 204ms	
↓	Short press the “ v ”
27.S1 threshold 195.5V 1500ms	
↓	Short press the “ v ”
27.S1: 228V 1508ms	
↓	Short press the “ v ”
27.S2 threshold 34.5V 200ms	
↓	Short press the “ v ”
27.S2: 227V 205ms	
↓	Short press the “ v ”
81>.S1 threshold 50.5Hz 100ms	
↓	Short press the “ v ”
81>.S1 49.9Hz 103ms	
↓	Short press the “ v ”
81>.S2 threshold 51.5Hz 100ms	
↓	Short press the “ v ”
81>.S2 49.9Hz 107ms	

↓	Short press the “ v ”
81<.S1 threshold 49.5Hz 100ms	
↓	Short press the “ v ”
81<.S1 50.0Hz 105ms	
↓	Short press the “ v ”
81<.S2 threshold 47.5Hz 100ms	
↓	Short press the “ v ”
81<.S2 50.1Hz 107ms	

16. Autotest STD

16.Autotest STD Long press the “ v ”

The test procedure is same as Autotest Fast, but it’s much more time consuming.

(B) Event List:

Event List is used to display the real-time event records, including the total number of events and each specific ID No. and happening time. User can enter Event List interface through main interface to check details of real-time event records, Event will be listed by the happening time, and recent events will be listed in the front. Please refer to below picture. Long press the button and short press the button to turn the page in standard interface, then enter into “2. Event List” interface.

2. Event List	
1. Current event	2. History event
Fault information	001 ID04 06150825 (Display the event sequence number, event ID number, and event occurrence time)

(A) “SystemInfo” Interface as below

3.SystemInfo	-----Long press DOWN button
1.Inverter Type	
2.Serial Number	
3.Soft Version	
4.Hard Version	
5.Country	

6.Modbus Address
7.Input Mode

The user enters the main menu by long pressing the DOWN button, short press and turns the page to select menu contents, then long press the button to enter "3. SystemInfo". Turning the page down can select the system information to view.

(B) Display Time

Long press the button and short press the button to turn the page in the standard user interface to enter into "4. Display Time", then long press the button to display the current system time.

(C) Software Update

User can update software by USB flash disk, SOFARSOLAR will provide the new update software called firmware for user if it is necessary, the user needs to copy the upgrade file to the USB flash disk.

6.4. Updating Inverter Software

SOFAR 25~50KTLX-G3 inverter offer software upgrade via USB flash drive to maximize inverter performance and avoid inverter operation error caused by software bugs.

Step 1: turn off AC circuit breaker and DC switch, remove the communication board cover as below figure. If the RS485 line has been connected, please release the waterproof nut first and make sure the communication line is no longer the force. Then remove the waterproof cover.

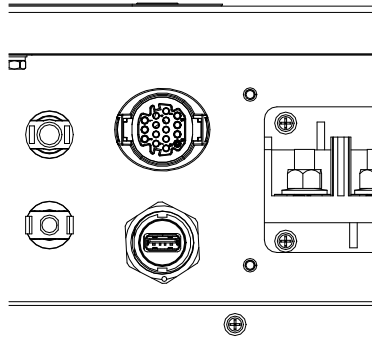

Figure 6-1 Remove communication broad cover

Step 2: Insert USB into computer;

Step 3: SOFARSOLAR service team will send the software code to user, after user receive the file, please decompressing file and cover the original file in USB flash drive.

Step 4: Insert USB flash disk into the USB port of inverter.

Step 5: Then turn on DC switch, screen show “recoverable fault” (as AC circuit breaker still open, inverter cannot detect grid power, so it may show “recoverable fault”)

Step 6: Long press “DOWN” button to enter the menu, then short press “DOWN” button to find "5. SoftwareUpdate" in the LCD display, long press “DOWN” button to enter input password interface.

Step 7: Input the password, if password is correct, and then begin the update process.

Step 8: System update main DSP, slave DSP and ARM in turns. If main DSP update success, the LCD will display “Update DSP1 Success”, otherwise display "Update DSP1 Fail"; If slave DSP update success, the LCD will display "Update DSP2 Success", otherwise display "UpdatedSP2 Fail".

Step 9: After the update is completed, turn off the DC breaker, wait for the LCD screen extinguish, then recover the communication waterproof and then turn on the DC breaker and AC breaker again, the inverter will enter the running state. User

can check the current software version in SystemInfo>>3.SoftVersion.

Note: If screen shows “Communication fail”, “Update DSP1 fail”, “Update DSP2 fail” please turn off the DC switch, wait for the LCD screen turn off, then turn on the DC switch again, then Continue to update from step 5.

6.5. Smart meter instruction

Generation and Export Limit Control functions for the inverter are available but require the use of an external measurement device to obtain grid information.

Step 1: In the standard interface, Long press DOWN button to enter the "1. Enter Setting" interface, and then Short press DOWN button to enter "13.PCC Select" interface, long press DOWN button to confirm the input password (initial password is 0001), press up or down to find "PCC Meter", and then long press DOWN button to display "14.Reflux Mode". In the "Anti-Reflux Mode" (14.Reflux Mode) interface, select one of the CTR Totalpower, CTR Phasepower, or CTR SellingPower by press DOWN button, ."success" will be displayed if setting successfully.

Step 2: In the standard interface, Long press DOWN button to enter the "1. Enter Setting" interface, and then Short press DOWN button to enter the "10. Set AntiReflux" interface, long press DOWN button to confirm the input password (initial password is 0001), the power setting can be entered by pressing the UP or DOWM button to find the "Reflux Enable", and Long press the DOWM button for confirmation; Press the up or DOWM button to change the size of the value, and then long press the DOWM button to complete the input of the current value, and enter the setting of the next value. After setting the fourth number, long press the DOWM button to confirm, the value selection of antiReflux power can be completed.

Note: Explanation of professional terms:

CTR Totalpower: The Sum of three-phase selling power of the connection point <= The set Reflux power

CTR Phasepower: The sum of the three phase power vector of the connection point
= The set Reflux power

CTR SellingPower: The selling power of any phase of the system connection point
<= The set Reflux power /3

Selling electricity: sending electricity to the grid

Buy electricity: take energy from the grid

Anti-Reflux: limit the energy sent to the grid

Positive power: the power purchased

Negative power: the power of selling electricity

7. Trouble shooting and maintenance

7.1. Troubleshooting

This section describes the potential errors for this product. Please read carefully for the following tips when doing the troubleshooting:

- 1) Check the warning message or faulty codes on the inverter information panel
- 2) If not any error code display on the panel, please check the following lists:
 - Is inverter be installed in a clean, dry, ventilated environment?
 - Is the DC switch turn off?
 - Are the cable cross section area and length meet the requirement?
 - Are the input and output connection and wiring in good condition?
 - Are the configuration settings correctly for the particular installation?

This section contains the potential errors, resolution steps, and provide users with troubleshooting methods and tips

The process to check the event list can refers to Manual Chapter 7.3 (B)

List7-1 Even list

Code	Name	Description	Solution
ID001	GridOVP	The grid voltage is too high	If the alarm occurs occasionally, the possible cause is that the electric grid is abnormal occasionally. Inverter will automatically return to normal operating status when the electric grid's back to normal.
ID002	GridUVP	The grid voltage is too low	
ID003	GridOFP	The grid frequency is too high	
ID004	GridUFP	The grid frequency is too low	If the alarm occurs frequently, check whether the grid voltage/frequency is within the acceptable range. If yes, please check the AC circuit breaker and AC wiring of the inverter. If the grid voltage/frequency is NOT within the acceptable range and AC wiring is correct, but the alarm occurs repeatedly,

			contact technical support to change the grid over-voltage, under-voltage, over-frequency, under-frequency protection points after obtaining approval from the local electrical grid operator.
ID005	GFCI	Charge Leakage Fault	Check for inverter and wiring.
ID006	OVRT fault	OVRT function is faulty	<p>If the alarm occurs occasionally, the possible cause is that the electric grid is abnormal occasionally. Inverter will automatically return to normal operating status when the electric grid's back to normal.</p> <p>If the alarm occurs frequently, check whether the grid voltage/frequency is within the acceptable range. If yes, please check the AC circuit breaker and AC wiring of the inverter.</p> <p>If the grid voltage/frequency is NOT within the acceptable range and AC wiring is correct, but the alarm occurs repeatedly, contact technical support to change the grid over-voltage, under-voltage, over-frequency, under-frequency protection points after obtaining approval from the local electrical grid operator.</p>
ID007	LVRT fault	LVRT function is faulty	
ID008	IslandFault	Island protection error	
ID009	GridOVPIinstant1	Transient overvoltage of grid voltage 1	
ID010	GridOVPIinstant2	Transient overvoltage of grid voltage 2	
ID011	VGridLineFault	Power grid line voltage error	
ID013	RefluxFault	Anti-Reflux function is faulty	
ID017	HwADFaultIGrid	Power grid current sampling error	
ID018	HwADFaultDCI	Wrong sampling of dc component of grid current	
ID019	HwADFaultVGrid(DC)	Power grid voltage sampling error (DC)	
ID020	HwADFaultVGrid(AC)	Power grid voltage sampling error (AC)	
ID021	GFCIDeviceFault(DC)	Leakage current sampling error(DC)	
ID022	GFCIDeviceFault(AC)	Leakage current sampling error(AC)	
ID024	HwADFaultIdc	Dc input current sampling error	
ID029	ConsistentFault_GFCI	Leakage current consistency error	
ID030	ConsistentFault_Vgrid	Grid voltage consistency error	
ID031	ConsistentDCI	DCI consistency error	
ID033	SpiCommFault(DC)	SPI communication error (DC)	
ID034	SpiCommFault(AC)	SPI communication error (AC)	
ID035	SChip_Fault	Chip error (DC)	
ID036	MChip_Fault	Chip error (AC)	
ID038	InvSoftStartFail	Inverter failed to	

		output	
ID041	RelayFail	Relay detection failure	
ID042	IsoFault	Low insulation impedance	Check the insulation resistance between the photovoltaic array and ground (ground), if there is a short circuit, the fault should be repaired in time.
ID043	PEConnectFault	Ground fault	Check ac output PE wire for grounding.
ID044	ConfigError	Error setting input mode	Check the input mode (parallel/independent mode) Settings for the inverter. If not, change the input mode.
ID048	SNTYPEFault	Serial number fault	Internal faults of inverter, switch OFF inverter, wait for 5 minutes, then switch ON inverter. Check whether the problem is solved. If no, please contact technical support.
ID050	TempFault_HeatSink1	Radiator 1 temperature protection	
ID057	TempFault_Env1	Ambient temperature 1 protection	
ID059	TempFault_Inv1	Module 1 temperature protection	
ID065	VbusRmsUnbalance	Unbalanced bus voltage RMS	
ID066	VbusInstantUnbalance	The transient value of bus voltage is unbalanced	
ID072	SwBusRmsOVP	Inverter bus voltage RMS software overvoltage	
ID073	SwBusInstantOVP	Inverter bus voltage instantaneous value software overvoltage	
ID082	DciOCP	Dci overcurrent protection	Internal faults of inverter, switch OFF inverter, wait for 5 minutes, then switch ON inverter. Check whether the problem is solved.
ID083	SwOCPInstant	Output instantaneous current protection	If no, please contact technical support.
ID085	SwAcRmsOCP	Output effective value current protection	
ID086	SwPVOCPInstant	PV overcurrent software protection	
ID098	HwBusOVP	Inverter bus hardware overvoltage	
ID102	HwPVOCP	PV hardware overflows	
ID103	HwACOCP	Ac output hardware overflows	

ID105	MeterCommFault	Meters communication fault	Check whether the meters wiring is correct.
ID113	OverTempDerating	Internal temperature is too high.	Make sure the inverter is installed where there is no direct sunlight. Please ensure that the inverter is installed in a cool/well ventilated place. Ensure the inverter is installed vertically and the ambient temperature is below the inverter temperature limit.
ID114	FreqDerating	AC frequency is too high	Please make sure the grid frequency and voltage is within the acceptable range.
ID129	unrecoverHwAcOCP	Output hardware overcurrent permanent failure	Internal faults of inverter, switch OFF inverter, wait for 5 minutes, then switch ON inverter. Check whether the problem is solved. If no, please contact technical support.
ID134	unrecoverAcOCPI nstant	Output transient overcurrent permanent failure	
ID135	unrecovertlacUnbalance	Permanent failure of unbalanced output current	
ID141	unrecoverVbusUnbalance	Bus voltage unbalanced permanent failure	
ID142	PermSpdFail(DC)	PV surge protection	
ID143	PermSpdFail(AC)	Grid surge protection	
ID145	USBFault	USB fault	
ID146	WifiFault	Wifi fault	Check the Wifi port of the inverter
ID147	BluetoothFault	Bluetooth fault	Check the bluetooth connection of the inverter
ID152	SafetyVerFault	The software version is inconsistent with the safety version	/
ID154	SciCommLose(AC)	SCI communication error (AC)	
ID156	SoftVerError	Inconsistent software versions	Contact for technical support and software upgrades.
ID169	FanFault1	Fan 1 fault	Please check whether the fan 1 of inverter is running normally.
ID170	FanFault2	Fan 2 fault	Please check whether the fan 2 of inverter is running normally.
ID171	FanFault3	Fan 3 fault	Please check whether the fan 3 of inverter is running normally.
ID172	FanFault4	Fan 4 fault	Please check whether the fan 4 of inverter is running normally.
ID173	FanFault5	Fan 5 fault	Please check whether the fan 5 of inverter is running normally.

ID174	FanFault6	Fan 6 fault	Please check whether the fan 6 of inverter is running normally.
ID175	FanFault7	Fan 7 fault	Please check whether the fan 7 of inverter is running normally.
ID193	StrFuseALM1-1	StrFuseALM1-1	Group fuse alarm, only for Korean safety regulations.
ID194	StrFuseALM1-2	StrFuseALM1-2	
ID195	StrFuseALM2-1	StrFuseALM2-1	
ID196	StrFuseALM2-2	StrFuseALM2-2	
ID197	StrFuseALM3-1	StrFuseALM3-1	
ID198	StrFuseALM3-2	StrFuseALM3-2	
ID199	StrFuseALM4-1	StrFuseALM4-1	
ID200	StrFuseALM4-2	StrFuseALM4-2	
ID201	StrFuseALM5-1	StrFuseALM5-1	
ID202	StrFuseALM5-2	StrFuseALM5-2	
ID203	StrFuseALM6-1	StrFuseALM6-1	
ID204	StrFuseALM6-2	StrFuseALM6-2	
ID205	StrFuseALM7-1	StrFuseALM7-1	
ID206	StrFuseALM7-2	StrFuseALM7-2	
ID207	StrFuseALM8-1	StrFuseALM8-1	
ID208	StrFuseALM8-2	StrFuseALM8-2	
ID209	StrFuseALM9-1	StrFuseALM9-1	
ID210	StrFuseALM9-2	StrFuseALM9-2	
ID211	StrFuseALM10-1	StrFuseALM10-1	
ID212	StrFuseALM10-2	StrFuseALM10-2	
ID213	StrFuseALM11-1	StrFuseALM11-1	
ID214	StrFuseALM11-2	StrFuseALM11-2	
ID215	StrFuseALM12-1	StrFuseALM12-1	
ID216	StrFuseALM12-2	StrFuseALM12-2	

Note: the above table is our general fault ID list, all fault IDs of this inverter can be found in the above table.

This inverter complies with IEC 62109-2 clause 13.9 for earth fault alarm monitoring.

If an Earth Fault Alarm occurs, the inverter will initiate the fault will be displayed on the LCD screen (PVIsoFault), the red alarm light will be on, and a buzzing noise will come from the inverter. The fault can be found in the event list (fault code history). For the machine installed with WiFi/GPRS, the alarm information can be seen on the corresponding monitoring website, and can also be received by the APP on the mobile phone.

7.2. Maintenance

Inverters generally do not need any daily or routine maintenance. But ensure heat sink should not be blocked by dust, dirt or any other items. Before the cleaning, make sure that the DC SWITCH is turned OFF and the circuit breaker between inverter and electrical grid is turned OFF. Wait at least for 5 minutes before the Cleaning.

✧ Inverter cleaning

Please clean the inverter with an air blower, a dry & soft cloth or a soft bristle brush. Do NOT clean the inverter with water, corrosive chemicals, detergent, etc.

✧ Heat sink cleaning

For the long-term proper operation of inverters, ensure there is enough space around the heat sink for ventilation, check the heat sink for blockage (dust, snow, etc.) and clean them if they exist. Please clean the heat sink with an air blower, a dry & soft cloth or a soft bristle brush. Do NOT clean the heat sink with water, corrosive chemicals, detergent, etc.

✧ Fan cleaning

For inverter SOFAR 25~50KTLX-G3 with fans, please check if inverter have abnormal sound when inverter is operating. Check if fan on cracks, replace a new fan when necessary. Refers to below section.

7.3. Fan Maintenance

For SOFAR 25~50KTLX-G3 series inverter with fans, if fan is broken or not working properly may cause inverter heat dissipation issue and effect the working efficiency of inverter. Thus, fans need to have regularly cleaning and maintain, details operating as below:

Step 1: Closed inverter, check the wiring side to ensure all electrical connection of inverter is turn off ;

Step 2: Unscrew six screws at the corner of fans baseboard ;

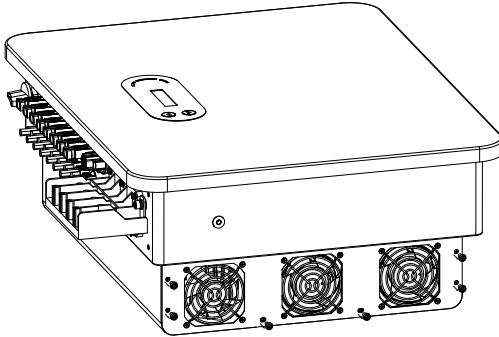

Figure 7-1 remove the six screws from the fan base plate

Step 3: Remove the screws at the fan position , unplug the terminal at the fan and inverter interface and completely remove the fan;

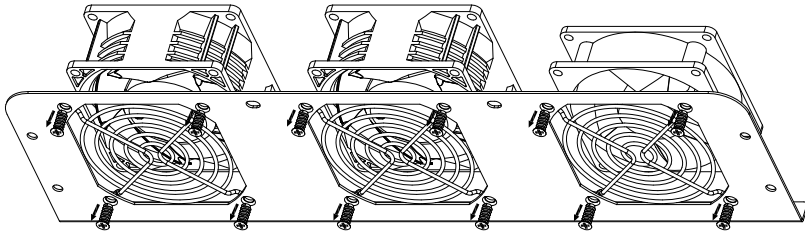

Figure 7-2 remove the fan and protective cover

Step 4: Use a soft brush to clean the fan. If it is damaged, please replace it in time;

Step 5: Re-install the inverter according to the above steps.

8. Technical Data

Outlines of this Chapter

This chapter outline the SOFAR 25~50KTLX-G3 model type and technical parameters

Model	SOFAR 25KTLX-G3	SOFAR 30KTLX-G3	SOFAR 30KTLX-G3-A	SOFAR 33KTLX-G3	SOFAR 36KTLX-G3
Datasheet					
Input (DC)					
Recommended Max. PV input power	37500Wp	45000Wp	45000Wp	49500Wp	54000Wp
Number of MPP trackers	3	3	3	3	3
Number for DC inputs	6	6	6	6	6
Max. input voltage	1100V				
Start-up voltage	200V				
Rated input voltage	620V	620V	620V	620V	620V
MPPT operating voltage range	180V-1000V				
Full power MPPT voltage range	480~850V	480~850V	480~850V	510~850V	540~850V
Max. input MPPT current	3*40A	3*40A	3*40A	3*40A	3*40A
Max. input short circuit current per MPPT	3*50A	3*50A	3*50A	3*50A	3*50A
Output (AC)					
Rated power	25000W	30000W	29900W	33000W	36000W
Max. AC power	28000VA	34000VA	29900VA	37000VA	40000VA
Rated output current	36.2A/37.9A	43.5A/45.5A	43.3A/45.3A	47.8A/50.0A	52.2A/54.5A

Max. output current	42.4A	51.5A	45.3A	56A	60.6A
Nominal grid voltage	3/N/PE, 220/380Vac, 230/400Vac				
Grid voltage range	310Vac-480Vac (According to local standard)				
Nominal frequency	50 / 60Hz				
Grid frequency range	45Hz-55Hz/54Hz-66Hz (According to local standard)				
Active power adjustable range	0~100%				
THDi	<3%				
Power factor	1 default (adjustable +/-0.8)				
Efficiency					
Max efficiency	98.6%	98.6%	98.6%	98.6%	98.6%
European weighted efficiency	98.2%	98.2%	98.2%	98.2%	98.2%
Protection					
DC reverse polarity protection	Yes				
Anti-islanding protection	Yes				
Leakage current protection	Yes				
Ground fault monitoring	Yes				
PV-array string fault monitoring	Yes				
Anti reverse power function	Yes				
DC switch	Yes				
AFCl protection	Optional				
Anti-PID function	Optional				
Input/ output SPD	PV: type II standard, AC: type II standard				
Communication					
Communication	RS485/USB/Bluetooth, Optional:WiFi /GPRS /4G /PLC				

General Data	
Ambient temperature range	-30°C~+60°C
Self-consumption at night	<3W
Topology	Transformer-less
Degree of protection	IP65
Allowable relative humidity range	0~100%
Max. operating altitude	4000m
Noise	<60dB
Weight	36kg
Cooling	Fan
Dimension	585×480×220mm
Display	LCD & Bluetooth +APP
Warranty	5 years, Optional: 7 years/ 10 years
Standard	
EMC	EN 61000-6-2, EN 61000-6-3, EN 61000-3-11, EN 61000-3-12
Safety standard	IEC 62109-1/2, IEC 62116, IEC 61727, IEC 61683, IEC 60068(1,2,14,30),IEC 60255
Grid standard	AS/NZS 4777, VDE V 0124-100, V 0126-1-1, VDE-AR-N 4105, CEI 0-21/CEI 0-16, UNE 206 007-1, EN50549, G98/G99, EN50530, NB/T32004

Model Datasheet	SOFAR 40KTLX-G3	SOFAR 45KTLX-G3	SOFAR 50KTLX-G3	SOFAR 40KTLX-G3-HV	SOFAR 50KTLX-G3-HV
Input (DC)					
Recommended Max. PV input power	60000Wp	67500Wp	75000Wp	60000Wp	75000Wp
Number of MPP trackers	4	4	4	3	4
Number for DC inputs	8	8	8	6	8
Max. input voltage	1100V				
Start-up voltage	200V				
Rated input voltage	620V	620V	620V	725V	725V
MPPT operating voltage range	180V-1000V				
Full power MPPT voltage range	480~850V	510~850V	540~850V	620~850V	650~850V
Max. input MPPT current	4*40A	4*40A	4*40A	3*40A	4*40A
Max. input short circuit current per MPPT	4*50A	4*50A	4*50A	3*50A	4*50A
Output (AC)					
Rated power	40000W	45000W	50000W	40000W	50000W
Max. AC power	44000VA	50000VA	55000VA	44000VA	55000VA
Rated output current	58.0A/ 60.6A	65.2A/ 68.2A	72.5A/ 75.8A	48.1A	60.2A
Max. output current	66.7A	75.8A	83.3A	53A	66.2A
Nominal grid voltage	3/N/PE, 220/380Vac, 230/400Vac, 240/415Vac			3/N/PE or 3/PE, 277/480Vac	
Grid voltage range	310Vac-480Vac (According to local standard)			422Vac-528Vac (According to local standard)	
Nominal frequency	50 / 60Hz				
Grid frequency range	45Hz-55Hz/54Hz-66Hz (According to local standard)				

Active power adjustable range	0~100%				
THDi	<3%				
Power factor	1 default (adjustable +/-0.8)				
Efficiency					
Max efficiency	98.8%	98.8%	98.8%	98.9%	98.9%
European weighted efficiency	98.2%	98.2%	98.2%	98.2%	98.2%
Protection					
DC reverse polarity protection	Yes				
Anti-islanding protection	Yes				
Leakage current protection	Yes				
Ground fault monitoring	Yes				
PV-array string fault monitoring	Yes				
Anti reverse power function	Yes				
DC switch	Yes				
AFCL protection	Optional				
Anti-PID function	Optional				
Input/ output SPD	PV: type II standard, AC: type II standard				
Communication					
Communication	RS485/USB/Bluetooth, Optional:WiFi /GPRS /4G /PLC				
General Data					
Ambient temperature range	-30°C~+60°C				
Self-consumption at night	<3W				
Topology	Transformer-less				
Degree of protection	IP65				

Allowable relative humidity range	0~100%
Max. operating altitude	4000m
Noise	<60dB
Weight	37kg
Cooling	Fan
Dimension	585×480×220mm
Display	LCD & Bluetooth +APP
Warranty	5 years, Optional: 7 years/ 10 years
Standard	
EMC	EN 61000-6-2, EN 61000-6-3, EN 61000-3-11, EN 61000-3-12
Safety standard	IEC 62109-1/2, IEC 62116, IEC 61727, IEC 61683, IEC 60068(1,2,14,30),IEC 60255
Grid standard	AS/NZS 4777, VDE V 0124-100, V 0126-1-1, VDE-AR-N 4105, CEI 0-21/CEI 0-16, UNE 206 007-1, EN50549, G98/G99, EN50530, NB/T32004

Note: the product may be upgraded in the future. The above parameters are for reference only. Please refer to the real product.

9. Quality Assurance

Standard warranty period

The standard warranty period of inverter is 120 months (10 years). There are two calculation methods for the warranty period:

1. Purchase invoice provided by the customer: the first flight provides a standard warranty period of 120 months (10 years) from the invoice date;
2. The customer fails to provide the invoice: from the production date (according to the SN number of the machine), Our company provides a warranty period of 123 months (10.25 years).
3. In case of any special warranty agreement, the purchase agreement shall prevail.

Extended warranty period

Within 12 months of the purchase of the inverter (based on the purchase invoice) or within 24 months of the production of the inverter (SN number of machines, based on the first date of arrival), Customers can apply to buy extended warranty products from the company's sales team by providing the product serial number, our company may refuse to do not conform to the time limit extended warranty purchase application. Customers can buy an extended warranty of 5, 10, 15 years.

If the customer wants to apply for the extended warranty service, please contact the sales team of our company. to purchase the products that are beyond the purchase period of extended warranty but have not yet passed the standard quality warranty period. Customers shall bear different extended premium.

During the extended warranty period, PV components, USB acquisition stick (WIFI/Ethernet) and lightning protection devices are not included in the extended warranty period. If they fail during the extended warranty period, customers need to purchase and replace them from our company.

Once the extended warranty service is purchased, our company will issue the

extended warranty card to the customer to confirm the extended warranty period.

Invalid warranty clause

Equipment failure caused by the following reasons is not covered by the warranty:

- 1) The "warranty card" has not been sent to the distributor or our company;
- 2) Without the consent of our company to change equipment or replace parts;
- 3) Use unqualified materials to support our company 's products, resulting in product failure;
- 4) Technicians of non-company modify or attempt to repair and erase the product serial number or silk screen;
- 5) Incorrect installation, debugging and use methods;
- 6) Failure to comply with safety regulations (certification standards, etc.);
- 7) Damage caused by improper storage by dealers or end users;
- 8) Transportation damage (including scratches caused by internal packaging during transportation). Please claim directly from the transportation company or insurance company as soon as possible and obtain damage identification such as container/package unloading;
- 9) Failure to follow the product user manual, installation manual and maintenance guidelines;
- 10) Improper use or misuse of the device;
- 11) Poor ventilation of the device;
- 12) The product maintenance process does not follow relevant standards;
- 13) Failure or damage caused by natural disasters or other force (such as earthquake, lightning strike, fire, etc.)



Product Name: PV Grid-Connected Inverter
Company Name: Shenzhen SOFARSOLAR Co., Ltd.
ADD: 11/F., Gaoxinqi Technology Building, No.67 Area, Xingdong Community,
Xin'an Sub-district, Bao'an District, Shenzhen City, China
Email: service@sofarsolar.com
Tel: 0510-6690 2300
Web: www.sofarsolar.com