

 **WKS** EVO Circle

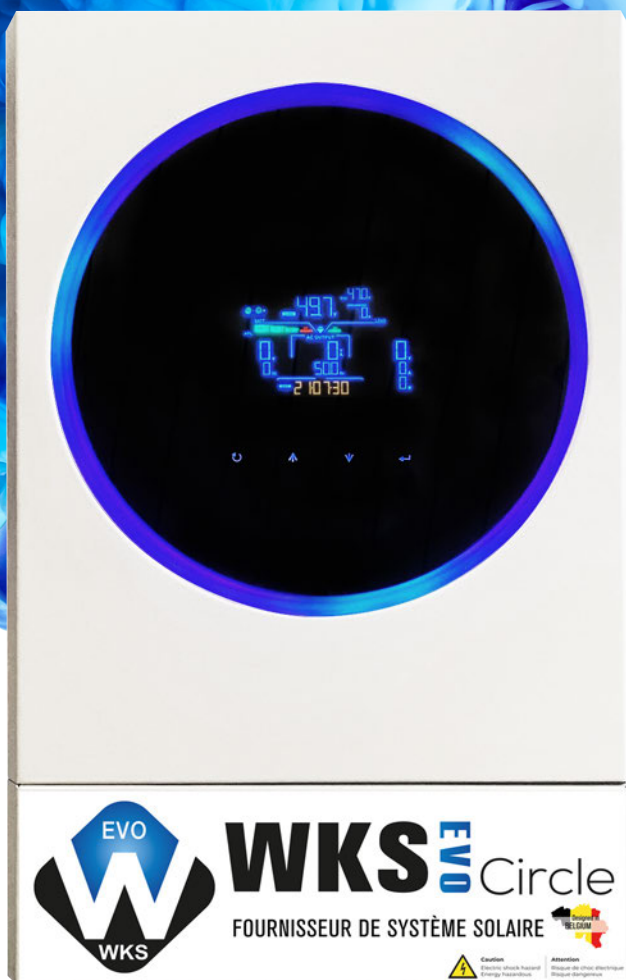

5,6KW INVERTER / SOLAR CHARGER

Table of Contents

ABOUT THIS MANUAL	1
Purpose.....	1
Scope.....	1
SAFETY INSTRUCTIONS.....	1
INTRODUCTION	2
Features.....	2
Basic System Architecture	2
Product Overview.....	3
Unpacking and Inspection	4
Preparation	4
Mounting the Unit.....	4
Battery Connection	5
AC Input/Output Connection.....	6
PV Connection	7
Final Assembly.....	9
Communication Connection.....	9
Dry Contact Signal	10
OPERATION.....	11
Power ON/OFF	11
Operation and Display Panel	11
LCD Display Icons	12
LCD Setting.....	15
LCD Display	31
Operating Mode Description	37
Faults Reference Code.....	40
Warning Indicator	41
BATTERY EQUALIZATION	42
SPECIFICATIONS.....	43
Table 1 Line Mode Specifications	43
Table 2 Inverter Mode Specifications	44
Table 3 Charge Mode Specifications.....	45
Table 4 General Specifications.....	45
TROUBLE SHOOTING	46
Appendix I: Parallel function	47
Appendix II: BMS Communication Installation.....	64
Appendix III: The Wi-Fi Operation Guide.....	72

ABOUT THIS MANUAL

Purpose

This manual describes the assembly, installation, operation and troubleshooting of this unit. Please read this manual carefully before installations and operations. Keep this manual for future reference.

Scope

This manual provides safety and installation guidelines as well as information on tools and wiring.

SAFETY INSTRUCTIONS

⚠ WARNING: This chapter contains important safety and operating instructions. Read and keep this manual for future reference.

1. Before using the unit, read all instructions and cautionary markings on the unit, the batteries and all appropriate sections of this manual.
2. CAUTION – To reduce risk of injury, charge only deep-cycle lead acid type rechargeable batteries. Other types of batteries may burst, causing personal injury and damage.
3. Do not disassemble the unit. Take it to a qualified service center when service or repair is required. Incorrect re-assembly may result in a risk of electric shock or fire.
4. To reduce risk of electric shock, disconnect all wirings before attempting any maintenance or cleaning. Turning off the unit will not reduce this risk.
5. CAUTION – Only qualified personnel can install this device with battery.
6. NEVER charge a frozen battery.
7. For optimum operation of this inverter/charger, please follow required spec to select appropriate cable size. It's very important to correctly operate this inverter/charger.
8. Be very cautious when working with metal tools on or around batteries. A potential risk exists to drop a tool to spark or short circuit batteries or other electrical parts and could cause an explosion.
9. Please strictly follow installation procedure when you want to disconnect AC or DC terminals. Please refer to INSTALLATION section of this manual for the details.
10. Fuses are provided as over-current protection for the battery supply.
11. GROUNDING INSTRUCTIONS -This inverter/charger should be connected to a permanent grounded wiring system. Be sure to comply with local requirements and regulation to install this inverter.
12. NEVER cause AC output and DC input short circuited. Do NOT connect to the mains when DC input short circuits.
13. Warning!! Only qualified service persons are able to service this device. If errors still persist after following troubleshooting table, please send this inverter/charger back to local dealer or service center for maintenance.
14. WARNING: Because this inverter is non-isolated, only three types of PV modules are acceptable: single crystalline, poly crystalline with class A-rated and CIGS modules. To avoid any malfunction, do not connect any PV modules with possible current leakage to the inverter. For example, grounded PV modules will cause current leakage to the inverter. When using CIGS modules, please be sure NO grounding.
15. CAUTION: It's required to use PV junction box with surge protection. Otherwise, it will cause damage on inverter when lightning occurs on PV modules.

INTRODUCTION

This is a multi-function inverter, combining functions of inverter, solar charger and battery charger to offer uninterruptible power support in a single package. The comprehensive LCD display offers user-configurable and easy-accessible button operations such as battery charging current, AC or solar charging priority, and acceptable input voltage based on different applications.

Features

- Pure sine wave inverter
- Customizable status LED ring with RGB lights
- Touchable button with 4.3" colored LCD
- Built-in Wi-Fi for mobile monitoring (APP is available)
- Supports USB On-the-Go function
- Data log events stored in the inverter
- Built-in anti-dusk kit
- Reserved communication port for BMS
- Battery independent function
- Parallel operation up to 9 units

Basic System Architecture

The following illustration shows basic application for this unit. It also required the following devices to have a complete running system:

- Generator or Utility mains.
- PV modules

Consult with your system integrator for other possible system architectures depending on your requirements.

This inverter can power various appliances in home or office environment, including motor-type appliances such as tube light, fan, refrigerator and air conditioners.

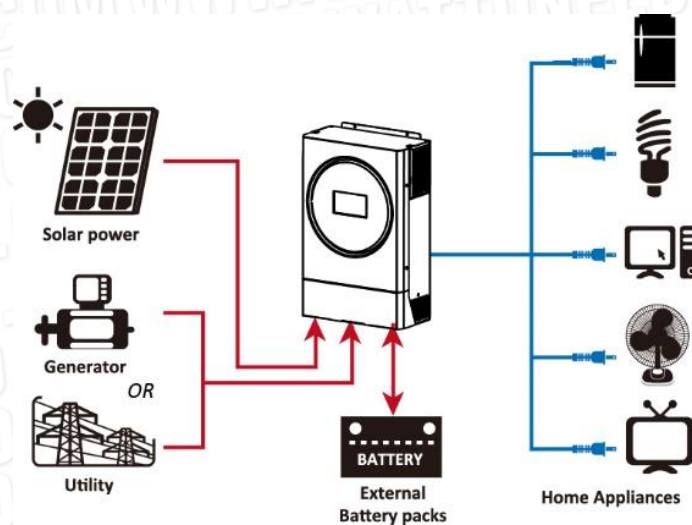
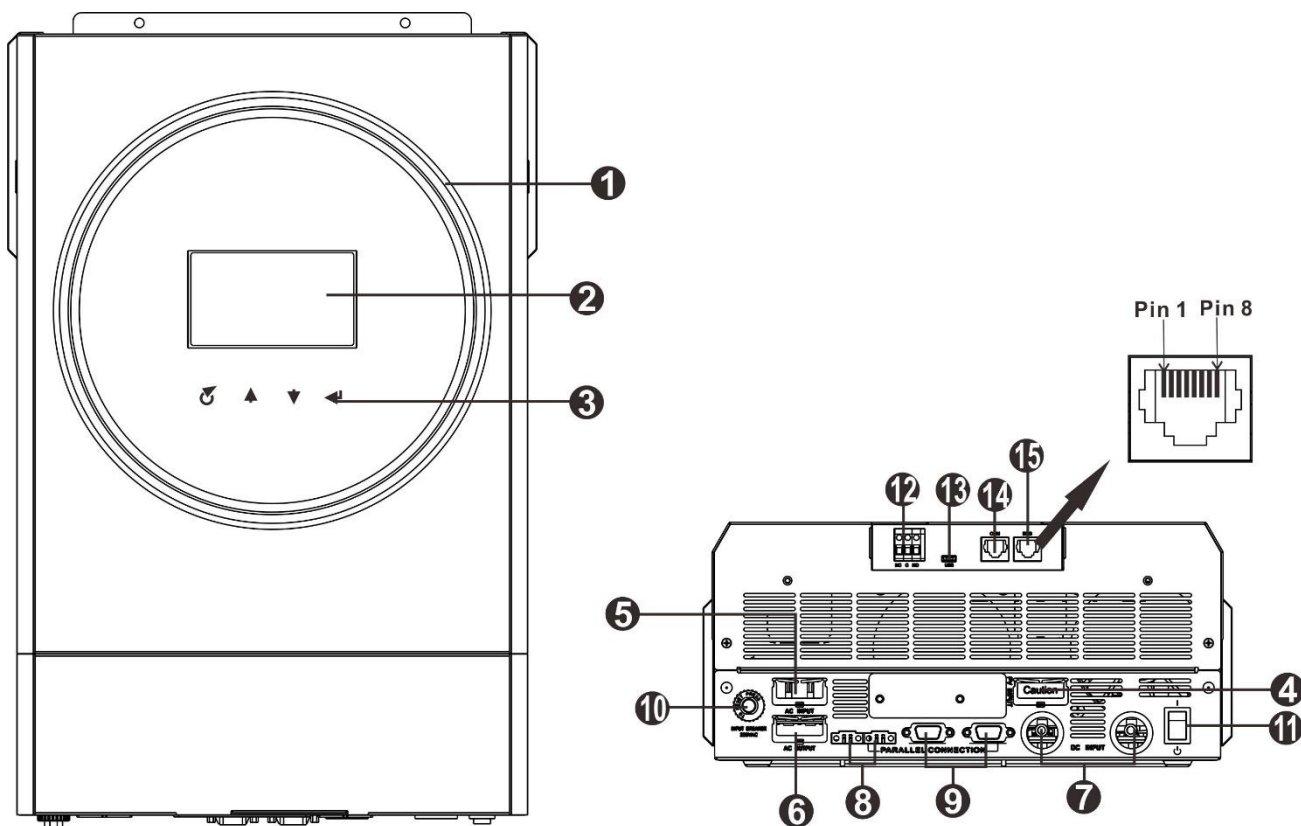

Figure 1 Basic hybrid PV System Overview

Product Overview



NOTE: For parallel installation and operation, please check *Appendix I*.

1. RGB LED ring (refer to LCD Setting section for the details)
2. LCD display
3. Touchable Function keys
4. PV connectors
5. AC input connectors
6. AC output connectors (Load connection)
7. Battery connectors
8. Current sharing port
9. Parallel communication port
10. Circuit breaker
11. Power switch
12. Dry contact
13. USB port as USB communication port and USB function port
14. RS-232 communication port
15. BMS communication port: CAN, RS-485 or RS-232

INSTALLATION

Unpacking and Inspection

Before installation, please inspect the unit. Be sure that nothing inside the package is damaged. You should have received the following items inside of package:



Preparation

Before connecting all wirings, please take off bottom cover by removing two screws as shown below.

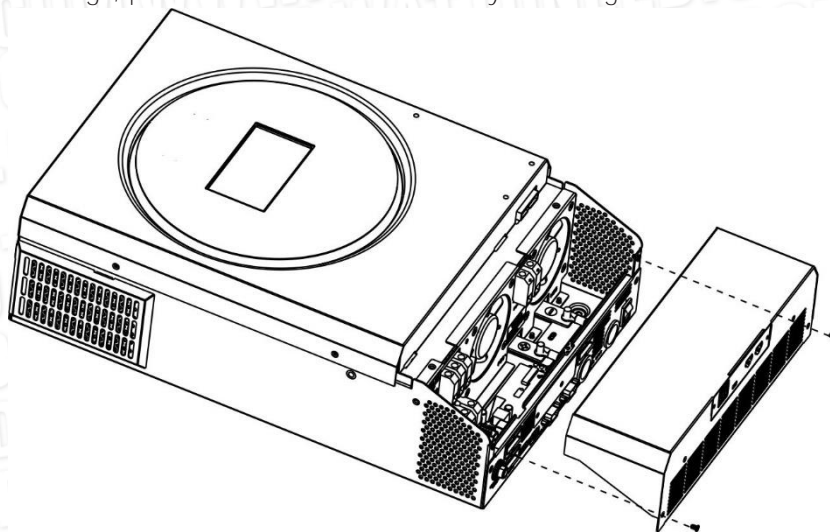

Mounting the Unit

Consider the following points before selecting where to install:

- Do not mount the inverter on flammable construction materials.
- Mount on a solid surface
- Install this inverter at eye level in order to allow the LCD display to be read at all times.
- The ambient temperature should be between -10°C and 50°C to ensure optimal operation.
- The recommended installation position is to be adhered to the wall vertically.
- Be sure to keep other objects and surfaces as shown in the right diagram to guarantee sufficient heat dissipation and to have enough space for removing wires.

⚠ SUITABLE FOR MOUNTING ON CONCRETE OR OTHER NON-COMBUSTIBLE SURFACE ONLY.

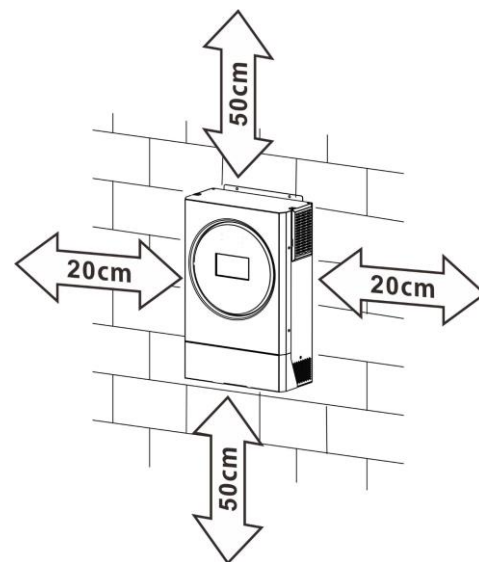

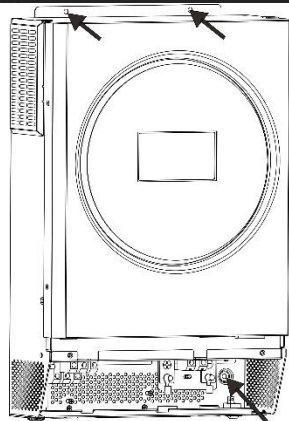

Battery Connection

CAUTION: For safety operation and regulation compliance, it's requested to install a separate DC over-current protector or disconnect device between battery and inverter. It may not be required to have a disconnect device in some applications, however, it's still required to have over-current protection installed. Please refer to typical amperage in below table as required fuse or breaker size.

WARNING! All wiring must be performed by a qualified personnel.
WARNING! It's very important for system safety and efficient operation to use appropriate cable for battery connection. To reduce risk of injury, please use the proper recommended cable and terminal size as below.

Ring terminal:

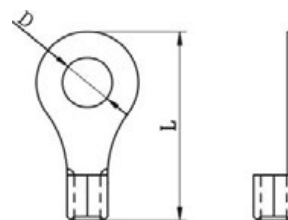



Recommended battery cable and terminal size:

Model	Typical Amperage	Battery Capacity	Wire Size	Ring Terminal			Torque Value
				Cable mm ²	Dimensions		
					D (mm)	L (mm)	
3.6KW	100A	200AH	1*4AWG	22	6.4	33.5	2~3 Nm
5.6KW	137A	200AH	1*2AWG or 2*6AWG	28	6.4	42.7	2~3 Nm

Please follow below steps to implement battery connection:

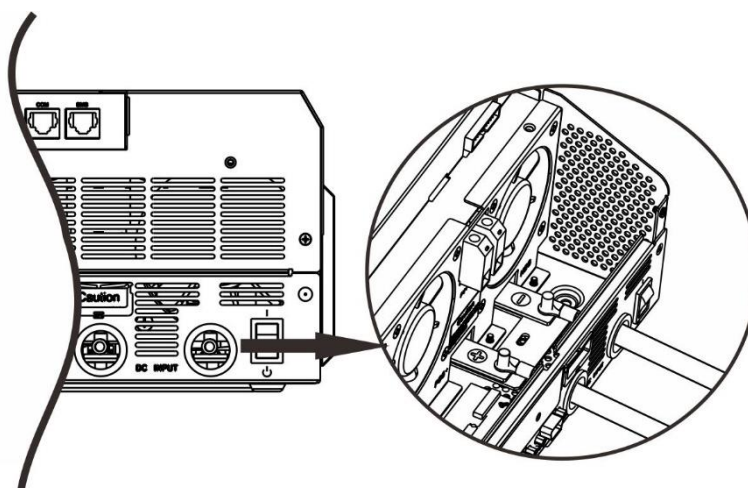
1. Assemble battery ring terminal based on recommended battery cable and terminal size.
2. Insert the ring terminal of battery cable flatly into battery connector of inverter and make sure the nuts are tightened with torque of 2-3 Nm. Make sure polarity at both the battery and the inverter/charge is correctly connected and ring terminals are tightly screwed to the battery terminals.



 **WARNING: Shock Hazard**
Installation must be performed with care due to high battery voltage in series.

 **CAUTION!!** Do not place anything between the flat part of the inverter terminal and the ring terminal. Otherwise, overheating may occur.
CAUTION!! Do not apply anti-oxidant substance on the terminals before terminals are connected tightly.
CAUTION!! Before making the final DC connection or closing DC breaker/disconnector, be sure positive (+) must be connected to positive (+) and negative (-) must be connected to negative (-).

AC Input/Output Connection

CAUTION!! Before connecting to AC input power source, please install a separate AC breaker between inverter and AC input power source. This will ensure the inverter can be securely disconnected during maintenance and fully protected from over current of AC input.

CAUTION!! There are two terminal blocks with "IN" and "OUT" markings. ENSURE that utility AC input is connected to IN and load AC to OUT and not the wrong way round and also that Line and Neutrals are connected correctly.

WARNING! All wiring must be performed by a qualified personnel.

WARNING! It's very important for system safety and efficient operation to use appropriate cable for AC input connection. To reduce risk of injury, please use the proper recommended cable size as below.

Suggested cable requirement for AC wires

Model	Gauge	Torque Value
3.6KW	12 AWG	1.2~ 1.6 Nm
5.6KW	10 AWG	1.2~ 1.6 Nm

Please follow below steps to implement AC input/output connection:

1. Before making AC input/output connection, be sure to open DC protector or disconnector first.
2. Remove insulation sleeve 10mm for six conductors. And shorten phase L and neutral conductor N 3 mm.
3. Insert AC input wires according to polarities indicated on terminal block and tighten the terminal screws.

Be sure to connect PE protective conductor (⊕) first.

⊕ → Ground (yellow-green)

L → LINE (brown or black)

N → Neutral (blue)

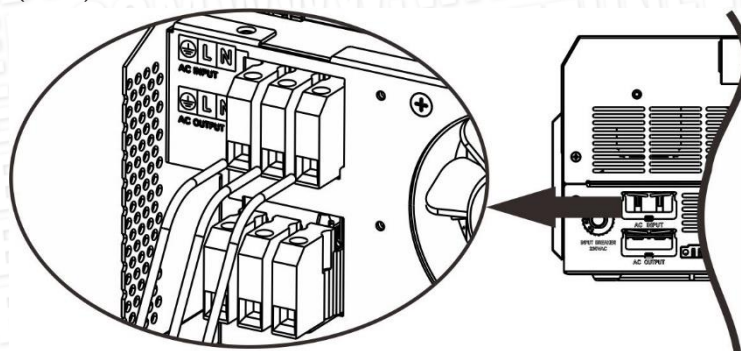

 **WARNING:**
Be sure that AC power source is disconnected before attempting to hardwire it to the unit.

4. Then, insert AC output wires according to polarities indicated on terminal block and tighten terminal screws. Be sure to connect PE protective conductor (⊕) first.

⊕ → Ground (yellow-green)

L → LINE (brown or black)

N → Neutral (blue)

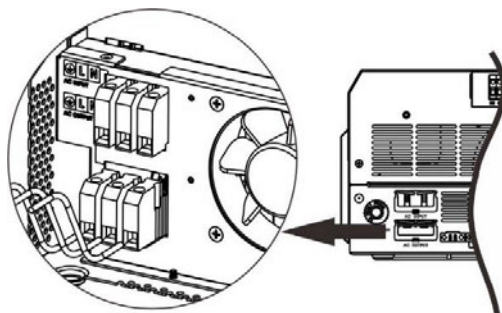

5. Make sure the wires are securely connected.

CAUTION: Important

Be sure to connect AC wires with correct polarity. If L and N wires are connected reversely, it may cause utility short-circuited when these inverters are worked in parallel operation.

CAUTION: Appliances such as air conditioner are required at least 2~3 minutes to restart because it's required to have enough time to balance refrigerant gas inside of circuits. If a power shortage occurs and recovers in a short time, it will cause damage to your connected appliances. To prevent this kind of damage, please check manufacturer of air conditioner if it's equipped with time-delay function before installation. Otherwise, this inverter/charger will trig overload fault and cut off output to protect your appliance but sometimes it still causes internal damage to the air conditioner.

PV Connection

CAUTION: Before connecting to PV modules, please install separately a DC circuit breaker between inverter and PV modules.

CAUTION: Please install a surge protection device between inverter and PV modules and the recommended voltage is 500V.

WARNING! Do switch off the inverter before connecting to PV modules. Otherwise, it will cause inverter damage.

WARNING! Do NOT connect negative and positive terminal of PV modules to the ground.

WARNING! All wiring must be performed by a qualified personnel.

WARNING! It's very important for system safety and efficient operation to use appropriate cable for PV module connection. To reduce risk of injury, please use the proper recommended cable size as below.

Model	Typical Amperage	Cable Size	Torque
3.6KW	18A	12AWG	1.2~1.6Nm
5.6KW	27A	10AWG	1.2~1.6Nm

PV Module Selection:

When selecting proper PV modules, please be sure to consider below parameters:

1. Open circuit Voltage (Voc) of PV modules not exceeds max. PV array open circuit voltage of inverter.
2. Open circuit Voltage (Voc) of PV modules should be higher than min. battery voltage.

Solar Charging Mode		
INVERTER MODEL	3.6KW	6.5KW
Max. PV Array Open Circuit Voltage	500 Vdc	450 Vdc
PV Array MPPT Voltage Range	120~430Vdc	
MPP Number	1	

Please follow below steps to implement PV module connection:

1. Remove insulation sleeve 10 mm for positive and negative conductors.
2. Check correct polarity of connection cable from PV modules and PV input connectors. Then, connect positive pole (+) of connection cable to positive pole (+) of PV input connector. Connect negative pole (-) of connection cable to negative pole (-) of PV input connector.

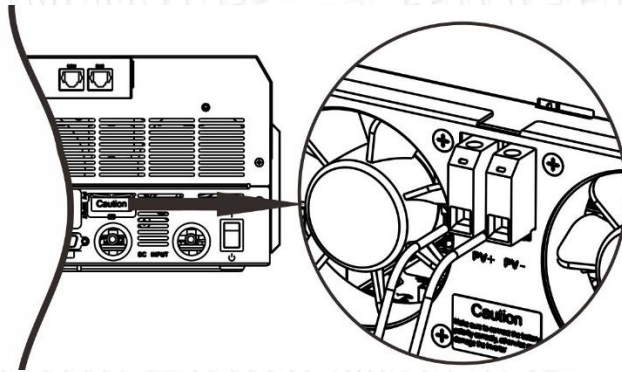
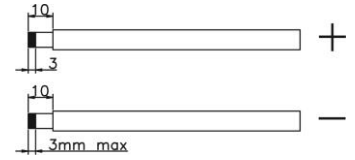

Recommended PV module Configuration

PV Module Spec. (reference)	Total solar input power	Solar input	Q'ty of modules
- 250Wp	1500W	6 pieces in series	6 pcs
- Vmp: 30.7Vdc	2000W	8 pieces in series	8 pcs
- Imp: 8.15A	2750W	11 pieces in series	11 pcs
- Voc: 37.4Vdc	3000W	6 pieces in series 2 strings in parallel	12 pcs
- Isc: 8.63A	4000W	8 pieces in series 2 strings in parallel	16 pcs
- Cells: 60	5000W	10 pieces in series 2 strings in parallel	20 pcs
	6000W	12 pieces in series 2 strings in parallel	24 pcs

Final Assembly

After connecting all wirings, please put bottom cover back by screwing two screws as shown below.

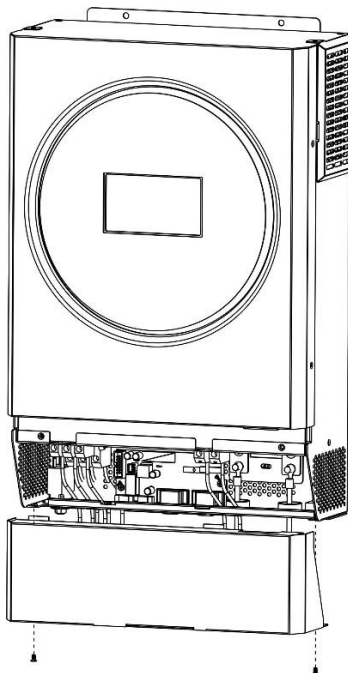

Communication Connection

Serial Connection

Please use the supplied serial cable to connect between the inverter and your PC. Install the monitoring software from the bundled CD and follow the on-screen instructions to complete your installation. For detailed software operation, refer to the software user manual on the bundled CD.

Wi-Fi Connection

This unit is equipped with a Wi-Fi transmitter. Wi-Fi transmitter can enable wireless communication between off-grid inverters and monitoring platform. Users can access and control the monitored inverter with downloaded APP. You may find "WatchPower" app from the Apple® Store or "WatchPower Wi-Fi" in Google® Play Store. All data loggers and parameters are saved in iCloud. For quick installation and operation, please refer to Appendix III - The Wi-Fi Operation Guide for details.

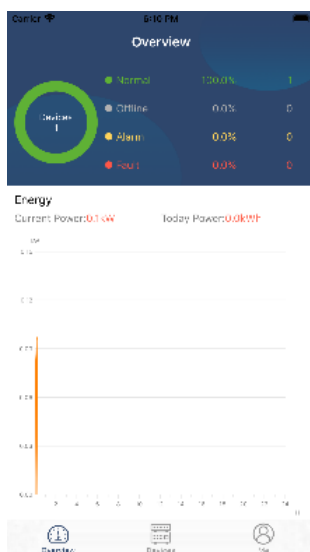

BMS Communication

It is recommended to purchase a special communication cable if you are connecting to Lithium-Ion battery banks. Please refer to Appendix II - BMS Communication Installation for details.

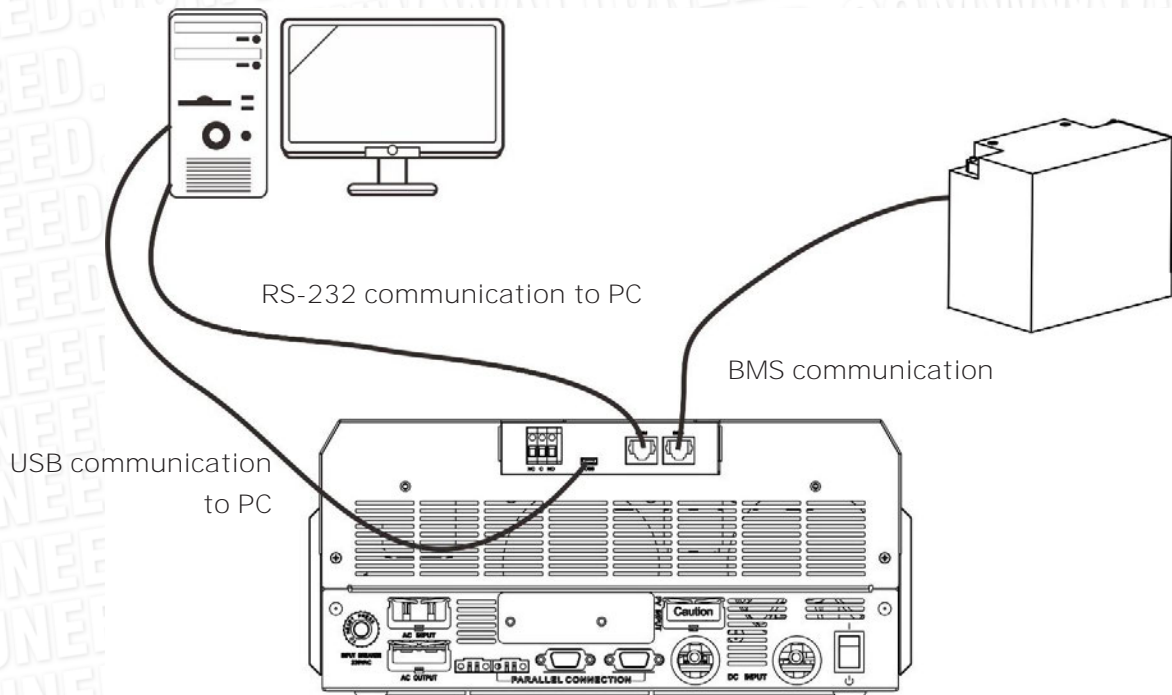

Dry Contact Signal

There is one dry contact (3A/250VAC) available on the rear panel. It could be used to deliver signal to external device when battery voltage reaches warning level.

Unit Status	Condition		Dry contact port: 		
			NC & C	NO & C	
Power Off	Unit is off and no output is powered.		Close	Open	
Power On	Output is powered from Battery power or Solar energy.	Program 01 set as USB (utility first) or SUB (solar first)	Battery voltage < Low DC warning voltage	Open	Close
			Battery voltage > Setting value in Program 13 or battery charging reaches floating stage	Close	Open
	Program 01 is set as SBU (SBU priority)		Battery voltage < Setting value in Program 12	Open	Close
			Battery voltage > Setting value in Program 13 or battery charging reaches floating stage	Close	Open

OPERATION

Power ON/OFF

Once the unit has been properly installed and the batteries are connected well, simply press On/Off switch to turn on the unit.

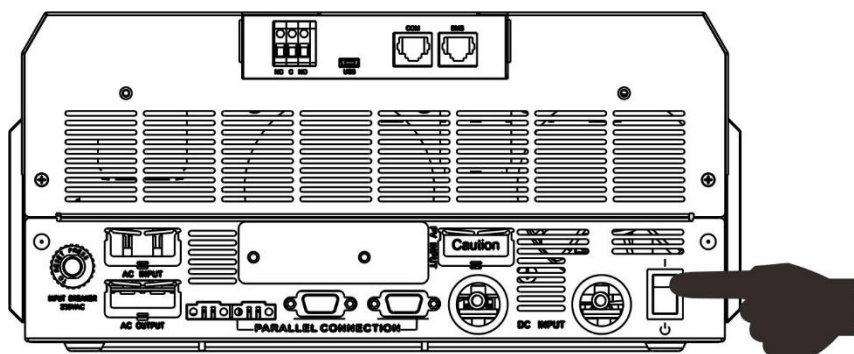



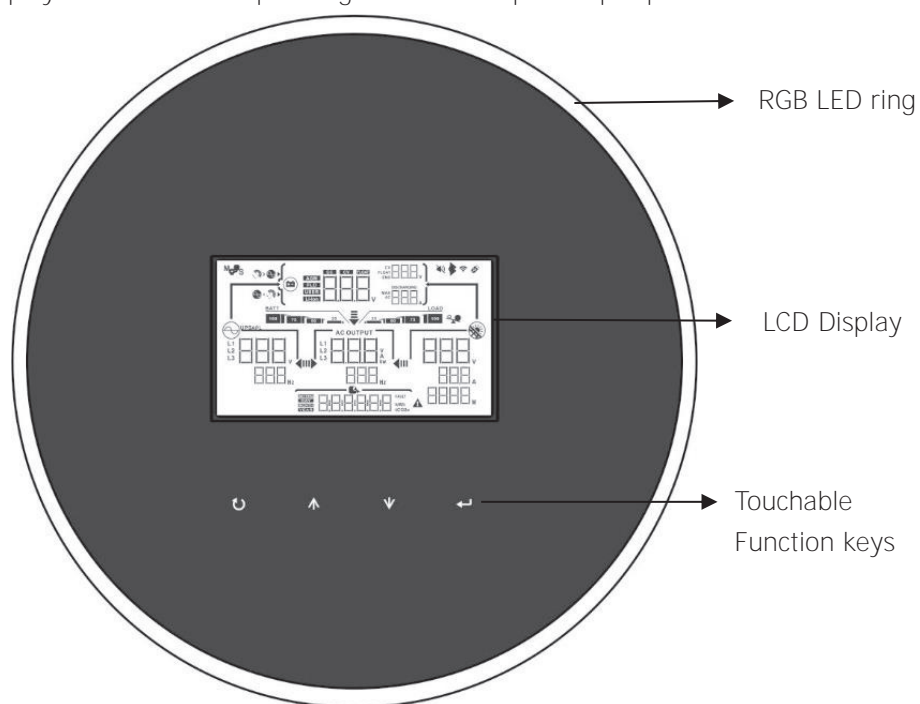

Operation and Display Panel

The operation and the LCD module, shown in the chart below, includes one RGB LED ring, four touchable function keys and a LCD display to indicate the operating status and input/output power information.









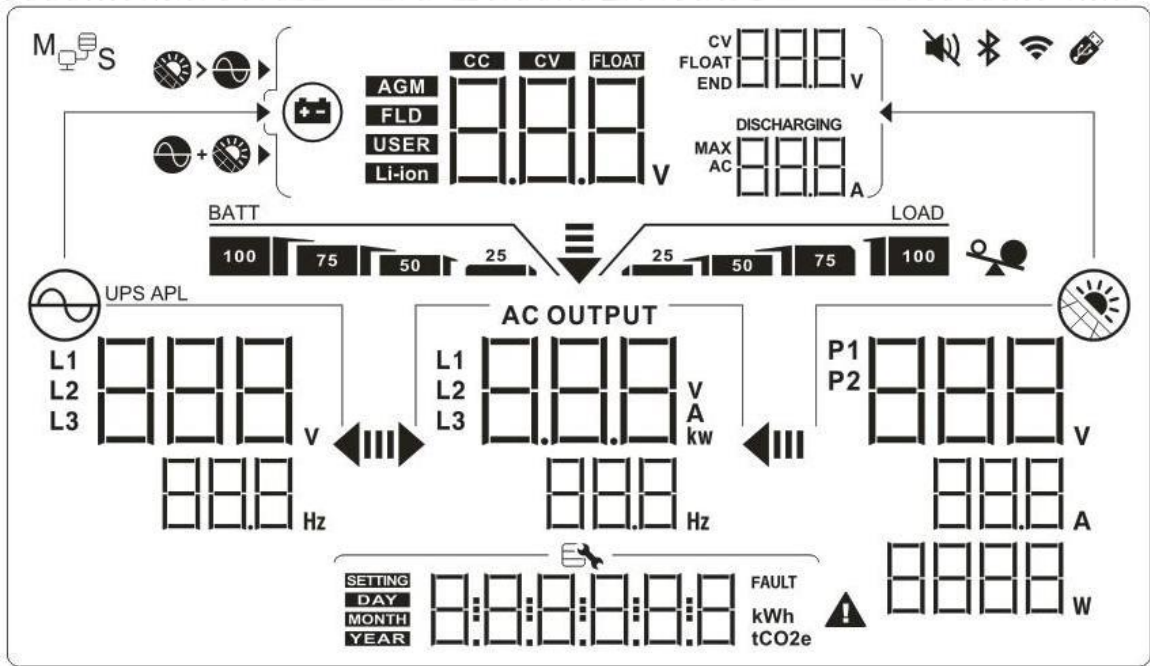



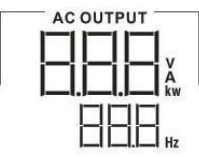

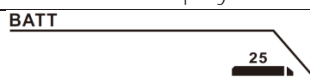



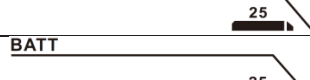

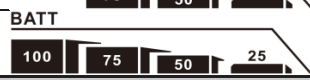

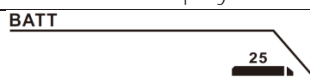



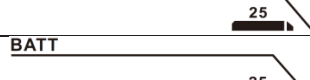

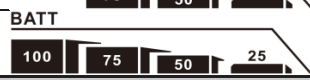

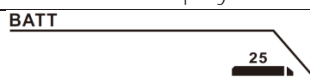



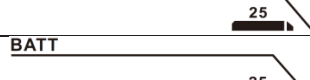

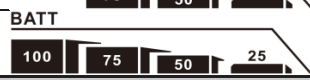







Touchable Function Keys









Function Key	Description	
	ESC	To exit the setting
	USB function selector	To enter USB function setting
	Up	To last selection
	Down	To next selection
	Enter	To confirm/enter the selection in setting mode

LCD Display Icons

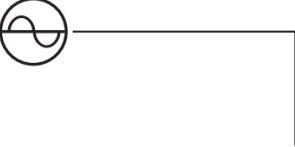
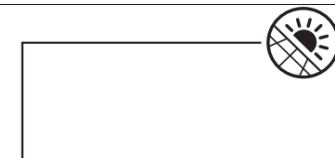

Icon	Function description
Input Source Information	
	Indicates the AC input voltage and frequency.
	Indicates the PV voltage, current and power.
	Indicates the battery voltage, charging stage, configured battery parameters, charging or discharging current.
Configuration Program and Fault Information	
	Indicates the setting programs.
	Indicates the warning and fault codes. Warning: flashing with warning code. Fault: lighting with fault code.

Output Information																							
	Indicate the output voltage, load in VA, load in Watt and output frequency.																						
Battery Information																							
BATT 	Indicates battery level in battery mode and charging status in line mode by 0-24%, 25-49%, 50-74% and 75-100%.																						
When battery is charging, it will present battery charging status.																							
<table border="1"> <thead> <tr> <th>Status</th> <th>Battery voltage</th> <th>LCD Display</th> </tr> </thead> <tbody> <tr> <td rowspan="3">Constant Current mode / Constant Voltage mode</td> <td>< 2V/cell</td> <td>4 bars will flash in turns.</td> </tr> <tr> <td>2 ~ 2.083V/cell</td> <td>The right bar will be on and the other three bars will flash in turns.</td> </tr> <tr> <td>2.083 ~ 2.167V/cell</td> <td>The right two bars will be on and the other two bars will flash in turns.</td> </tr> <tr> <td> <td>> 2.167 V/cell</td> <td>The right three bars will be on and the left bar will flash.</td> </td></tr> <tr> <td colspan="2">Floating mode. Batteries are fully charged.</td> <td>4 bars will be on.</td> </tr> </tbody> </table>	Status	Battery voltage	LCD Display	Constant Current mode / Constant Voltage mode	< 2V/cell	4 bars will flash in turns.	2 ~ 2.083V/cell	The right bar will be on and the other three bars will flash in turns.	2.083 ~ 2.167V/cell	The right two bars will be on and the other two bars will flash in turns.	<td>> 2.167 V/cell</td> <td>The right three bars will be on and the left bar will flash.</td>	> 2.167 V/cell	The right three bars will be on and the left bar will flash.	Floating mode. Batteries are fully charged.		4 bars will be on.							
Status	Battery voltage	LCD Display																					
Constant Current mode / Constant Voltage mode	< 2V/cell	4 bars will flash in turns.																					
	2 ~ 2.083V/cell	The right bar will be on and the other three bars will flash in turns.																					
	2.083 ~ 2.167V/cell	The right two bars will be on and the other two bars will flash in turns.																					
<td>> 2.167 V/cell</td> <td>The right three bars will be on and the left bar will flash.</td>	> 2.167 V/cell	The right three bars will be on and the left bar will flash.																					
Floating mode. Batteries are fully charged.		4 bars will be on.																					
In battery mode, it will present battery capacity.																							
<table border="1"> <thead> <tr> <th>Load Percentage</th> <th>Battery Voltage</th> <th>LCD Display</th> </tr> </thead> <tbody> <tr> <td rowspan="4">Load > 50%</td> <td>< 1.85V/cell</td> <td></td> </tr> <tr> <td>1.85V/cell ~ 1.933V/cell</td> <td></td> </tr> <tr> <td>1.933V/cell ~ 2.017V/cell</td> <td></td> </tr> <tr> <td>> 2.017V/cell</td> <td></td> </tr> <tr> <td rowspan="4">Load < 50%</td> <td>< 1.892V/cell</td> <td></td> </tr> <tr> <td>1.892V/cell ~ 1.975V/cell</td> <td></td> </tr> <tr> <td>1.975V/cell ~ 2.058V/cell</td> <td></td> </tr> <tr> <td>> 2.058V/cell</td> <td></td> </tr> </tbody> </table>	Load Percentage	Battery Voltage	LCD Display	Load > 50%	< 1.85V/cell		1.85V/cell ~ 1.933V/cell		1.933V/cell ~ 2.017V/cell		> 2.017V/cell		Load < 50%	< 1.892V/cell		1.892V/cell ~ 1.975V/cell		1.975V/cell ~ 2.058V/cell		> 2.058V/cell			
Load Percentage	Battery Voltage	LCD Display																					
Load > 50%	< 1.85V/cell																						
	1.85V/cell ~ 1.933V/cell																						
	1.933V/cell ~ 2.017V/cell																						
	> 2.017V/cell																						
Load < 50%	< 1.892V/cell																						
	1.892V/cell ~ 1.975V/cell																						
	1.975V/cell ~ 2.058V/cell																						
	> 2.058V/cell																						
Load Information																							
	Indicates overload.																						
	Indicates the load level by 0-24%, 25-49%, 50-74% and 75-100%. <table border="1"> <thead> <tr> <th>0%~24%</th> <th>25%~49%</th> </tr> </thead> <tbody> <tr> <td></td> <td></td> </tr> <tr> <th>50%~74%</th> <th>75%~100%</th> </tr> <tr> <td></td> <td></td> </tr> </tbody> </table>		0%~24%	25%~49%			50%~74%	75%~100%															
0%~24%	25%~49%																						
																							
50%~74%	75%~100%																						
																							
Charger Source Priority Setting Display																							
	Indicates setting program 16 "Charger source priority" is selected as "Solar first".																						
	Indicates setting program 16 "Charger source priority" is selected as "Solar and Utility".																						





	Indicates setting program 16 "Charger source priority" is selected as "Solar only".
Output source priority setting display	
	Indicates setting program 01 "Output source priority" is selected as "Utility first".
	Indicates setting program 01 "Output source priority" is selected as "Solar first".
	Indicates setting program 01 "Output source priority" is selected as "SBU".
AC Input Voltage Range Setting Display	
UPS	Indicates setting program 03 is selected as "UPS". The acceptable AC input voltage range will be within 170-280VAC.
APL	Indicates setting program 03 is selected as "APL". The acceptable AC input voltage range will be within 90-280VAC.
Operation Status Information	
	Indicates unit connects to the mains.
	Indicates unit connects to the PV panel.
AGM FLD USER Li-ion	Indicates battery type.
	Indicates parallel operation is working.
	Indicates unit alarm is disabled.
	Indicates Wi-Fi transmission is working.
	Indicates USB disk is connected.

LCD Setting

General Setting

After pressing and holding "←" button for 3 seconds, the unit will enter the setting mode. Press "▲" or "▼" button to select setting programs. Press "←" button to confirm you selection or "↻" button to exit.



Setting Programs:

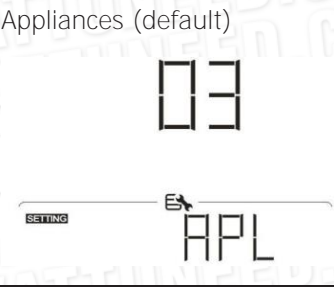
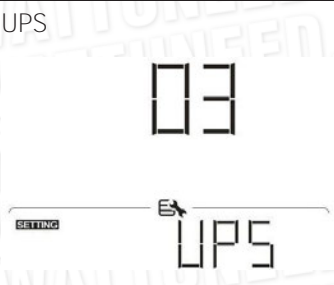
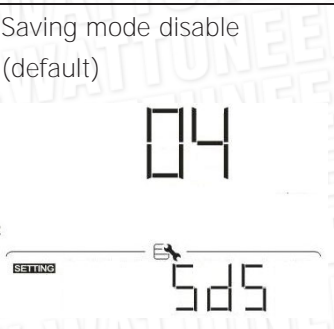
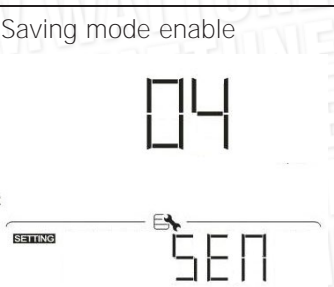
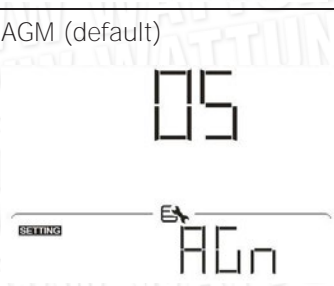
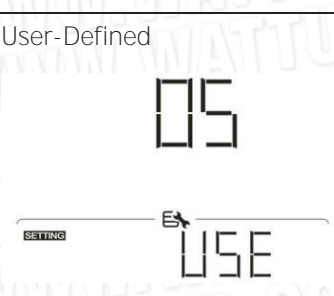

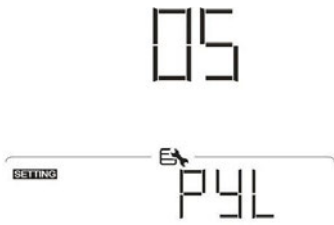
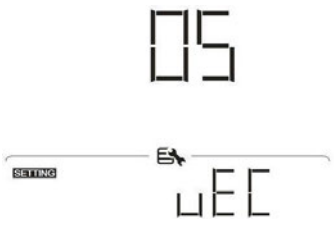
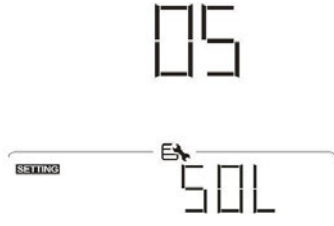
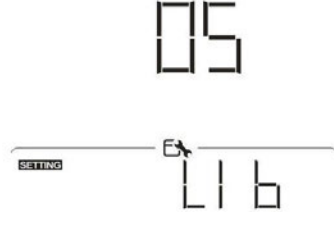
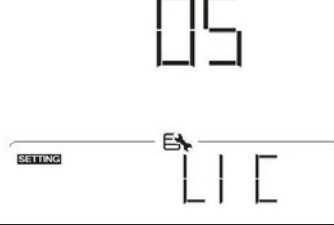
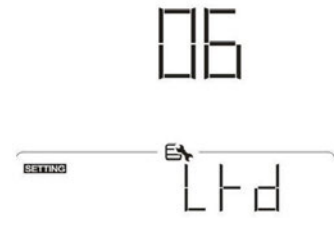
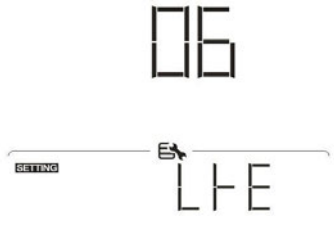
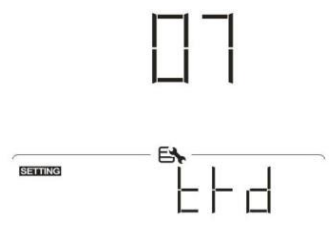
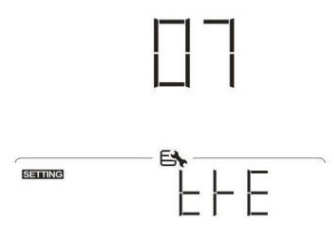



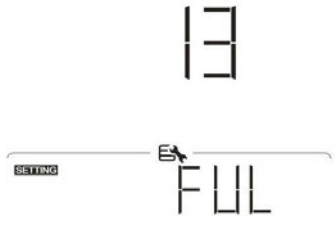
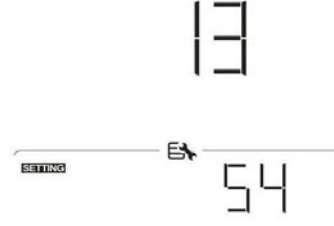
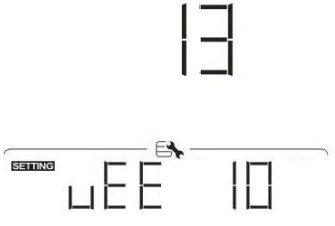
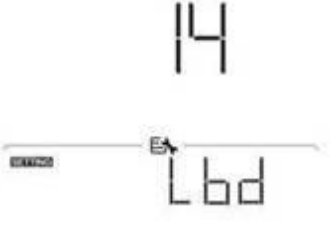
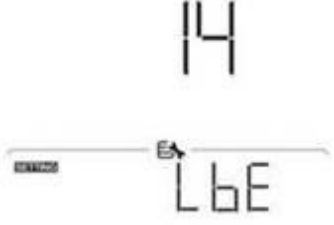
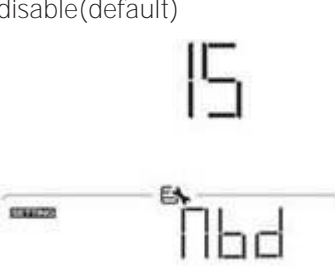
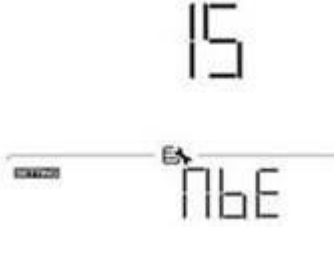
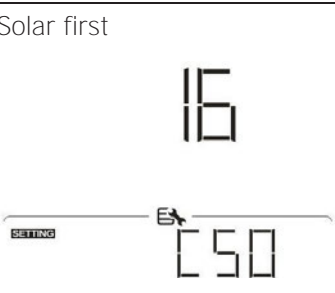



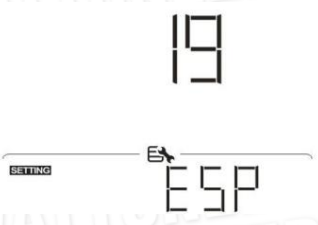

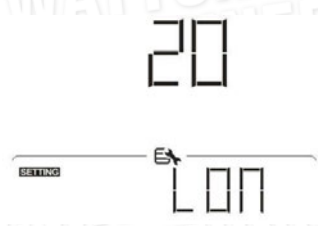

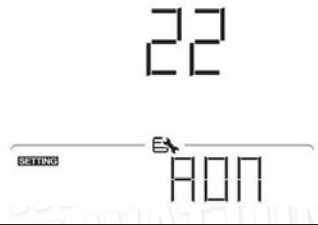
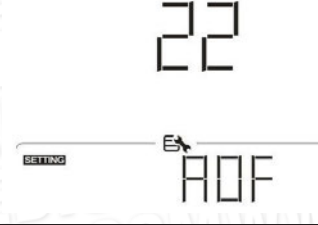
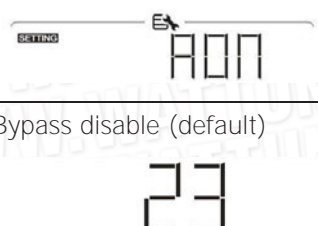
Program	Description	Selectable option	
00	Exit setting mode	Escape	
		00	
			
01	Output source priority: To configure load power source priority	Utility first (default)	Utility will provide power to the loads as first priority. Solar and battery energy will provide power to the loads only when utility power is not available.
		01	
			
		Solar first	Solar energy provides power to the loads as first priority. If solar energy is not sufficient to power all connected loads, Utility energy will supply power to the loads at the same time.
		01	
			
		SBU priority	Solar energy provides power to the loads as first priority. If solar energy is not sufficient to power all connected loads, battery energy will supply power to the loads at the same time. Utility provides power to the loads only when battery voltage drops to either low-level warning voltage or the setting point in program 12.
		01	
			
02	Maximum charging current: To configure total charging current for solar and utility chargers. (Max. charging current = utility charging current + solar charging current)	60A (default)	Setting range is from 10A to 100A for 3.6kw model and from 10A to 120A for 5.6kw model. Increment of each click is 10A.
		02	
			

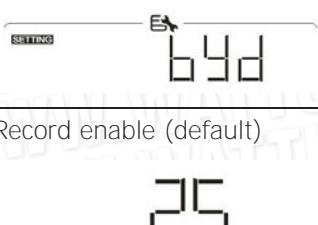

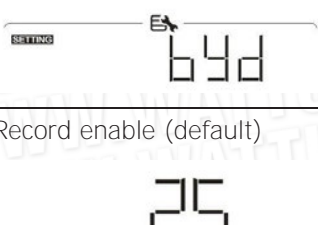



03	AC input voltage range	Appliances (default)		If selected, acceptable AC input voltage range will be within 90-280VAC.
		UPS		If selected, acceptable AC input voltage range will be within 170-280VAC.
04	Power saving mode enable/disable	Saving mode disable (default)		If disabled, no matter connected load is low or high, the on/off status of inverter output will not be effected.
		Saving mode enable		If enabled, the output of inverter will be off when connected load is pretty low or not detected.
05	Battery type	AGM (default)		Flooded
		User-Defined		If "User-Defined" is selected, battery charge voltage and low DC cut-off voltage can be set up in program 26, 27 and 29.



05	Battery type	Pylontech battery 	If selected, programs of 02, 26, 27 and 29 will be automatically set up. No need for further setting.
		WECO battery 	If selected, programs of 02, 12, 26, 27 and 29 will be auto-configured per battery supplier recommended. No need for further adjustment.
		Soltaro battery 	If selected, programs of 02, 26, 27 and 29 will be automatically set up. No need for further setting.
		Lib-protocol compatible battery 	Select "Lib" if using Lithium battery compatible to Lib protocol. If selected, programs of 02, 26, 27 and 29 will be automatically set up. No need for further setting.
		3 rd party Lithium battery 	If selected, programs of 02, 26, 27 and 29 will be automatically set up. No need for further setting. Please contact the battery supplier for installation procedure.
06	Auto restart when overload occurs	Restart disable (default) 	Restart enable 
		Restart disable (default) 	Restart enable 



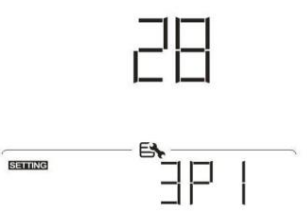

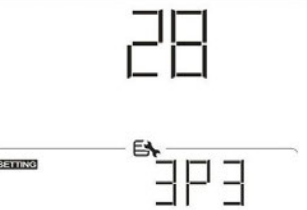
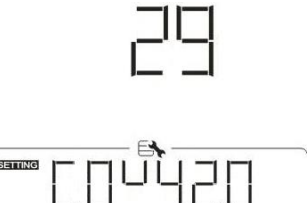

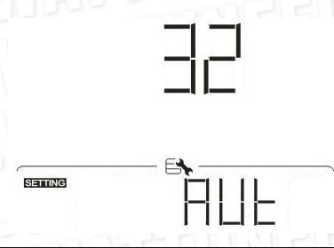
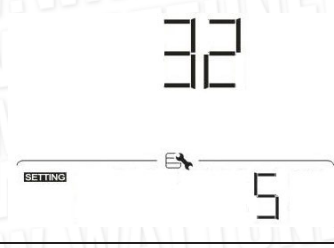
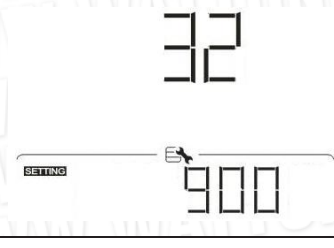
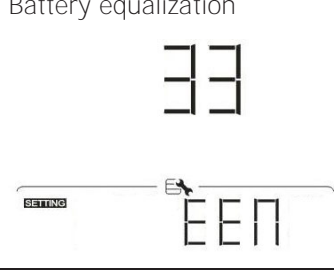
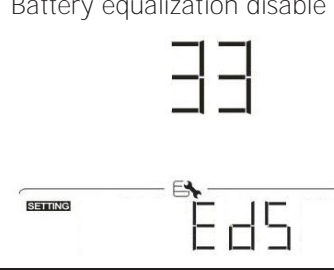

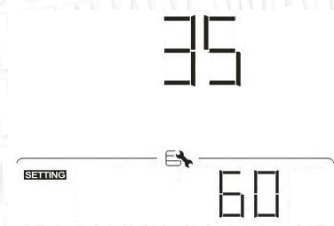











08	Output voltage	220V 08 SETTING 220	230V(default) 08 SETTING 230
		240V 08 SETTING 240	
09	Output frequency	50Hz (default) 09 SETTING 50	60Hz 09 SETTING 60
11	Maximum utility charging current Note: If setting value in program 02 is smaller than that in program in 11, the inverter will apply charging current from program 02 for utility charger.	30A (default) 11 SETTING 30	For 3.6K model, setting range is from 2A, then 10A to 100A. For 5.6K model, setting range is from 2A, then 10A to 120A. Increment of each click is 10A.
12	Setting voltage point back to utility source when selecting "SBU" (SBU priority) in program 01.	46V (default) 12 SETTING 46	Setting range is from 44V to 57V. Increment of each click is 1V. On certain versions of the inverter, the settings may be in percentage; in this case, the correct percentage to enter is 20%.
		5% (default) 12 SETTING 5	If "WECO battery" is selected in program 05, the setting value will be fixed at 5% of connected battery capacity.

13	Setting voltage point back to battery mode when selecting "SBU" (SBU priority) in program 01.	Setting range is FUL and from 48V to 64V. Increment of each click is 1V.	
		Battery fully charged 	54V (default) On certain versions of the inverter, the settings may be in percentage; in this case, the correct percentage to enter is 80%. 
		10% (default) 	If "WECO battery" is selected in program 5, this parameter value will be displayed in percentage and value setting is based on battery capacity percentage. The setting range is from 10%to 100%. Increment of each click is 5%.
14	Lithium battery turn-on when the device is powered on.	Auto turn-on disable(default) 	Auto turn-on enable 
		Lithium battery turn-on immediately NOTE: This setting is effective only when program 14 is set as "enable". 	Turn-on immediately enable 
16	Charger source priority: To configure charger source priority	If this inverter/charger is working in Line, Standby or Fault mode, charger source can be programmed as below:	
		Solar first 	Solar energy will charge battery as first priority. Utility will charge battery only when solar energy is not available.
		Solar and Utility (default) 	Solar energy and utility will charge battery at the same time.



19	Auto return to default display screen	Return to default display screen (default)		If selected, no matter how users switch display screen, it will automatically return to default display screen (Input voltage /output voltage) after no button is pressed for 1 minute.	
		Stay at latest screen		If selected, the display screen will stay at latest screen user finally switches.	
20	Backlight control	Backlight on (default)		Backlight off	
		Alarm on (default)		Alarm off	
22	Beeps while primary source is interrupted	Alarm on (default)		Alarm off	
		Bypass disable (default)		Bypass enable	
23	Overload bypass: When enabled, the unit will transfer to line mode if overload occurs in battery mode.	Bypass disable (default)		Bypass enable	
		Record enable (default)		Record disable	
25	Record Fault code	Record enable (default)		Record disable	

26	Bulk charging voltage (C.V voltage)	56.4V (default) 	If "User-Defined" is selected in program 5, this program can be set up. Setting range is from 48.0V to 64.0V. Increment of each click is 0.1V.
27	Floating charging voltage	54V (default) 	If "User-Defined" is selected in program 5, this program can be set up. Setting range is from 48.0V to 64.0V. Increment of each click is 0.1V.
28	AC output mode *This setting is only available when the inverter is in standby mode (Switch off).	Single: This inverter is used in single phase application. 	Parallel: This inverter is operated in parallel system. 
		L1 phase: 	L2 phase: 
		L3 phase: 	
29	Low DC cut-off voltage	42.0V (default) 	If "User-Defined" is selected in program 5, this program can be set up. Setting range is from 40.0V to 54.0V. Increment of each click is 0.1V. Low DC cut-off voltage will be fixed to setting value no matter what percentage of load is connected. On certain versions of the inverter, the settings may be in percentage; in this case, the correct percentage to enter is 10%.

		If "User-Defined" is selected in program 05, this program can be set up.	
		Automatically (Default): 	If selected, inverter will judge this charging time automatically.
32	Bulk charging time (C.V stage)	5 min 	The setting range is from 5 min to 900 min. Increment of each click is 5 min.
		900 min 	
33	Battery equalization	If "Flooded" or "User-Defined" is selected in program 05, this program can be set up.	
		Battery equalization 	Battery equalization disable (Default) 
34	Battery equalization voltage	58.4V (Default) 	Setting range is from 48V to 64V. Increment of each click is 0.1V.
		60min (Default) 	Setting range is from 5min to 900min. Increment of each click is 5min.
35	Battery equalized time		

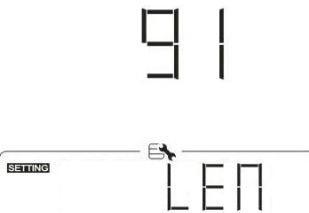
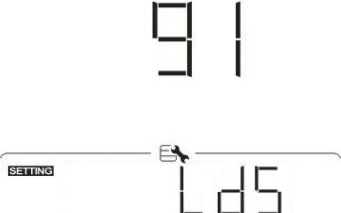
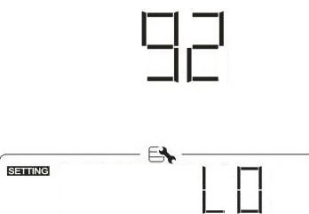
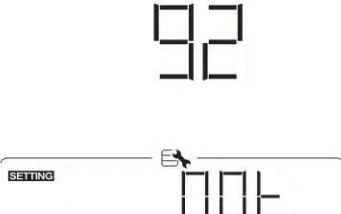
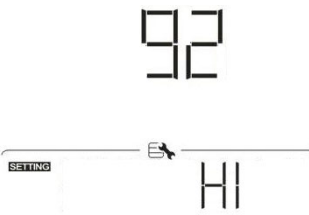
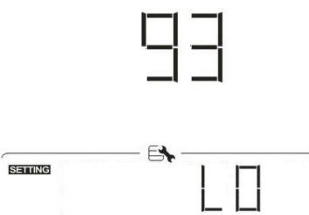
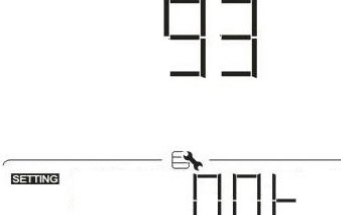
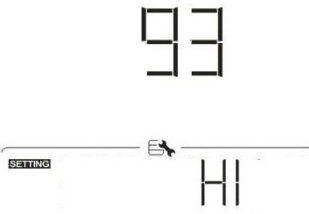

36	Battery equalized timeout	120min (Default)  	Setting range is from 5min to 900 min. Increment of each click is 5 min.
37	Equalization interval	30days (Default)  	Setting range is from 0 to 90 days. Increment of each click is 1 day
39	Equalization activated immediately	Enable  	Disable (Default)   <p>If equalization function is enabled in program 33, this program can be set up. If "Enable" is selected in this program, it's to activate battery equalization immediately and LCD main page will shows "E9". If "Disable" is selected, it will cancel equalization function until next activated equalization time arrives based on program 37setting. At this time, "E9" will not be shown in LCD main page.</p>
40	Reset all stored data for PV generated power and output load energy	Not reset (Default)  	Reset  
83	Erase all data log	Not reset (Default)  	Reset  
84	Data log recorded interval *The maximum data log number is 1440. If it's over 1440, it will re-write the first log.	3 minutes  	5 minutes  

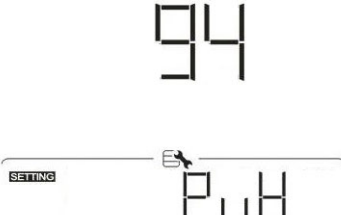
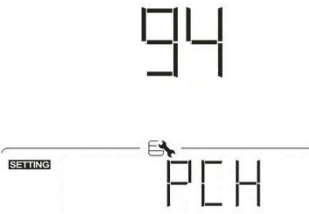
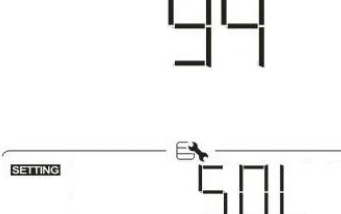

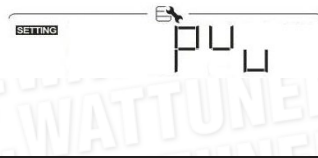
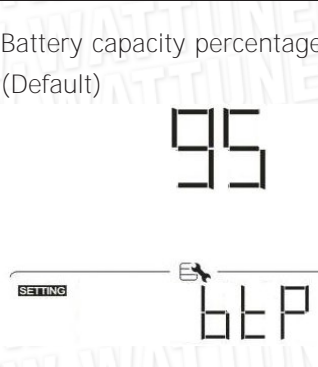
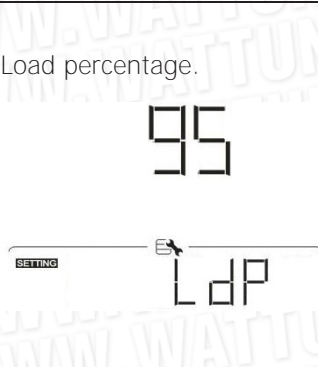
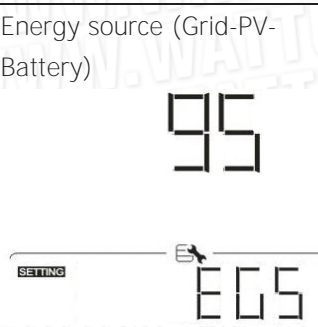
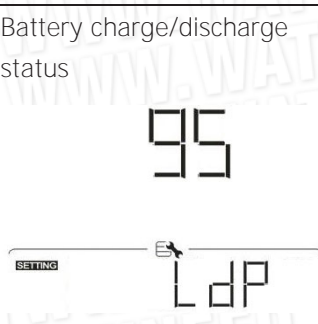

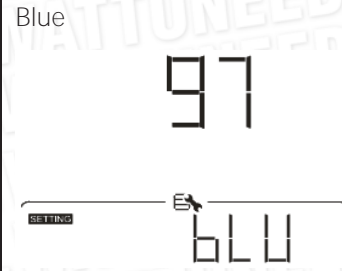

		10 minutes (default) 84 SETTING 10	20 minutes 84 SETTING 20
		30 minutes 84 SETTING 30	60 minutes 84 SETTING 60
85	Time setting – Minute	85 SETTING 0	For minute setting, the range is from 0 to 59.
86	Time setting – Hour	86 SETTING HOUR 0	For hour setting, the range is from 0 to 23.
87	Time setting– Day	87 SETTING DAY 1	For day setting, the range is from 1 to 31.
88	Time setting– Month	88 SETTING MONTH 1	For month setting, the range is from 1 to 12.
89	Time setting – Year	89 SETTING YEAR 20	For year setting, the range is from 17 to 99.

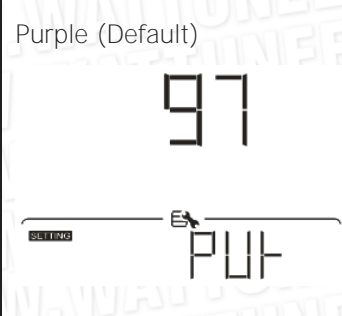
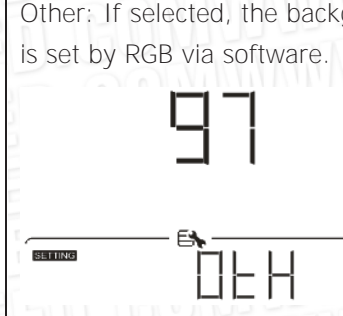
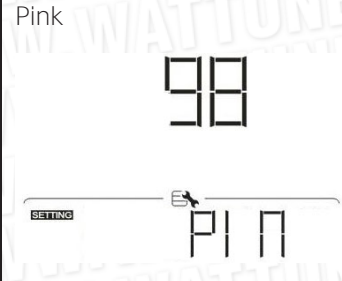
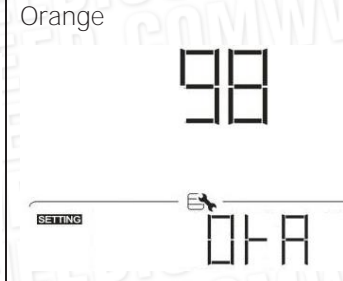
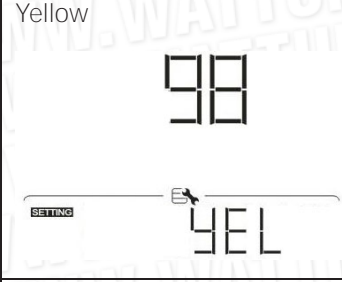
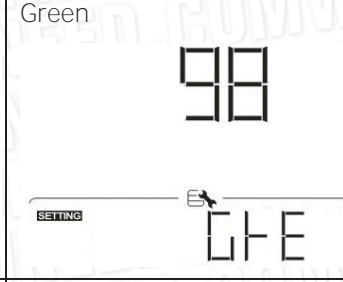
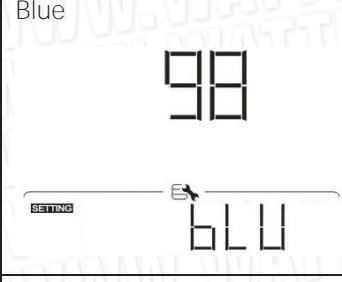
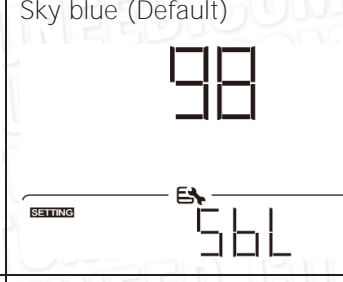
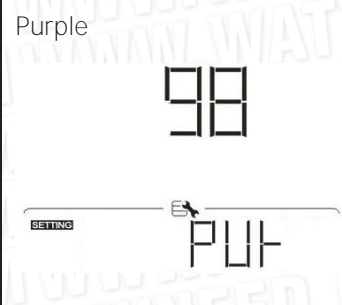
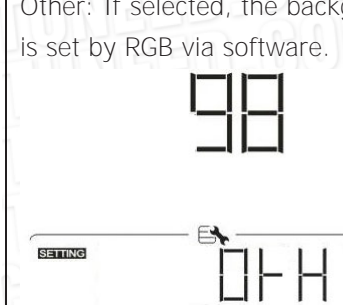
91	On/Off control for RGB LED *It's necessary to enable this setting to activate RGB LED lighting function.	Enabled (default) 	Disable 
92	Brightness of RGB LED	Low 	Normal (default) 
		High 	
93	Lighting speed of RGB LED	Low 	Normal (default) 
		High 	
94	RGB LED effects	Power cycling 	Power wheel 
		Power chasing 	Solid on (Default) 

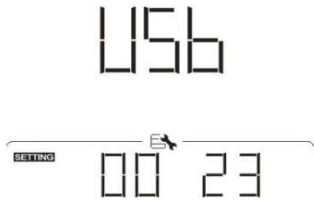
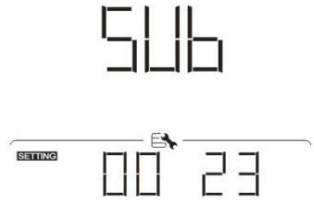
<p>95</p> <p>Data presentation for data color *Energy source (Grid-PV-Battery) and battery charge/discharge status only available when RGB LED effects is set to Solid on.</p>	<p>Solar input power in watt</p> <p>95</p> 	<p>LED lighting portion will be changed by the percentage of solar input power and nominal PV power.</p> <p>If "Solid on" is selected in #38, LED ring will light up with background color setting in #40.</p> <p>If "Power wheel" is selected in #38, LED ring will light up in 4 levels.</p> <p>If "cycling" or "chasing" is selected in #38, LED ring will light up in 12 levels.</p>
	<p>Battery capacity percentage (Default)</p> <p>95</p> 	<p>LED lighting portion will be changed by battery capacity percentage.</p> <p>If "Solid on" is selected in #38, LED ring will light up with background color setting in #40.</p> <p>If "Power wheel" is selected in #38, LED ring will light up in 4 levels.</p> <p>If "cycling" or "chasing" is selected in #38, LED ring will light up in 12 levels.</p>
	<p>Load percentage.</p> <p>95</p> 	<p>LED lighting portion will be changed by load percentage.</p> <p>If "Solid on" is selected in #38, LED ring will light up with background color setting in #40.</p> <p>If "Power wheel" is selected in #38, LED ring will light up in 4 levels.</p> <p>If "cycling" or "chasing" is selected in #38, LED ring will light up in 12 levels.</p>
	<p>Energy source (Grid-PV-Battery)</p> <p>95</p> 	<p>If selected, the LED color will be background color setting in #40 in AC mode. If PV power is active, the LED color will be data color setting in #41. If the remaining status, the LED color will be set in #42.</p>
	<p>Battery charge/discharge status</p> <p>95</p> 	<p>If selected, the LED color will be background color setting in #40 in battery charging status. The LED color will be data color setting in #41 in battery discharging status.</p>

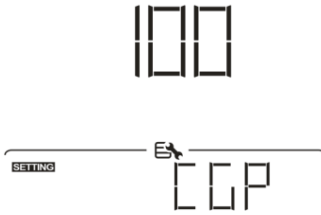

96	Background color of RGB LED	Pink 96 SETTING → PIN	Orange 96 SETTING → ORA
		Yellow 96 SETTING → YEL	Green 96 SETTING → GFE
		Blue 96 SETTING → BLU	Sky blue (Default) 96 SETTING → SBL
		Purple 96 SETTING → PUR	Other: If selected, the background color is set by RGB via software. 96 SETTING → OTH
97	Data Color for RGB LED	Pink 97 SETTING → PIN	Orange 97 SETTING → ORA
		Yellow 97 SETTING → YEL	Green 97 SETTING → GFE

97	Data Color for RGB LED	Blue	Sky blue
			
98	Background color of RGB LED *Only available when program 95 is set as "EGS" Energy source (Grid-PV-Battery).	Purple (Default)	Other: If selected, the background color is set by RGB via software.
			
98	Background color of RGB LED *Only available when program 95 is set as "EGS" Energy source (Grid-PV-Battery).	Pink	Orange
			
		Yellow	Green
			
98	Background color of RGB LED *Only available when program 95 is set as "EGS" Energy source (Grid-PV-Battery).	Blue	Sky blue (Default)
			
98	Background color of RGB LED *Only available when program 95 is set as "EGS" Energy source (Grid-PV-Battery).	Purple	Other: If selected, the background color is set by RGB via software.
			







99	<p>Timer Setting for Output Source Priority</p> <div style="text-align: center;">  </div>	<p>Once access this program, it will show "OPP" in LCD. Press "←" button to select timer setting for output source priority. There are three timers to set up. Press "▲" or "▼" button to select specific timer option. Then, press "←" to confirm timer option. Press "▲" or "▼" button to adjust starting time first and the setting range is from 00 to 23. Increment of each click is one hour. Press "←" to confirm starting time setting. Next, the cursor will jump to right column to set up end time. Once end time is set completely, press "←" to confirm all setting.</p>	
		<p>Utility first timer</p> <div style="text-align: center;">  </div>	<p>Solar first timer</p> <div style="text-align: center;">  </div>
		<p>SBU priority timer</p> <div style="text-align: center;">  </div>	
100	<p>Timer Setting for Charger Source Priority</p> <div style="text-align: center;">  </div>	<p>Once access this program, it will show "CGP" in LCD. Press "←" button to select timer setting for charger source priority. There are three timers to set up. Press "▲" or "▼" button to select specific timer option. Then, press "←" to confirm timer option. Press "▲" or "▼" button to adjust starting time first and the setting range is from 00 to 23. Increment of each click is one hour. Press "←" to confirm starting time setting. Next, the cursor will jump to right column to set up end time. Once end time is set completely, press "←" to confirm all setting.</p>	
		<p>Solar first</p> <div style="text-align: center;">  </div>	<p>Solar and utility</p> <div style="text-align: center;">  </div>
		<p>Only solar</p> <div style="text-align: center;">  </div>	

USB Function Setting

There are three USB function setting such as firmware upgrade, data log export and internal parameter re-write from the USB disk. Please follow below procedure to execute selected USB function setting.

Procedure	LCD Screen
Step 1: Insert an OTG USB disk into the USB port (11).	
Step 2: Press "↻" button to enter USB function setting.	

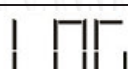
Step 3: Please select setting program by following the procedure.

Program#	Operation Procedure	LCD Screen
Upgrade firmware	After entering USB function setting, press "←" button to enter "upgrade firmware" function. This function is to upgrade inverter firmware. If firmware upgrade is needed, please check with your dealer or installer for detail instructions.	
Re-write internal parameters	After entering USB function setting, press "▼" button to switch to "Re-write internal parameters" function. This function is to overwrite all parameter settings (TEXT file) with settings in the USB disk from a previous setup or to duplicate inverter settings. Please check with your dealer or installer for detail instructions.	
Export data log	After entering USB function setting, press "▼" button twice to switch to "export data log" function and it will show "LOG" in the LCD. Press "←" button to confirm the selection for export data log.	
	If the selected function is ready, LCD will display "LOG". Press "←" button to confirm the selection again.	
	<ul style="list-style-type: none"> ● Press "▲" button to select "Yes" to export data log. "YES" will disappear after this action is complete. Then, press "↻" button to return to main screen. ● Or press "▼" button to select "No" to return to main screen. 	 

If no button is pressed for 1 minute, it will automatically return to main screen.

Error message:



Error Code	Messages
U01	No USB disk is detected.
U02	USB disk is protected from copy.
U03	Document inside the USB disk with wrong format.

If any error occurs, error code will only show 3 seconds. After 3 seconds, it will automatically return to display screen.

LCD Display

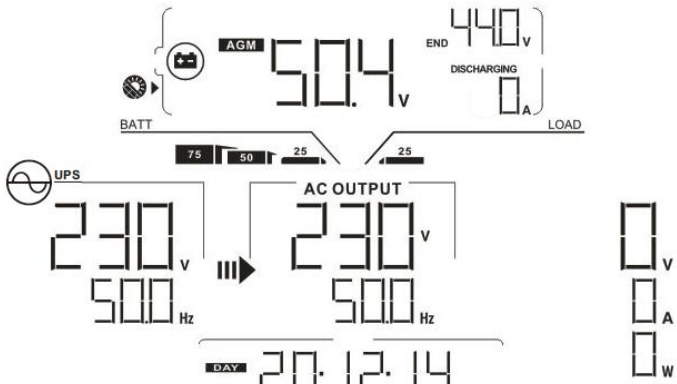
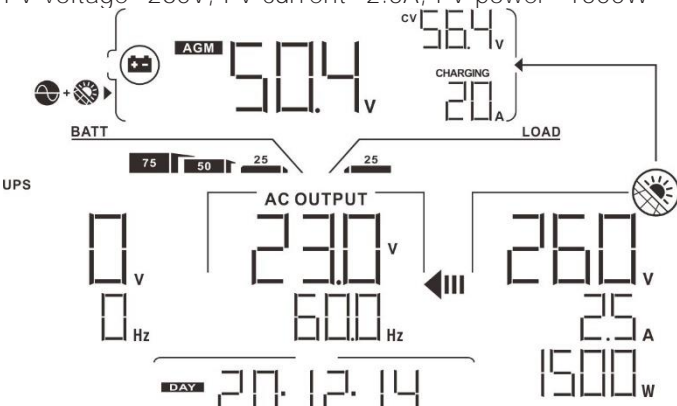
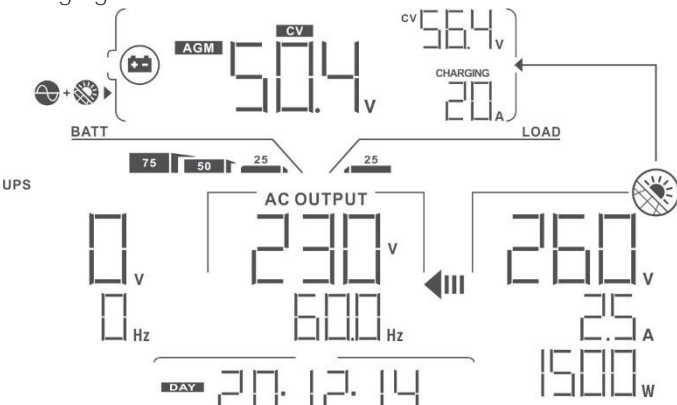
The LCD display information will be switched in turn by pressing the "▲" or "▼" button. The selectable information is switched as the following table in order.

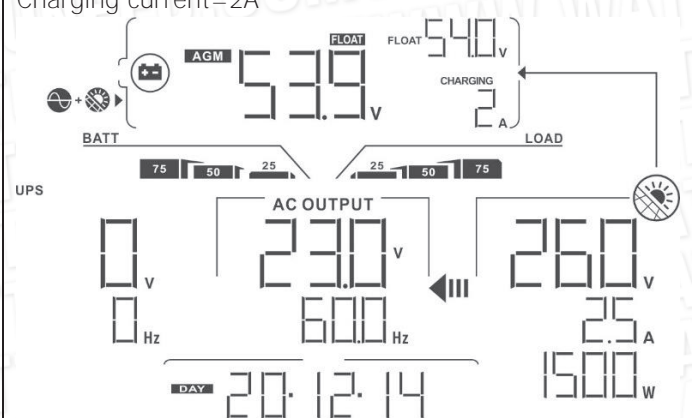
Selectable information	LCD display
Utility voltage/ Utility frequency	<p>Input Voltage=230V, Input frequency=50Hz</p> 
PV voltage/ PV current/ PV power	<p>PV voltage=260V, PV current=2.5A, PV power=1500W</p> 
Battery voltage, charging stage/ Configured battery parameters/ Charging or discharging current	<p>Battery voltage=50.4V, Bulk charging voltage=56.4V, Charging current=20A</p> 

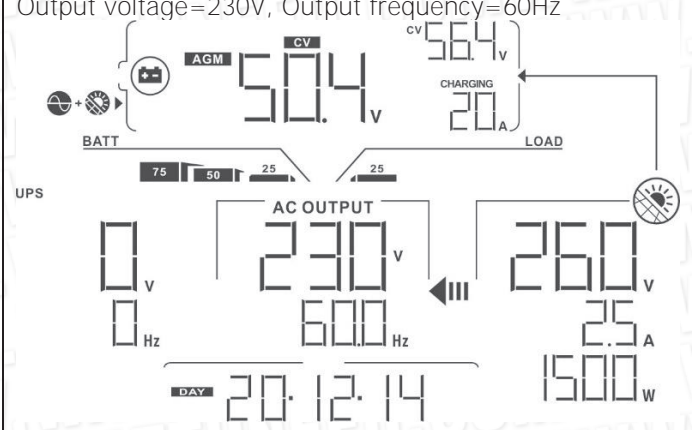
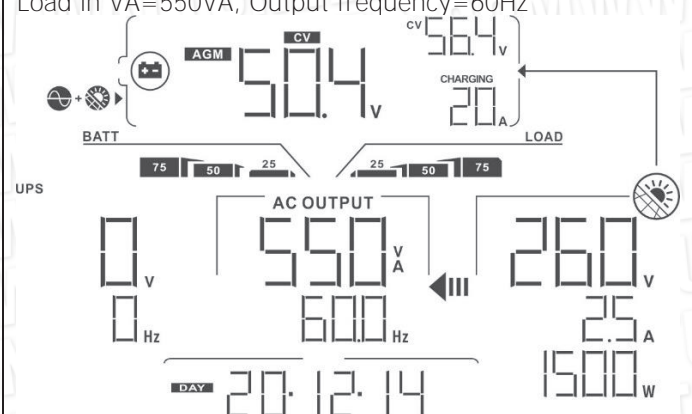
<p>Default Display Screen</p>	<p>Battery voltage, charging stage/ Configured battery parameters/ Charging or discharging current</p>	<p>Battery voltage=53.9V, Floating charging voltage=54.0V, Charging current=2A</p> 
		<p>Battery voltage=50.4V, Low DC cut-off voltage=44.0V, Discharging current=20A</p> 
<p>Output voltage, load in VA, load in Watt switch every 5 second/ Output frequency</p>		<p>Output voltage=230V, Output frequency=60Hz</p> 
<p>Output voltage, load in VA, load in Watt switch every 5 second/ Output frequency</p>		<p>Load in VA=550VA, Output frequency=60Hz</p> 

<p>Default Display Screen</p>	<p>Output voltage, load in VA, load in Watt switch every 5 second/ Output frequency</p>	<p>Load in Watt=600W, Output frequency=60Hz</p>
<p>Real date</p>	<p>Real date.</p>	<p>Real date Dec 14, 2020.</p>
<p>Real time.</p>	<p>Real time.</p>	<p>Real time 11:31.</p>
<p>PV energy generation today</p>	<p>PV energy generation today</p>	<p>PV energy generation today = 0Wh.</p>

PV energy generation this month

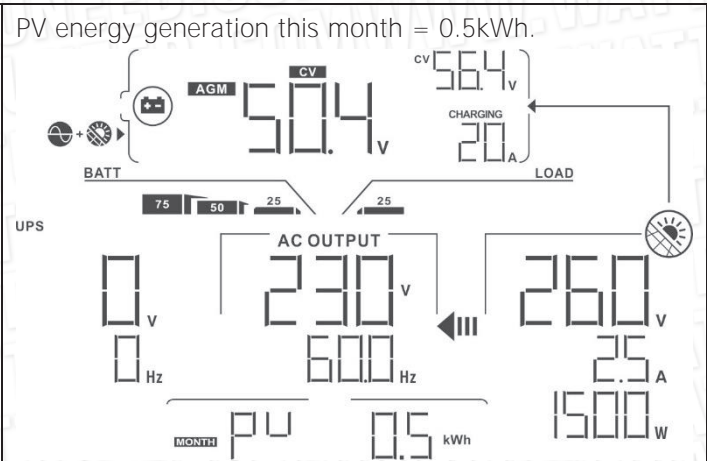

PV energy generation this year

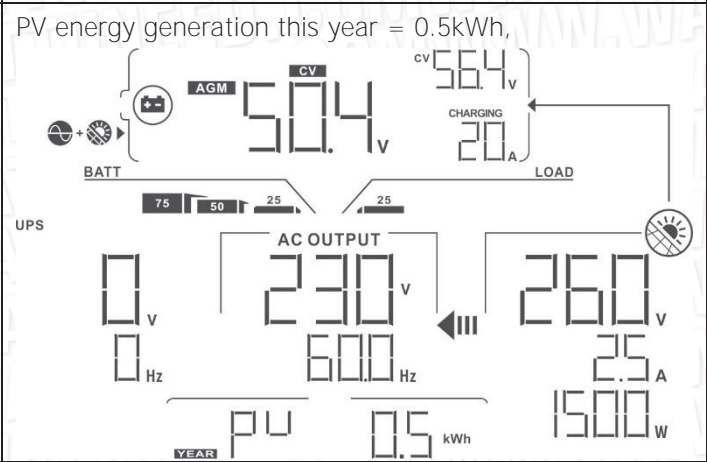

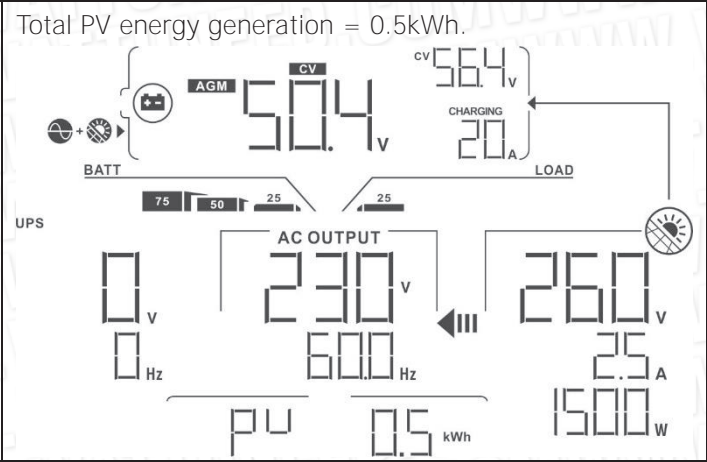

Total PV energy generation

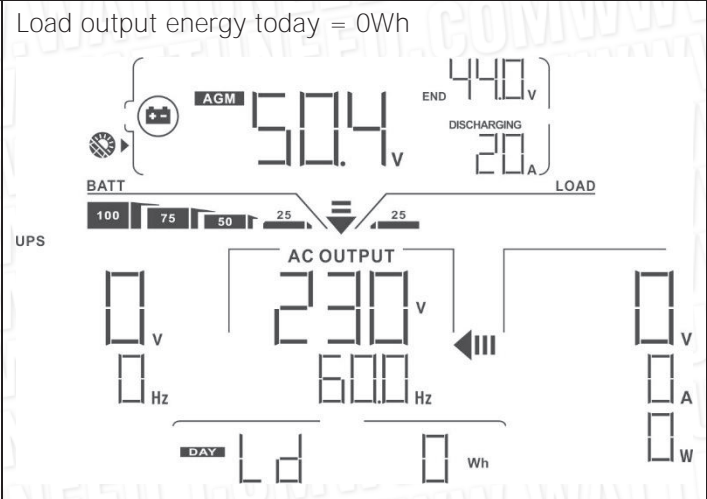

Load output energy today

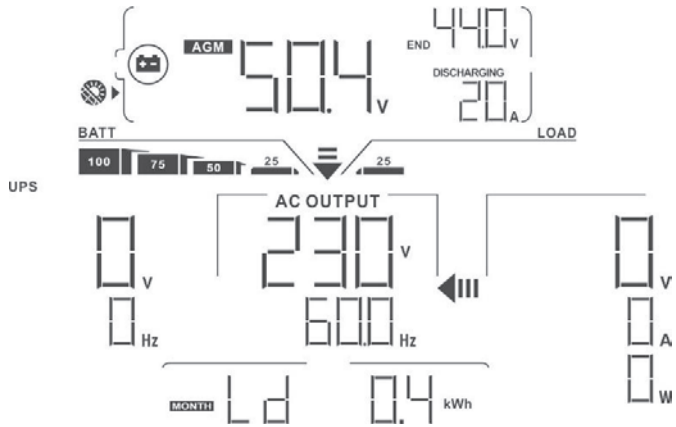
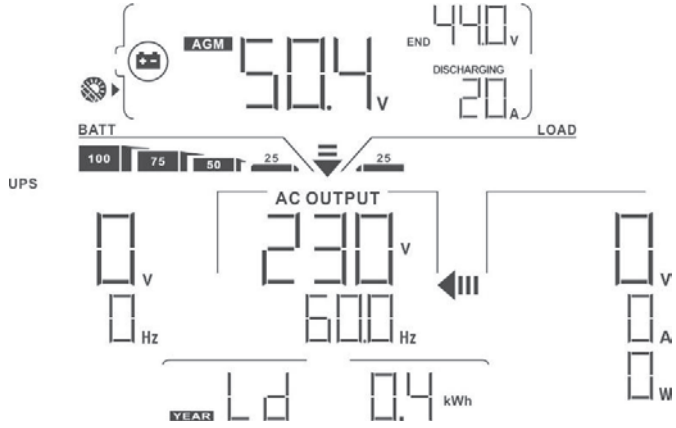

<p>Load output energy this month</p>	<p>Load output energy this month = 0.4kWh</p> 
<p>Load output energy this year</p>	<p>Load output energy this year = 0.4kWh</p> 
<p>Load output total energy.</p>	<p>Load Output Total energy = 0.4kWh.</p> 
<p>Main CPU version checking.</p>	<p>Main CPU version 00050.72.</p> 

Secondary CPU version checking.

Secondary CPU version 00022.01.



Wi-Fi version checking.

Wi-Fi version 00088.88.



Operating Mode Description

Operation mode	Description	LCD display
<p>Standby mode</p> <p>Note:</p> <p>*Standby mode: The inverter is not turned on yet but at this time, the inverter can charge battery without AC output.</p>	<p>No output is supplied by the unit but it still can charge batteries.</p>	<p>Charging by utility and PV energy.</p>
		<p>Charging by utility.</p>
		<p>Charging by PV energy.</p>
		<p>No charging.</p>

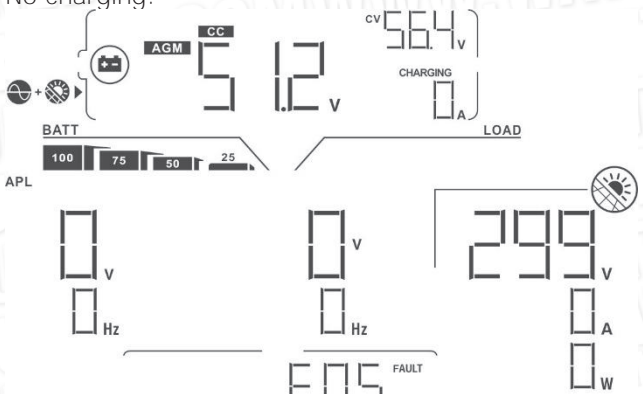
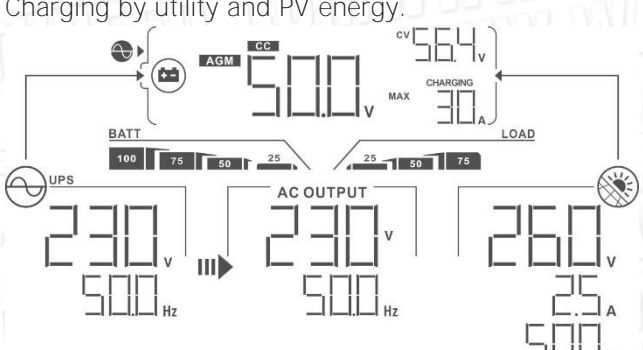
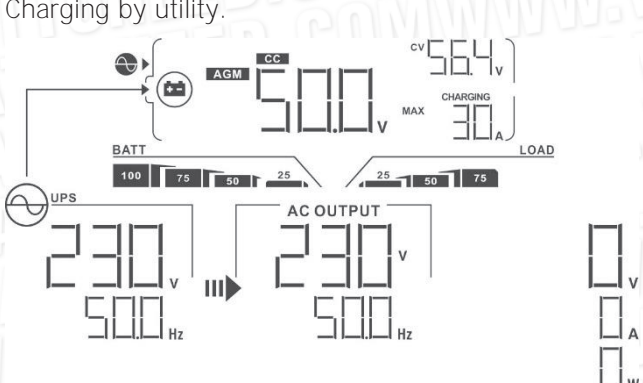
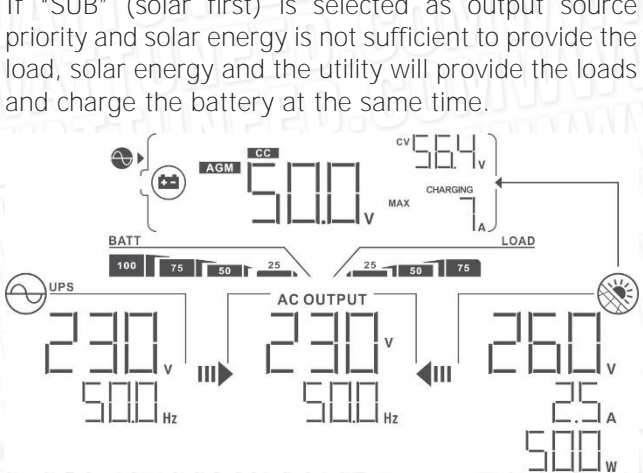
Operation mode	Description	LCD display
<p>Fault mode</p> <p>Note:</p> <p>*Fault mode: Errors are caused by inside circuit error or external reasons such as over temperature, output short circuited and so on.</p>	<p>No output is supplied by the unit.</p>	<p>No charging.</p> 
<p>Line Mode</p>	<p>The unit will provide output power from the mains. It will also charge the battery at line mode.</p>	<p>Charging by utility and PV energy.</p> 
	<p>Charging by utility.</p> 	
	<p>If "SUB" (solar first) is selected as output source priority and solar energy is not sufficient to provide the load, solar energy and the utility will provide the loads and charge the battery at the same time.</p> 	

Operation mode	Description	LCD display
Line Mode	The unit will provide output power from the mains. It will also charge the battery at line mode.	<p>If either "SUB" (solar first) or "SBU" is selected as output source priority and battery is not connected, solar energy and the utility will provide the loads.</p>
		<p>Power from utility</p>
Battery Mode	The unit will provide output power from battery and/or PV power.	<p>Power from battery and PV energy.</p>
		<p>PV energy will supply power to the loads and charge battery at the same time. No utility is available.</p>

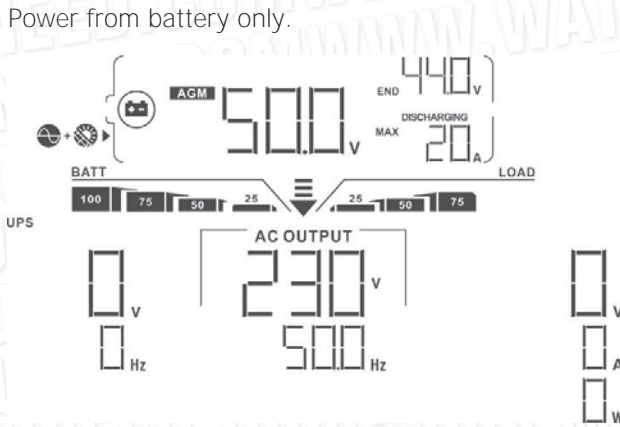
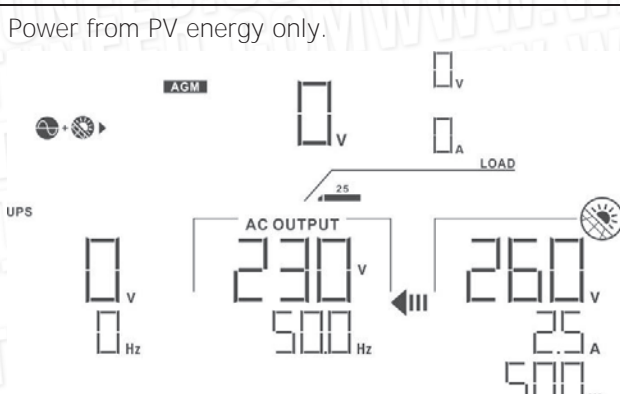









Operation mode	Description	LCD display
Battery Mode	The unit will provide output power from battery and/or PV power.	Power from battery only. 
		Power from PV energy only. 

Faults Reference Code

Fault Code	Fault Event	Icon on
01	Fan is locked when inverter is off.	F01
02	Over temperature	F02
03	Battery voltage is too high	F03
05	Output short circuited.	F05
06	Output voltage is too high.	F06
07	Overload time out	F07
08	Bus voltage is too high	F08
09	Bus soft start failed	F09
10	PV over current	F10
11	PV over voltage	F11
12	DCDC over current	F12
51	Over current	F51
52	Bus voltage is too low	F52

53	Inverter soft start failed	F53
55	Over DC voltage in AC output	F55
57	Current sensor failed	F57
58	Output voltage is too low	F58

Warning Indicator

Warning Code	Warning Event	Audible Alarm	Icon flashing
01	Fan is locked when inverter is on.	Beep three times every second	01 
02	Over temperature	None	02 
03	Battery is over-charged	Beep once every second	03 
04	Low battery	Beep once every second	04 
07	Overload	Beep once every 0.5 second	07  
10	Output power is derated	Beep twice every 3 seconds	10 
32	Communication failure between inverter and display panel	None	32 
E9	Battery equalization	None	E9 
bP	Battery is not connected	None	bP 

BATTERY EQUALIZATION

Equalization function is added into charge controller. It reverses the buildup of negative chemical effects like stratification, a condition where acid concentration is greater at the bottom of the battery than at the top. Equalization also helps to remove sulfate crystals that might have built up on the plates. If left unchecked, this condition, called sulfation, will reduce the overall capacity of the battery. Therefore, it's recommended to equalize battery periodically.

- How to Apply Equalization Function

You must enable battery equalization function in monitoring LCD setting program 33 first. Then, you may apply this function in device by either one of following methods:

1. Setting equalization interval in program 37.
2. Active equalization immediately in program 39.

- When to Equalize

In float stage, when the setting equalization interval (battery equalization cycle) is arrived, or equalization is active immediately, the controller will start to enter Equalize stage.

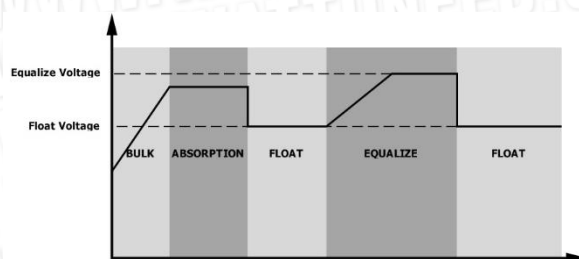

- Equalize charging time and timeout

In Equalize stage, the controller will supply power to charge battery as much as possible until battery voltage raises to battery equalization voltage. Then, constant-voltage regulation is applied to maintain battery voltage at the battery equalization voltage. The battery will remain in the Equalize stage until setting battery equalized time is arrived.

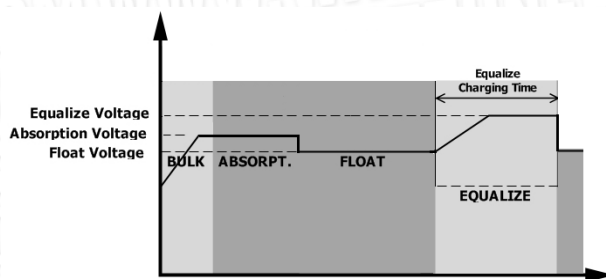

However, in Equalize stage, when battery equalized time is expired and battery voltage doesn't rise to battery equalization voltage point, the charge controller will extend the battery equalized time until battery voltage achieves battery equalization voltage. If battery voltage is still lower than battery equalization voltage when battery equalized timeout setting is over, the charge controller will stop equalization and return to float stage.

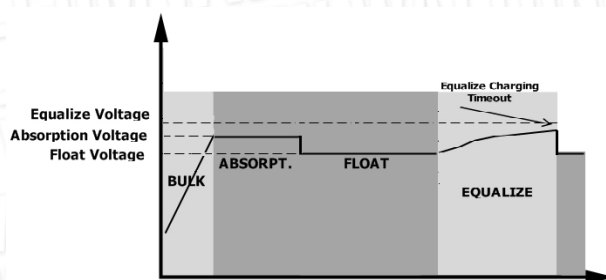

SPECIFICATIONS

Table 1 Line Mode Specifications

INVERTER MODEL	3.6KW	5.6KW
Input Voltage Waveform	Sinusoidal (utility or generator)	
Nominal Input Voltage	230Vac	
Low Loss Voltage	170Vac±7V (UPS) 90Vac±7V (Appliances)	
Low Loss Return Voltage	180Vac±7V (UPS); 100Vac±7V (Appliances)	
High Loss Voltage	280Vac±7V	
High Loss Return Voltage	270Vac±7V	
Max AC Input Voltage	300Vac	
Nominal Input Frequency	50Hz / 60Hz (Auto detection)	
Low Loss Frequency	40±1Hz	
Low Loss Return Frequency	42±1Hz	
High Loss Frequency	65±1Hz	
High Loss Return Frequency	63±1Hz	
Output Short Circuit Protection	Line mode: Circuit Breaker Battery mode: Electronic Circuits	
Efficiency (Line Mode)	>95% (Rated R load, battery full charged)	
Transfer Time	10ms typical (UPS); 20ms typical (Appliances)	
Output power derating: When AC input voltage drops to 95V or 170V depending on models, the output power will be derated.	 <p>The graph plots Output Power on the y-axis against Input Voltage on the x-axis. The x-axis has markers at 90V, 170V, and 280V. The y-axis has markers for 50% Power and Rated Power. The power curve starts at a low level, jumps to 50% power at 90V, then rises linearly to the Rated Power level at 170V. It remains constant at Rated Power until 280V, where it drops to zero.</p>	

Table 2 Inverter Mode Specifications

INVERTER MODEL	3.6KW	5.6KW
Rated Output Power	3.6KVA/3.6KW	5.6KVA/5.6KW
Output Voltage Waveform	Pure Sine Wave	
Output Voltage Regulation	230Vac±5%	
Output Frequency	60Hz or 50Hz	
Peak Efficiency	90%	
Overload Protection	5s@≥150% load; 10s@110%~150% load	
Surge Capacity	2* rated power for 5 seconds	
Nominal DC Input Voltage	48Vdc	
Cold Start Voltage	46.0Vdc	
Low DC Warning Voltage @ load < 20% @ 20% ≤ load < 50% @ load ≥ 50%	44.0Vdc 42.8Vdc 40.4Vdc	
Low DC Warning Return Voltage @ load < 20% @ 20% ≤ load < 50% @ load ≥ 50%	46.0Vdc 44.8Vdc 42.4Vdc	
Low DC Cut-off Voltage @ load < 20% @ 20% ≤ load < 50% @ load ≥ 50%	42.0Vdc 40.8Vdc 38.4Vdc	
High DC Recovery Voltage	64Vdc	
High DC Cut-off Voltage	66Vdc	

Table 3 Charge Mode Specifications

Utility Charging Mode		
INVERTER MODEL	3.6KW	5.6KW
Charging Current (UPS) @ Nominal Input Voltage	100A	120A
Bulk Charging Voltage	Flooded Battery	58.4
	AGM / Gel Battery	56.4
Floating Charging Voltage	54Vdc	
Overcharge Protection	66Vdc	
Charging Algorithm	3-Step	
Charging Curve		
Solar Charging Mode (MPPT type)		
INVERTER MODEL	3.6KW	5.6KW
Rated Power	5000W	6000W
Max. Charging Current	100A	120A
Max. PV Array Open Circuit Voltage	500Vdc	450Vdc
PV Array MPPT Voltage Range	120Vdc~430Vdc	
Max. Input Current	18A	27A

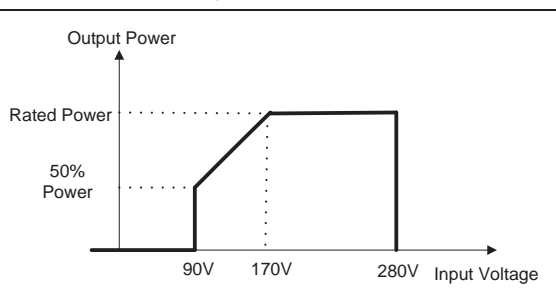
Table 4 General Specifications

INVERTER MODEL	3.6KW	5.6KW
Safety Certification	CE	
Operating Temperature Range	-10°C to 50°C	
Storage temperature	-15°C~ 60°C	
Humidity	5% to 95% Relative Humidity (Non-condensing)	
Dimension (D*W*H), mm	140 x 295 x 468	
Net Weight, kg	11	12

TROUBLE SHOOTING

Problem	LCD/LED/Buzzer	Explanation / Possible cause	What to do
Unit shuts down automatically during startup process.	LCD/LEDs and buzzer will be active for 3 seconds and then complete off.	The battery voltage is too low (<1.91V/Cell)	1. Re-charge battery. 2. Replace battery.
No response after power on.	No indication.	1. The battery voltage is far too low. (<1.4V/Cell) 2. Battery polarity is connected reversed.	1. Check if batteries and the wiring are connected well. 2. Re-charge battery. 3. Replace battery.
Mains exist but the unit works in battery mode.	Input voltage is displayed as 0 on the LCD and green LED is flashing.	Input protector is tripped	Check if AC breaker is tripped and AC wiring is connected well.
	Green LED is flashing.	Insufficient quality of AC power. (Shore or Generator)	1. Check if AC wires are too thin and/or too long. 2. Check if generator (if applied) is working well or if input voltage range setting is correct. (UPS→Appliance)
	Green LED is flashing.	Set "Solar First" as the priority of output source.	Change output source priority to Utility first.
When the unit is turned on, internal relay is switched on and off repeatedly.	LCD display and LEDs are flashing	Battery is disconnected.	Check if battery wires are connected well.
Buzzer beeps continuously and red LED is on.	Fault code 07	Overload error. The inverter is overload 110% and time is up.	Reduce the connected load by switching off some equipment.
	Fault code 05	Output short circuited.	Check if wiring is connected well and remove abnormal load.
	Fault code 02	Internal temperature of inverter component is over 100°C.	Check whether the air flow of the unit is blocked or whether the ambient temperature is too high.
	Fault code 03	Battery is over-charged.	Return to repair center.
		The battery voltage is too high.	Check if spec and quantity of batteries are meet requirements.
	Fault code 01	Fan fault	Replace the fan.
	Fault code 06/58	Output abnormal (Inverter voltage below than 190Vac or is higher than 260Vac)	1. Reduce the connected load. 2. Return to repair center
	Fault code 08/09/53/57	Internal components failed.	Return to repair center.
	Fault code 51	Over current or surge.	Restart the unit, if the error happens again, please return to repair center.
	Fault code 52	Bus voltage is too low.	
	Fault code 55	Output voltage is unbalanced.	
Fault code 56	Battery is not connected well or fuse is burnt.	If the battery is connected well, please return to repair center.	

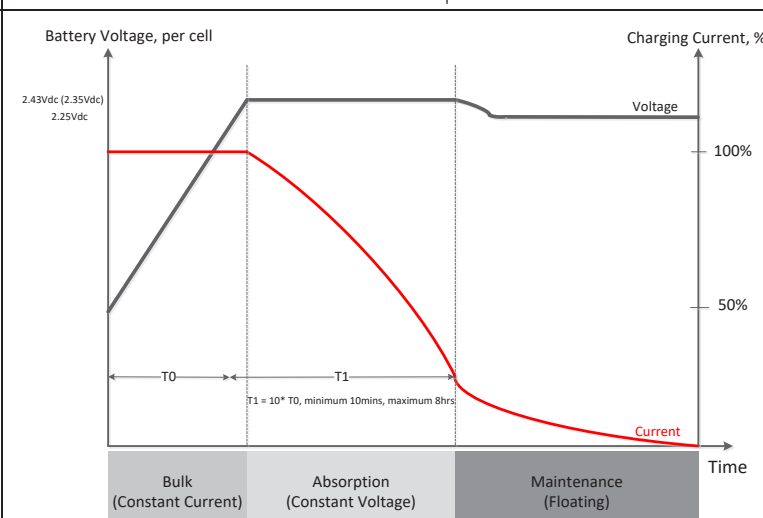
Appendix I: Parallel function

1. Introduction

This inverter can be used in parallel with two different operation modes.

1. Parallel operation in single phase is with up to 9 units. The supported maximum output power for 3.6KW is 32.4KW/32.4KVA. The supported maximum output power for 5.6KW is 50.4KW/50.4KVA.
2. Maximum 9 units work together to support three-phase equipment. Maximum seven units support one phase.

WARNING: Please make sure all output N wires of each inverter should be connected always. Otherwise, it will cause fault in error #72.

2. Package Contents

In parallel kit, you will find the following items in the package:

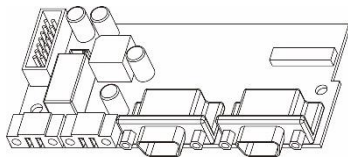

Parallel board



Parallel communication cable



Current sharing cable

3. Parallel board installation

Step 1: Remove wire cover by unscrewing all screws.

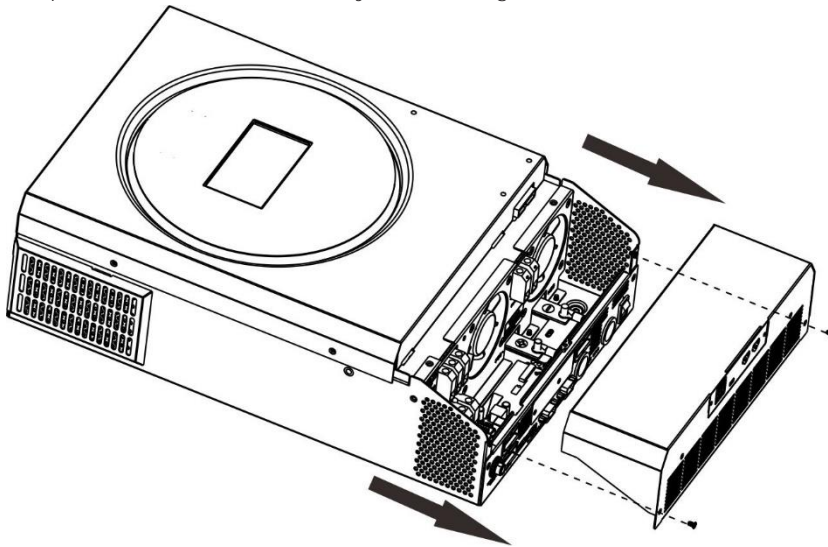

Step 2: Remove two screws as below chart and remove 2-pin and 14-pin cables. Take out the board under the communication board.

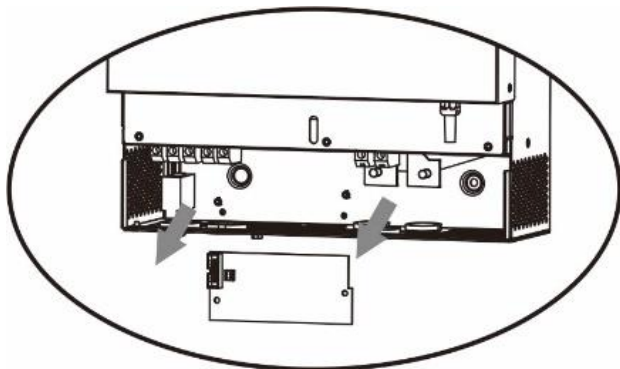

Step 3: Remove two screws as below chart to take out cover of parallel communication.

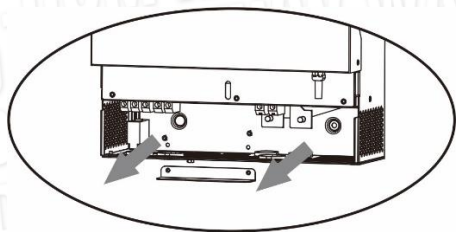

Step 4: Install new parallel board with 2 screws tightly.

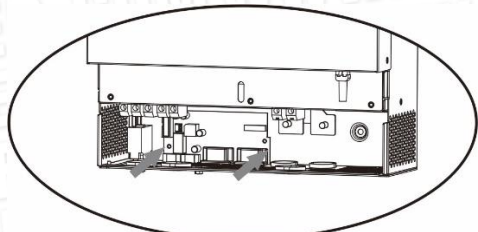

Step 6: Connect 2-pin to original position.

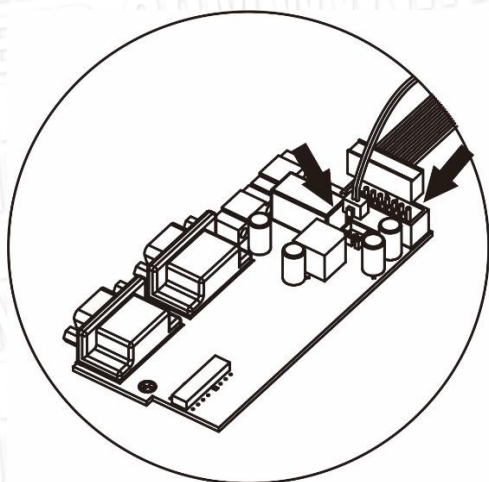

Step 7: Put communication board back to the unit.

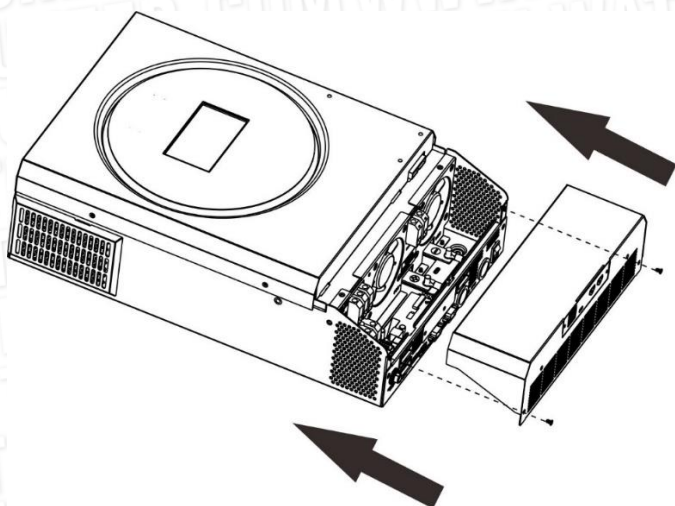

Step 8: Put wire cover back to the unit. Now the inverter is providing parallel operation function.

4. Mounting the Unit

When installing multiple units, please follow below chart.

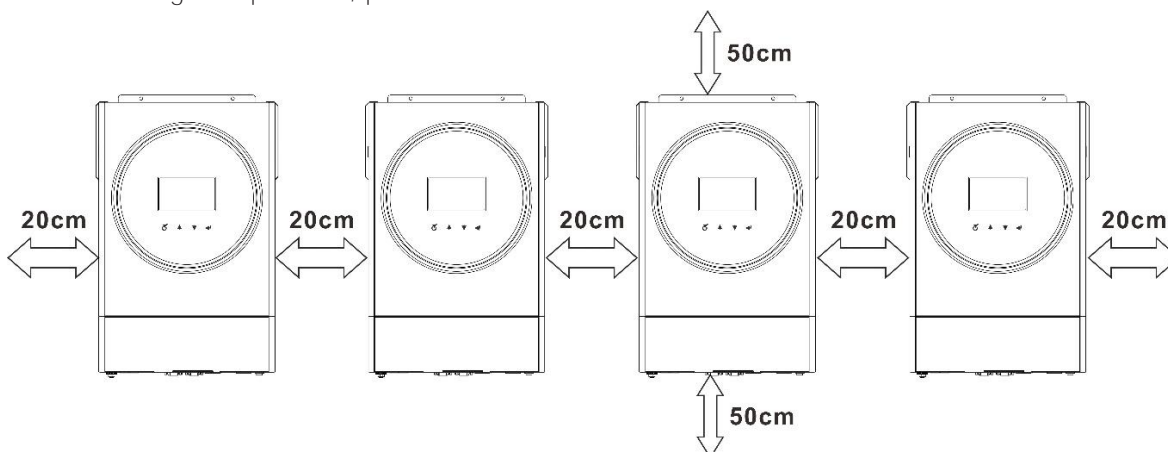

NOTE: For proper air circulation to dissipate heat, allow a clearance of approx. 20 cm to the side and approx. 50 cm above and below the unit. Be sure to install each unit in the same level.

5. Wiring Connection

NOTICE: It's required to connect to battery for parallel operation.

The cable size of each inverter is shown as below:

Recommended battery cable and terminal size for each inverter:

Model	Wire Size	Ring Terminal		Torque value	
		Cable mm ²	Dimensions		
			D (mm)	L (mm)	
3.6KW	1*4AWG	22	6.4	33.5	2~3
5.6KW	1*2AWG or 2*6AWG	28	6.4	42.7	2~3

Ring terminal:

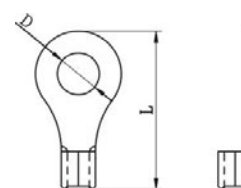

WARNING: Be sure the length of all battery cables is the same. Otherwise, there will be voltage difference between inverter and battery to cause parallel inverters not working.

Recommended AC input and output cable size for each inverter:

Model	AWG no.	Torque
3.6KW	12 AWG	1.2~ 1.6Nm
5.6KW	10 AWG	1.2~ 1.6Nm

You need to connect the cables of each inverter together. Take the battery cables for example: You need to use a connector or bus-bar as a joint to connect the battery cables together, and then connect to the battery terminal. The cable size used from joint to battery should be X times cable size in the tables above. "X" indicates the number of inverters connected in parallel.

Regarding AC input and output, please also follow the same principle.

CAUTION!! Please install the breaker at the battery and AC input side. This will ensure the inverter can be securely disconnected during maintenance and fully protected from over current of battery or AC input. The recommended mounted location of the breakers is shown in the figures in 5-1 and 5-2.

Recommended breaker specification of battery for each inverter:

Model	1 unit*
3.6KW	100A/70VDC
5.6KW	140A/70VDC

*If you want to use only one breaker at the battery side for the whole system, the rating of the breaker

should be X times current of 1 unit. "X" indicates the number of inverters connected in parallel.

Recommended breaker specification of AC input with single phase:

Model	2 units	3 units	4 units	5 units	6 units	7 units	8 units	9 units
3.6KW	80A/ 230VAC	120A/ 230VAC	160A/ 230VAC	200A/ 230VAC	240A/ 230VAC	280A/ 230VAC	320A/ 230VAC	360A/ 230VAC
5.6KW	80A/ 230VAC	120A/ 230VAC	160A/ 230VAC	200A/ 230VAC	240A/ 230VAC	280A/ 230VAC	320A/ 230VAC	360A/ 230VAC

Note1: Also, you can use 50A breaker for only 1 unit and install one breaker at its AC input in each inverter.

Note2: Regarding three-phase system, you can use 4-pole breaker directly and the rating of the breaker should be compatible with the phase current limitation from the phase with maximum units

Recommended battery capacity

Inverter parallel numbers	2	3	4	5	6	7	8	9
Battery Capacity	200AH	400AH	400AH	600AH	600AH	800AH	800AH	1000AH

WARNING! Be sure that all inverters will share the same battery bank. Otherwise, the inverters will transfer to fault mode.

5-1. Parallel Operation in Single phase

Two inverters in parallel:

Power Connection

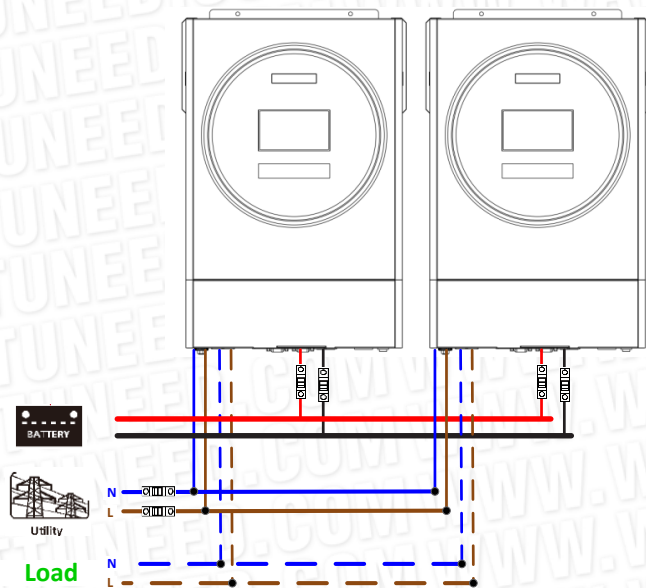

Communication Connection

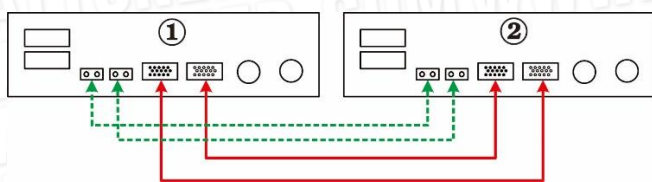

Three inverters in parallel:

Power Connection

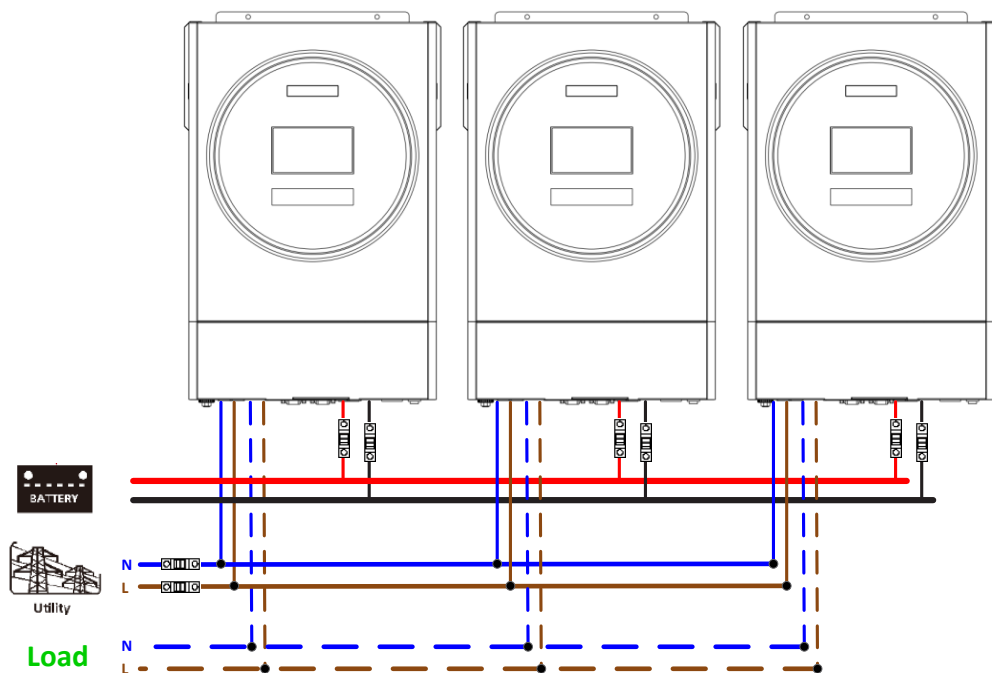

Communication Connection

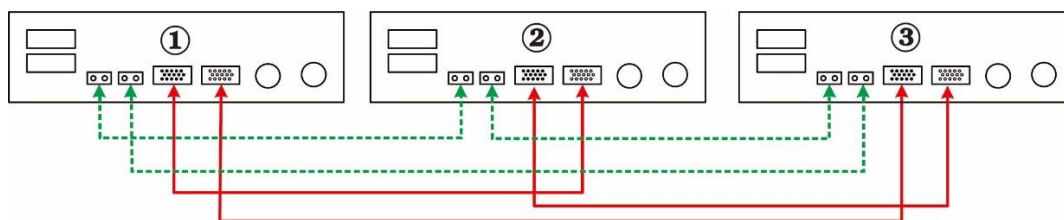

Four inverters in parallel:

Power Connection

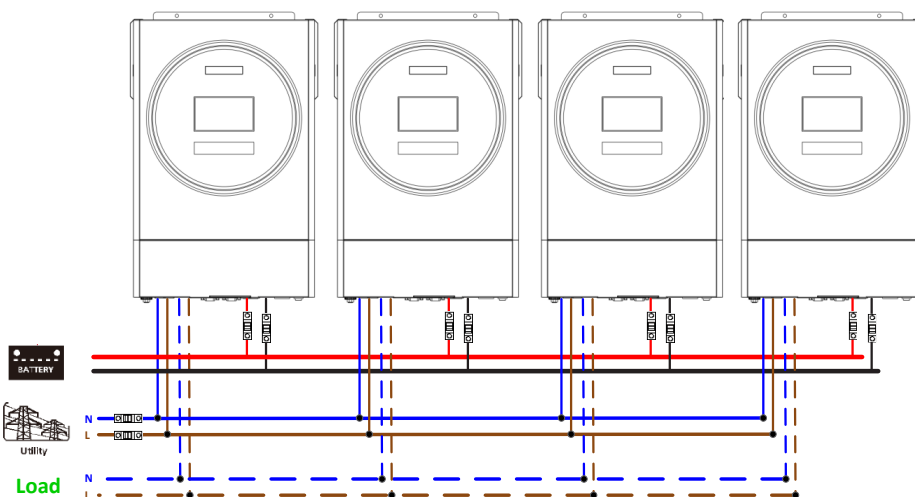

Communication Connection

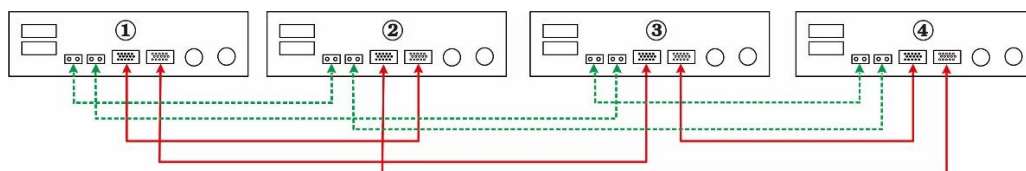

Five inverters in parallel:

Power Connection

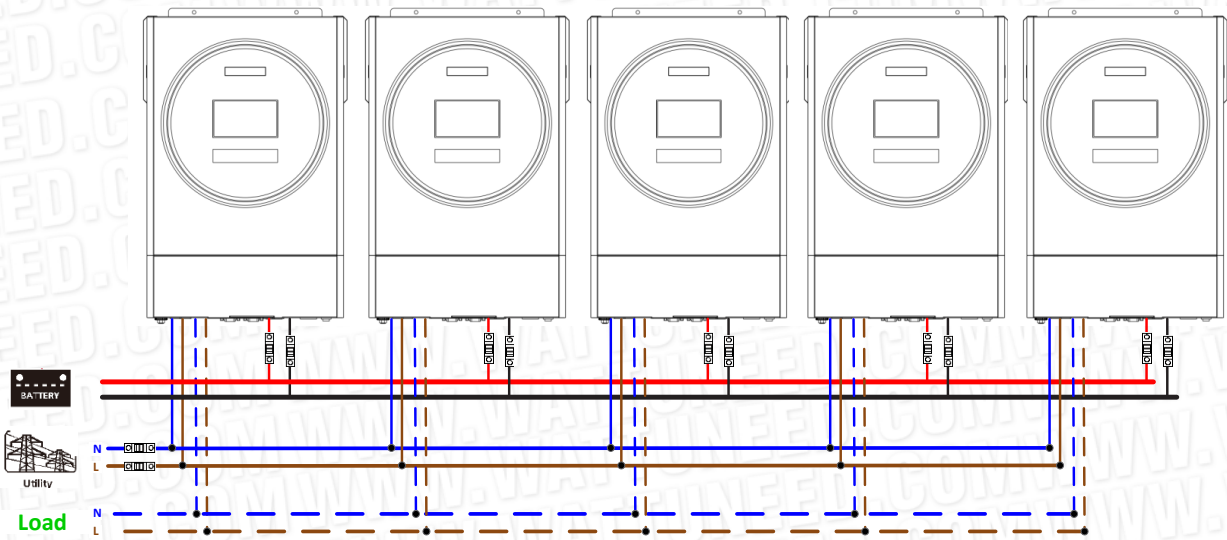

Communication Connection

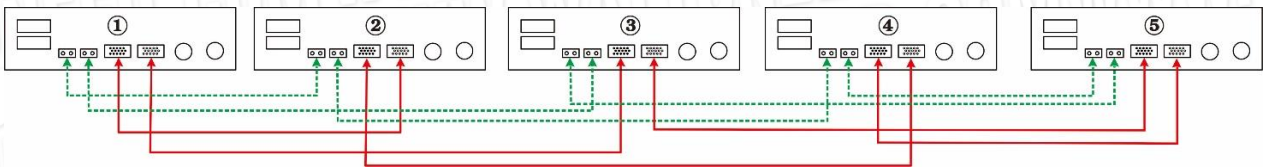

Six inverters in parallel:

Power Connection

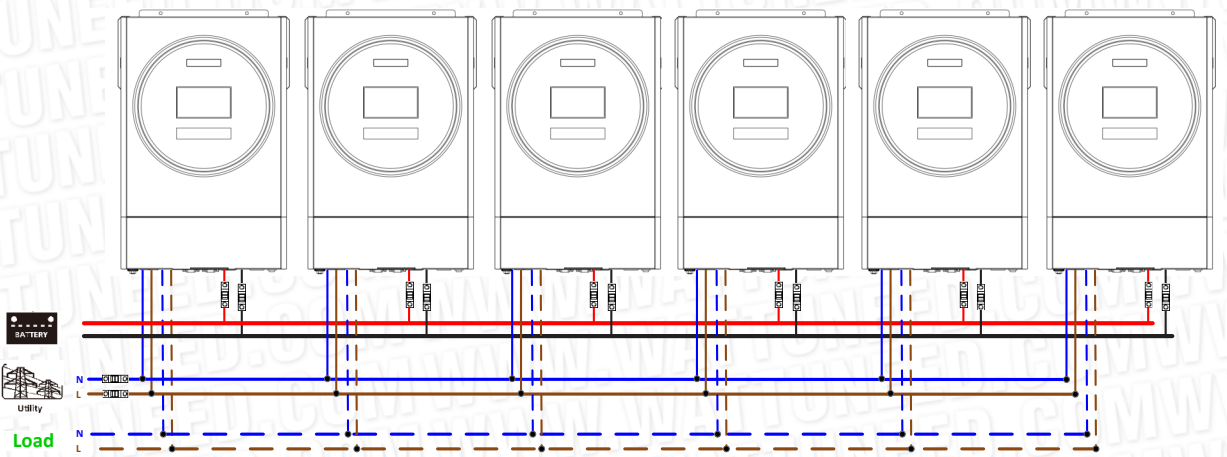

Communication Connection

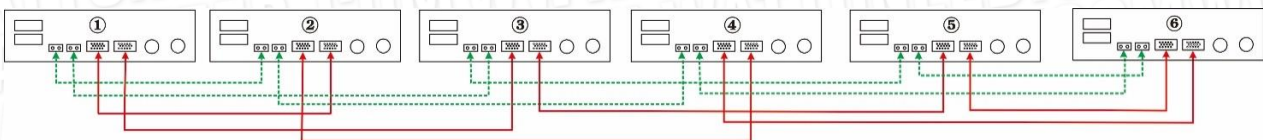

Seven inverters in parallel:

Power Connection

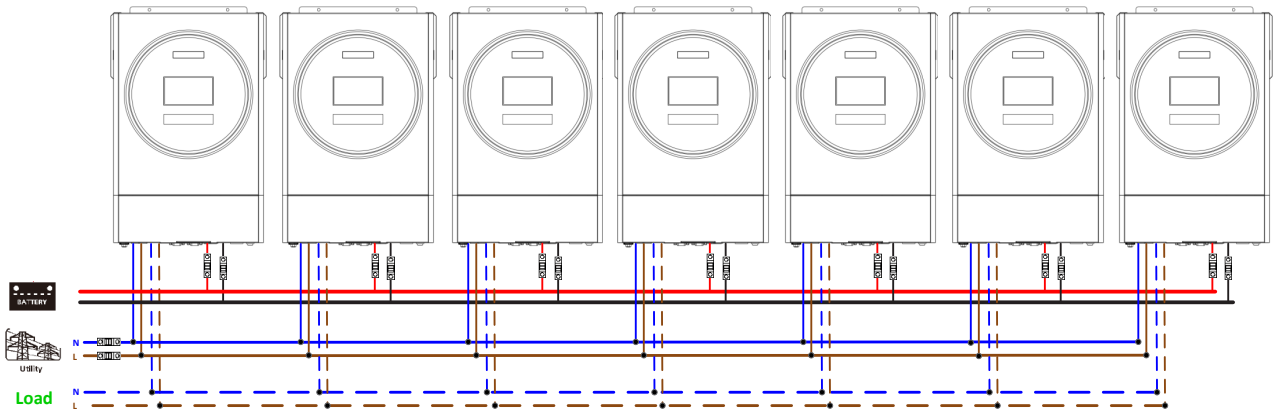

Communication Connection

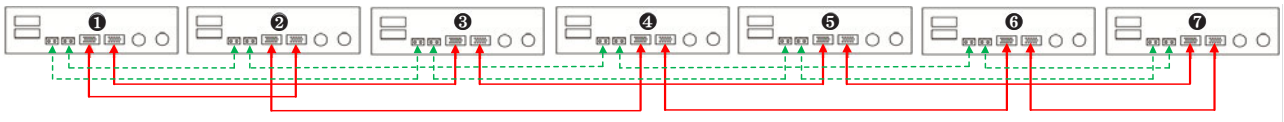

Eight inverters in parallel:

Power Connection

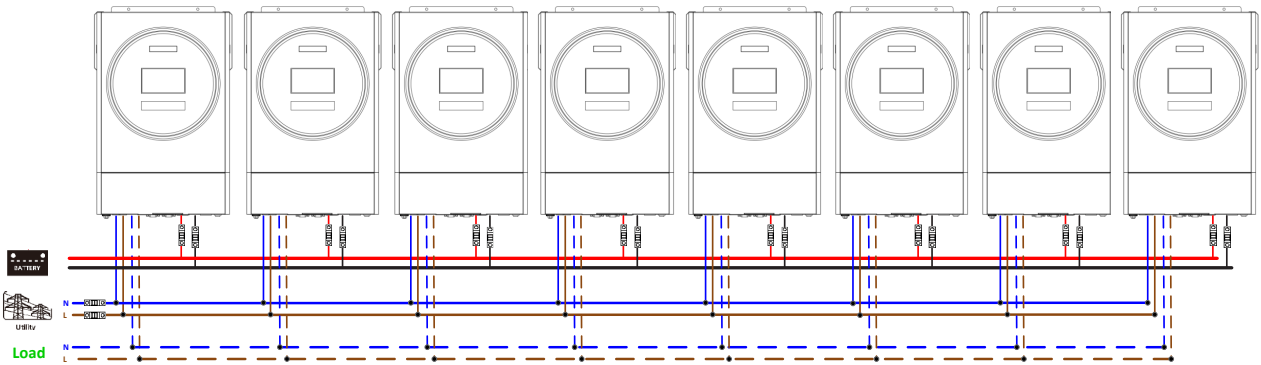

Communication Connection

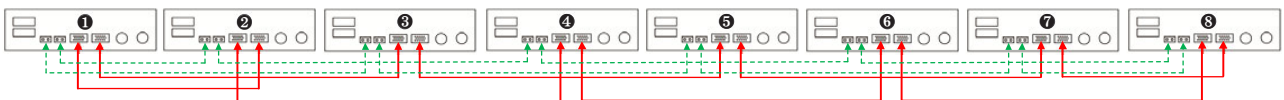

Nine inverters in parallel:

Power Connection

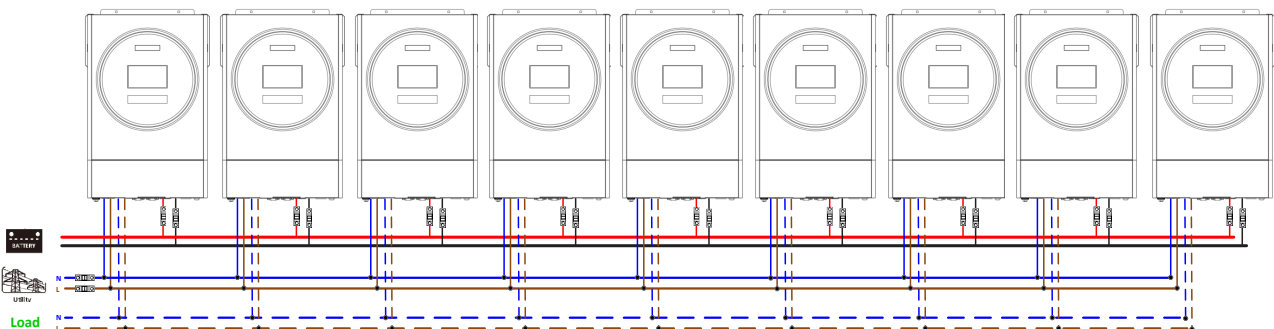

Communication Connection

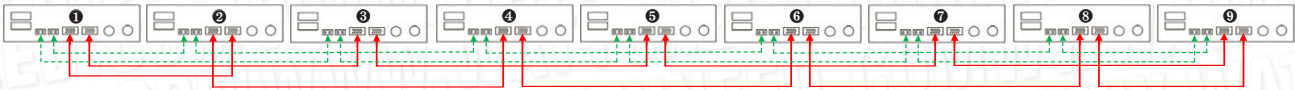

5-2. Support 3-phase equipment

Three inverters in each phase:

Power Connection

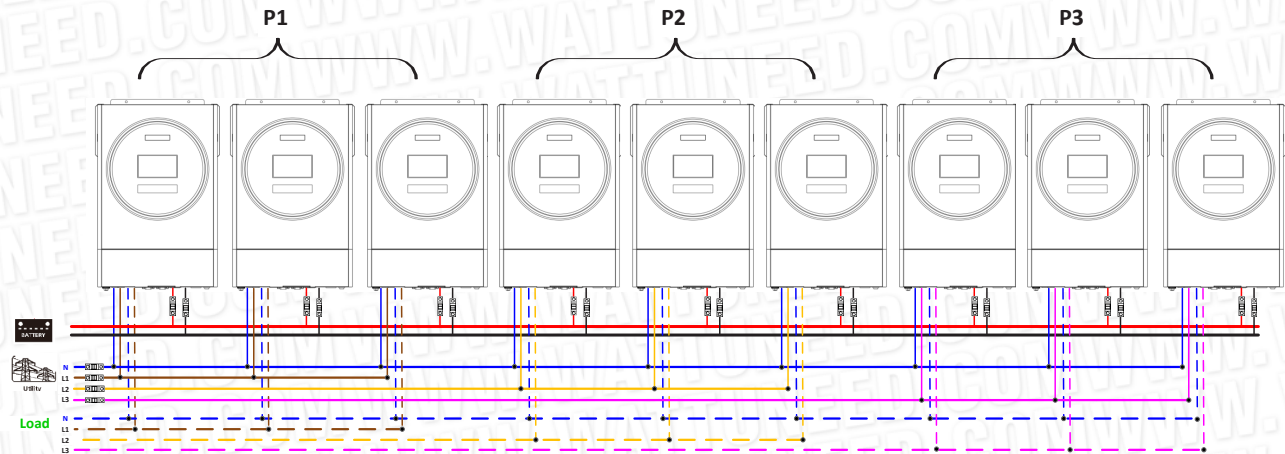

Communication Connection

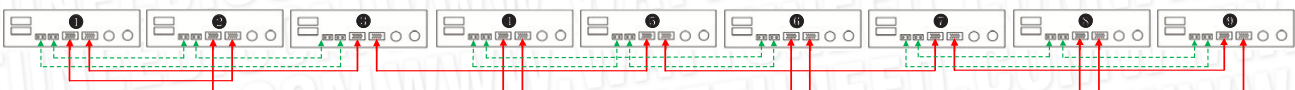

Three inverters in one phase, three inverters in second phase and two inverter for the third phase:

Power Connection

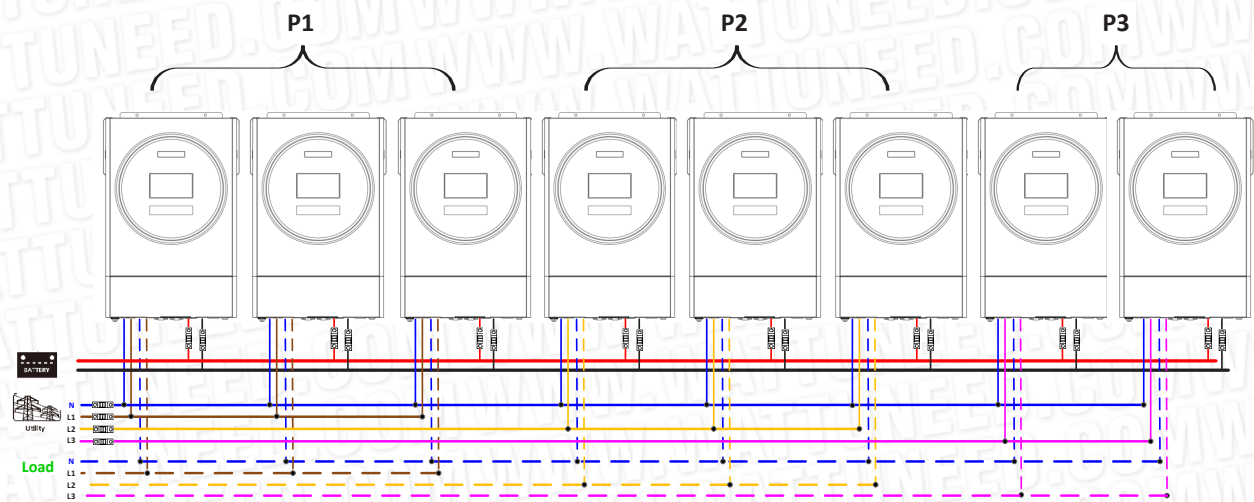

Communication Connection

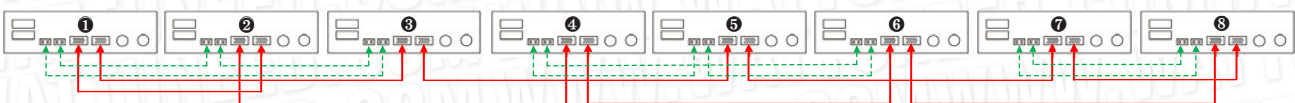

Three inverters in one phase, two inverters in second phase and two inverters for the third phase:

Power Connection

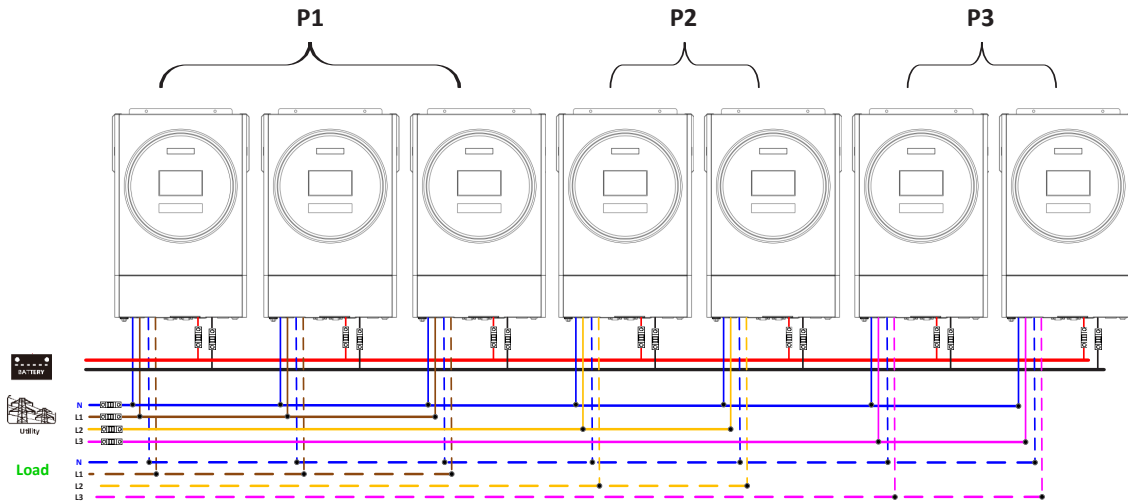

Communication Connection

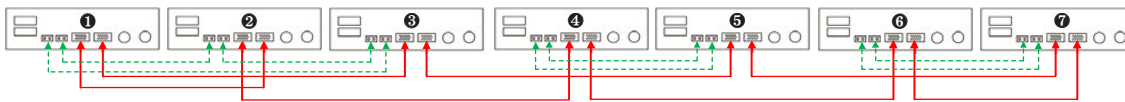

Two inverters in each phase:

Power Connection

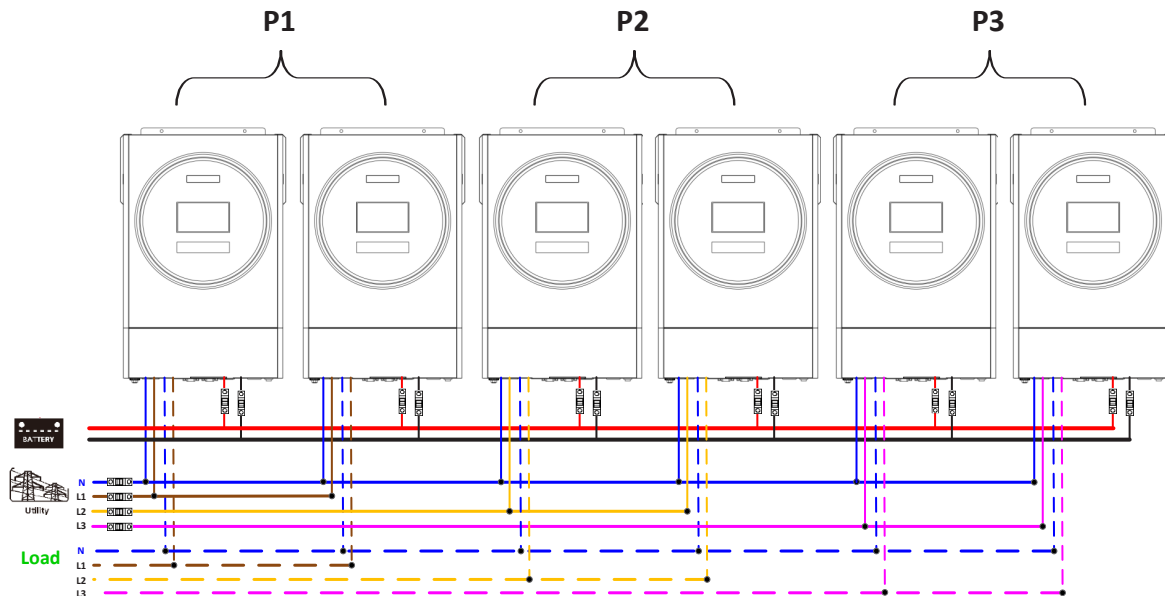

Communication Connection

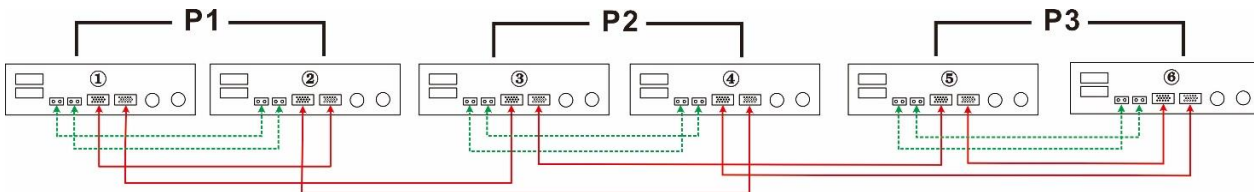

Seven inverters in one phase and one inverter for the other two phases:

Power Connection

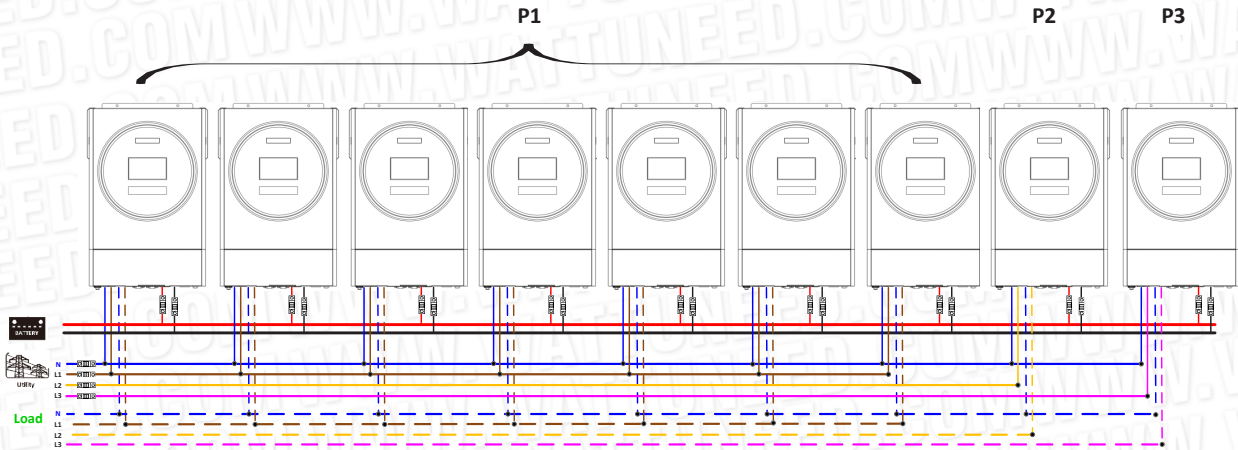

Note: It's up to customer's demand to pick 7 inverters on any phase.

P1: L1-phase, P2: L2-phase, P3: L3-phase.

Communication Connection

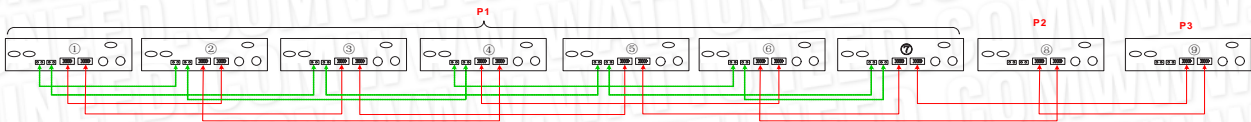

Note: If there is only one unit in one phase, this unit doesn't need to connect the current sharing cable.

Or you connect it like as below:

Four inverters in one phase and one inverter for the other two phases:

Power Connection

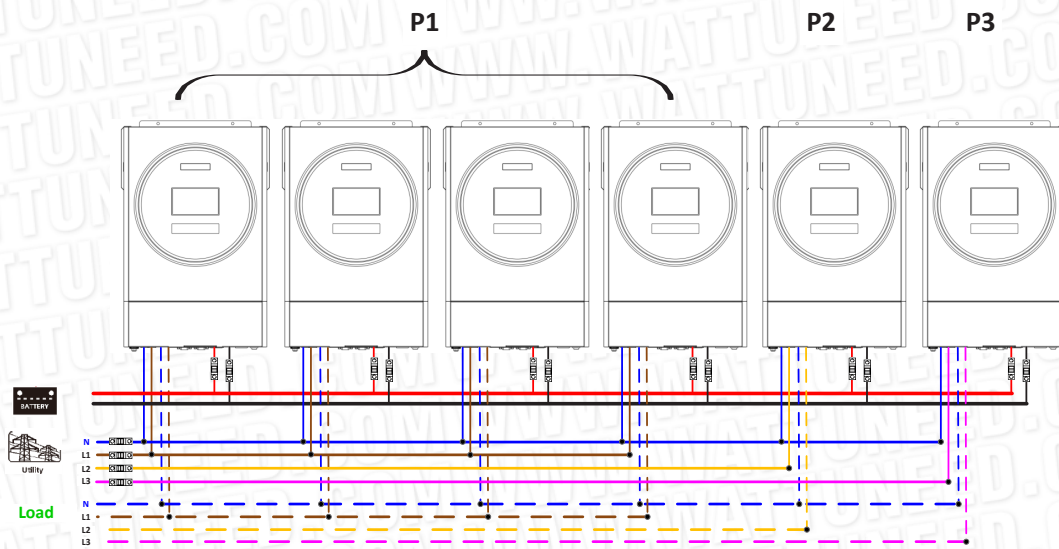

Communication Connection

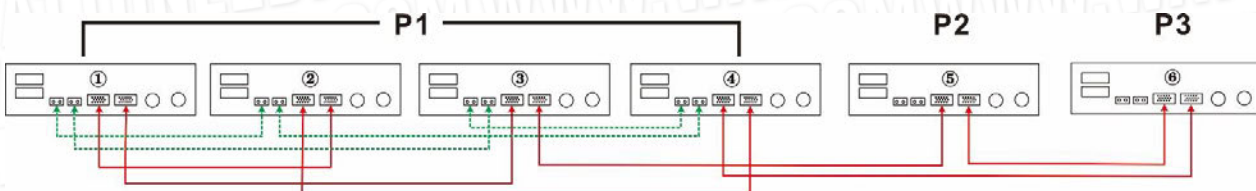

Three inverters in one phase, two inverters in second phase and one inverter for the third phase:

Power Connection

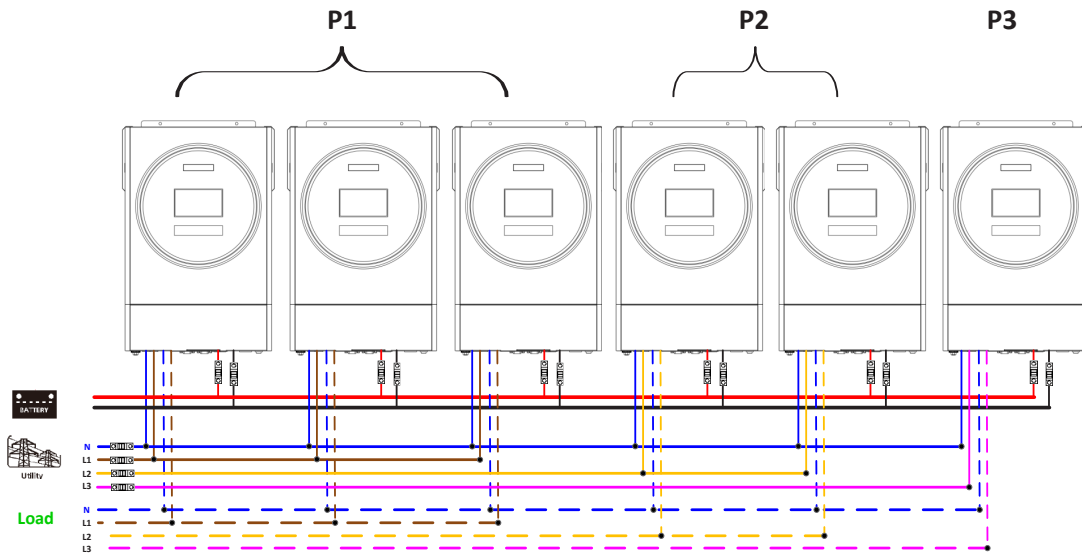

Communication Connection

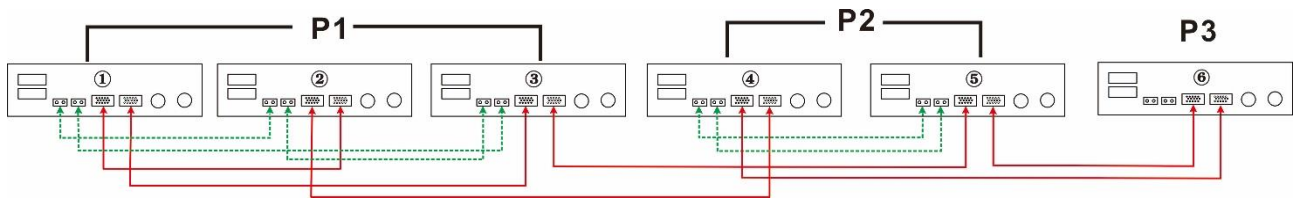

Three inverters in one phase and only one inverter for the remaining two phases:
Power Connection

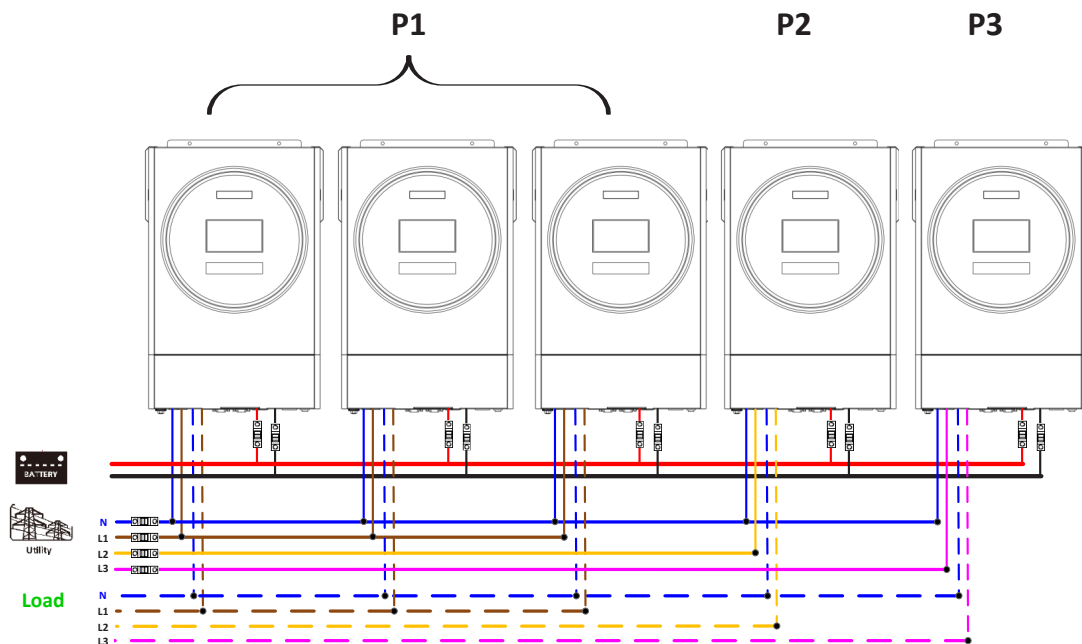

Communication Connection

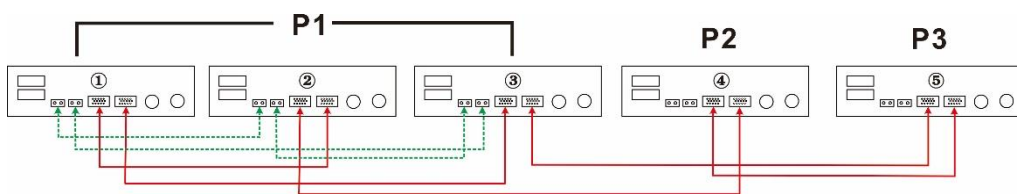

Two inverters in two phases and only one inverter for the remaining phase:

Power Connection

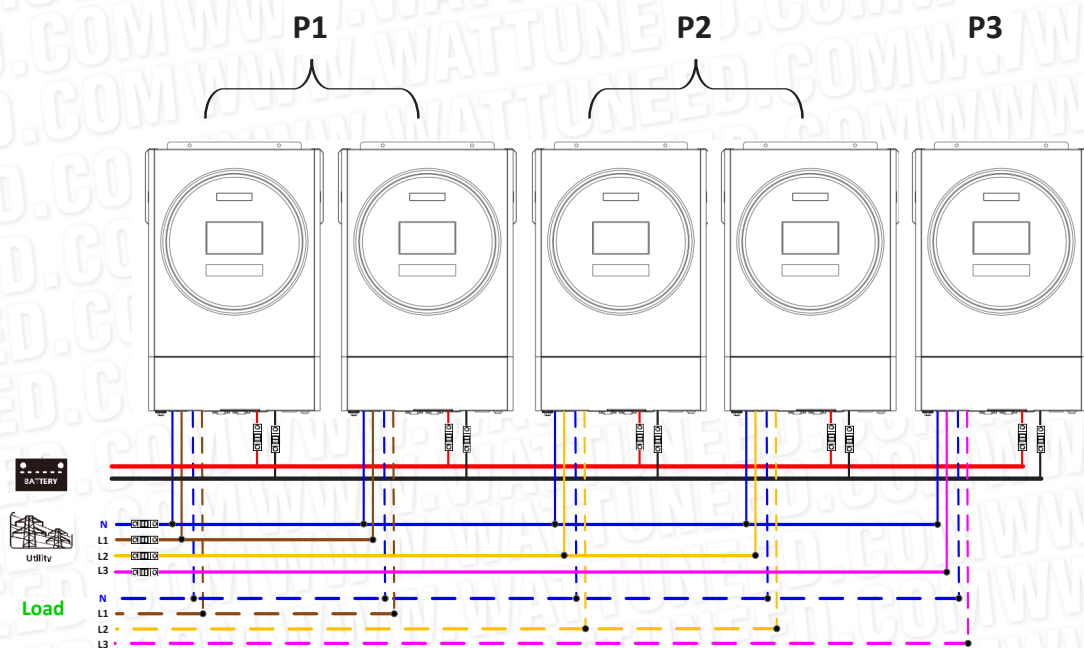

Communication Connection

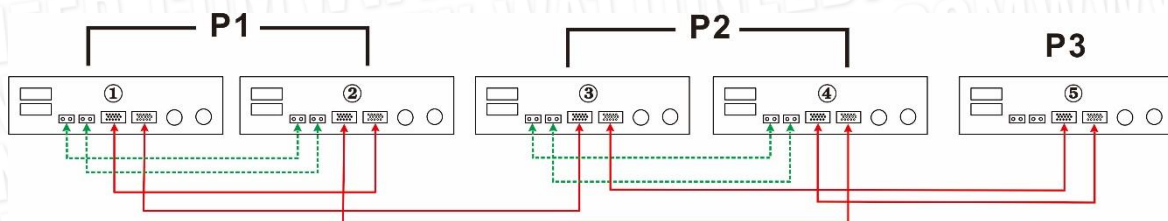

Two inverters in one phase and only one inverter for the remaining phases:

Power Connection

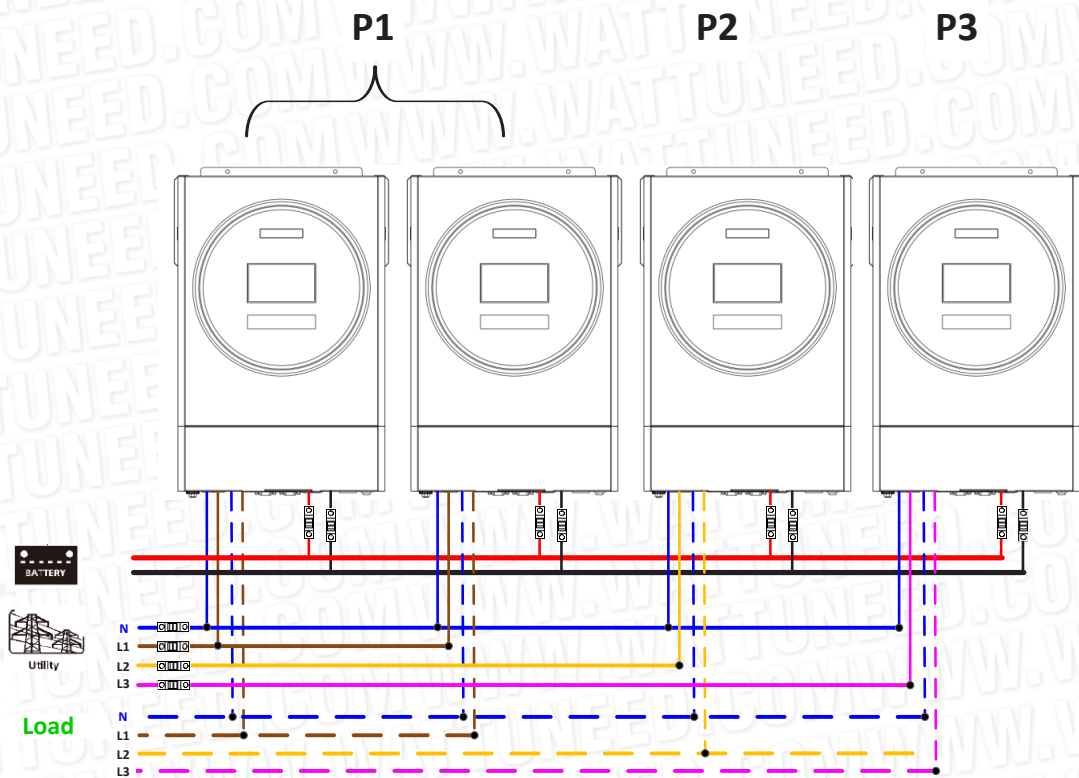

Communication Connection

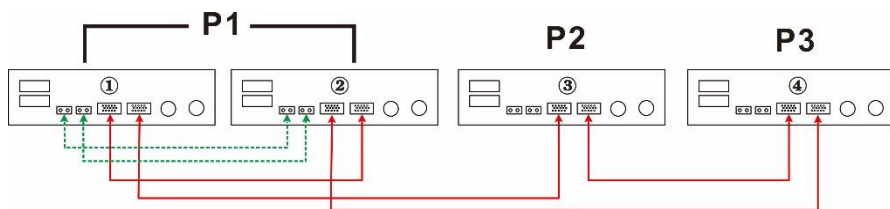

One inverter in each phase:

Power Connection

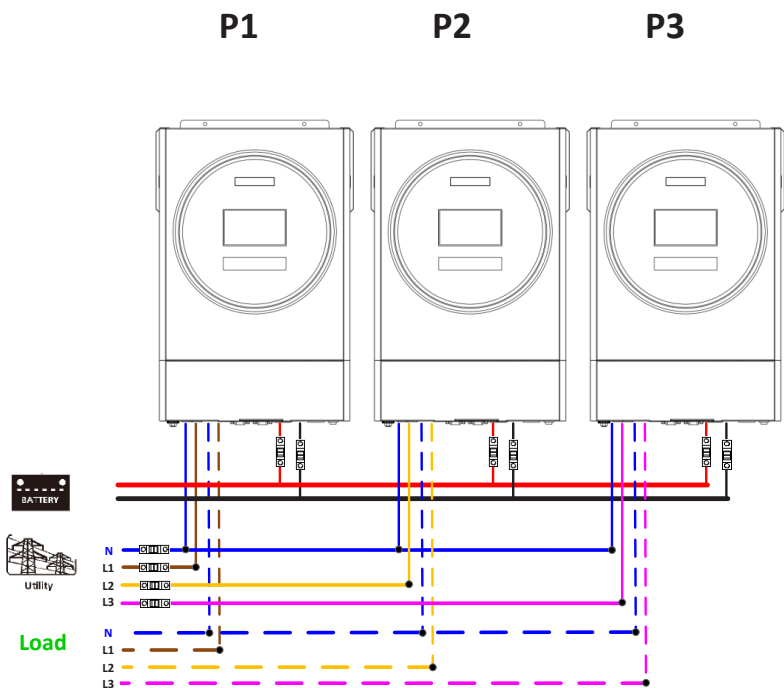

Communication Connection

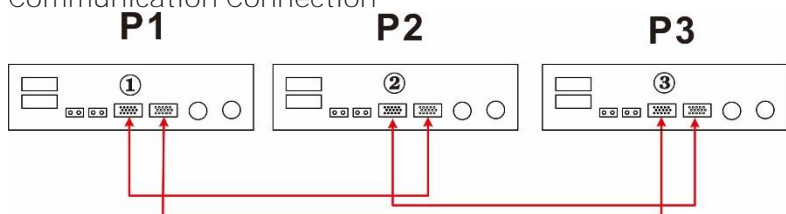

WARNING: Do not connect the current sharing cable between the inverters which are in different phases. Otherwise, it may damage the inverters.

6. PV Connection

Please refer to user manual of single unit for PV Connection.

CAUTION: Each inverter should connect to PV modules separately.

6. LCD Setting and Display

Setting Program:

Program	Description	Selectable option	
28	AC output mode *This setting is able to set up only when the inverter is in standby mode. Be sure that on/off switch is in "OFF" status.	Single	When the unit is operated alone, please select "SIG" in program 28.
		Parallel	When the units are used in parallel for single phase application, please select "PAL" in program 28. Please refer to 5-1 for detailed information.
		L1 phase:	When the units are operated in 3-phase application, please choose "3PX" to define each inverter. It is required to have at least 3 inverters or maximum 6 inverters to support three-phase equipment. It's required to have at least one inverter in each phase or it's up to four inverters in one phase. Please refers to 5-2 for detailed information. Please select "3P1" in program 28 for the inverters connected to L1 phase, "3P2" in program 28 for the inverters connected to L2 phase and "3P3" in program 28 for the inverters connected to L3 phase.
		L2 phase:	
		L3 phase:	Be sure to connect share current cable to units which are on the same phase. Do NOT connect share current cable between units on different phases.

Fault code display:

Fault Code	Fault Event	Icon on
60	Power feedback protection	F60
71	Firmware version inconsistent	F71
72	Current sharing fault	F72
80	CAN fault	F80
81	Host loss	F81
82	Synchronization loss	F82
83	Battery voltage detected different	F83
84	AC input voltage and frequency detected different	F84
85	AC output current unbalance	F85
86	AC output mode setting is different	F86

Code Reference:

Code	Description	Icon on
NE	Un-identified unit for master or slave	NE
HS	Master unit	HS
SL	Slave unit	SL

7. Commissioning

Parallel in single phase



Step 1: Check the following requirements before commissioning:

- Correct wire connection
- Ensure all breakers in Line wires of load side are open and each Neutral wires of each unit are connected together.

Step 2: Turn on each unit and set "PAL" in LCD setting program 28 of each unit. And then shut down all units.

NOET: It's necessary to turn off switch when setting LCD program. Otherwise, the setting cannot be programmed.

Step 3: Turn on each unit.

LCD display in Master unit	LCD display in Slave unit
	

NOTE: Master and slave units are randomly defined.

Step 4: Switch on all AC breakers of Line wires in AC input. It's better to have all inverters connect to utility at the same time. If not, it will display fault 82 in following-order inverters. However, these inverters will automatically restart. If detecting AC connection, they will work normally.

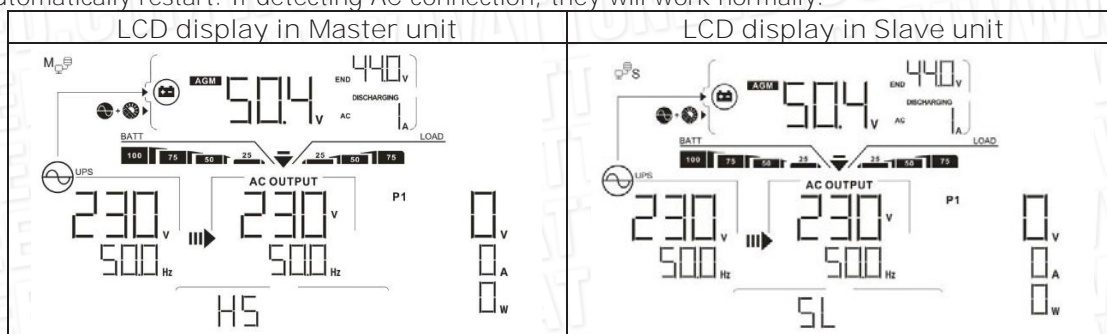

Step 5: If there is no more fault alarm, the parallel system is completely installed.

Step 6: Please switch on all breakers of Line wires in load side. This system will start to provide power to the load.

Support three-phase equipment

Step 1: Check the following requirements before commissioning:

- Correct wire connection
- Ensure all breakers in Line wires of load side are open and each Neutral wires of each unit are connected together.

Step 2: Turn on all units and configure LCD program 28 as P1, P2 and P3 sequentially. And then shut down all units.

NOET: It's necessary to turn off switch when setting LCD program. Otherwise, the setting cannot be programmed.

Step 3: Turn on all units sequentially.

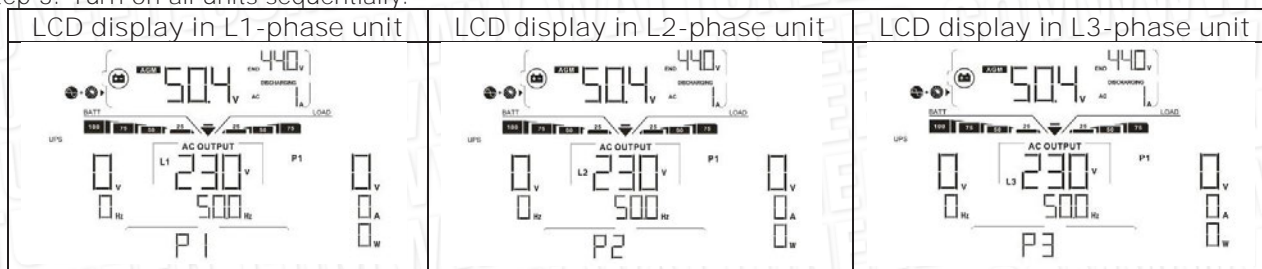

Step 4: Switch on all AC breakers of Line wires in AC input. If AC connection is detected and three phases are matched with unit setting, they will work normally. Otherwise, the AC icon will flash and they will not work in line mode.

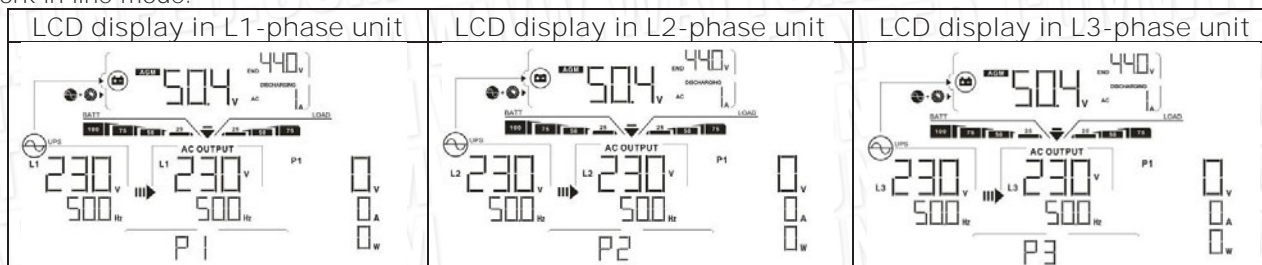

Step 5: If there is no more fault alarm, the system to support 3-phase equipment is completely installed.

Step 6: Please switch on all breakers of Line wires in load side. This system will start to provide power to the load.

Note 1: To avoid overload occurring, before turning on breakers in load side, it's better to have whole system in operation first.

Note 2: Transfer time for this operation exists. Power interruption may happen to critical devices, which cannot bear transfer time.

8. Trouble shooting

Situation			Solution
Fault Code	Fault Description	Event	
60	Current feedback into the inverter is detected.		<ol style="list-style-type: none"> Restart the inverter. Check if L/N cables are not connected reversely in all inverters. For parallel system in single phase, make sure the sharing are connected in all inverters. For supporting three-phase system, make sure the sharing cables are connected in the inverters in the same phase, and disconnected in the inverters in different phases. If the problem remains, please contact your installer.
71	The firmware version of each inverter is not the same.		<ol style="list-style-type: none"> Update all inverter firmware to the same version. Check the version of each inverter via LCD setting and make sure the CPU versions are same. If not, please contact your instraller to provide the firmware to update. After updating, if the problem still remains, please contact your installer.
72	The output current of each inverter is different.		<ol style="list-style-type: none"> Check if sharing cables are connected well and restart the inverter. If the problem remains, please contact your installer.
80	CAN data loss		<ol style="list-style-type: none"> Check if communication cables are connected well and restart the inverter. If the problem remains, please contact your installer.
81	Host data loss		
82	Synchronization data loss		
83	The battery voltage of each inverter is not the same.		<ol style="list-style-type: none"> Make sure all inverters share same groups of batteries together. Remove all loads and disconnect AC input and PV input. Then, check battery voltage of all inverters. If the values from all inverters are close, please check if all battery cables are the same length and same material type. Otherwise, please contact your installer to provide SOP to calibrate battery voltage of each inverter. If the problem still remains, please contact your installer.
84	AC input voltage and frequency are detected different.		<ol style="list-style-type: none"> Check the utility wiring connction and restart the inverter. Make sure utility starts up at same time. If there are breakers installed between utility and inverters, please be sure all breakers can be turned on AC input at same time. If the problem remains, please contact your installer.
85	AC output current unbalance		<ol style="list-style-type: none"> Restart the inverter. Remove some excessive loads and re-check load information from LCD of inverters. If the values are different, please check if AC input and output cables are in the same length and material type. If the problem remains, please contact your installer.
86	AC output mode setting is different.		<ol style="list-style-type: none"> Switch off the inverter and check LCD setting #28. For parallel system in single phase, make sure no 3P1, 3P2 or 3P3 is set on #28. For upporting three-phase system, make sure no "PAL" is set on #28. If the problem remains, please contact your installer.

Appendix II: BMS Communication Installation

1. Introduction

If connecting to lithium battery, it is recommended to purchase a custom-made RJ45 communication cable. Please check with your dealer or integrator for details.

This custom-made RJ45 communication cable delivers information and signal between lithium battery and the inverter. These information are listed below:

- Re-configure charging voltage, charging current and battery discharge cut-off voltage according to the lithium battery parameters.
- Have the inverter start or stop charging according to the status of lithium battery.

2. Pin Assignment for BMS Communication Port

	Definition
PIN 1	RS232TX
PIN 2	RS232RX
PIN 3	RS485B
PIN 4	NC
PIN 5	RS485A
PIN 6	CANH
PIN 7	CANL
PIN 8	GND

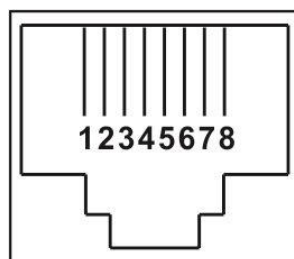

3. Lithium Battery Communication Configuration

LIO-4805/LIO-4810-150A

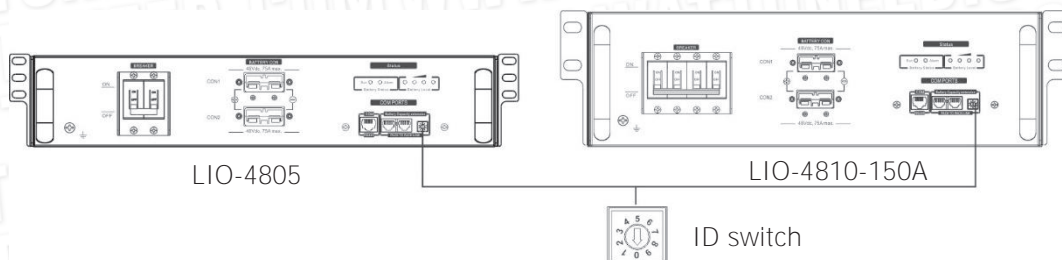

ESS LIO-I 4810

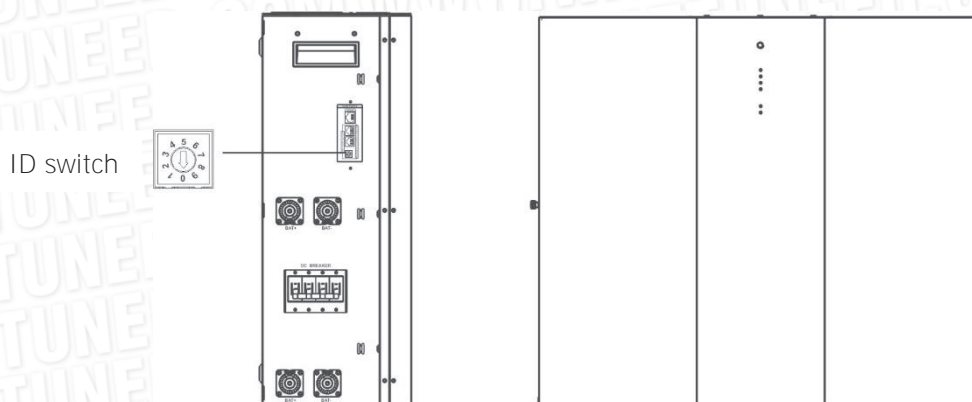

ID Switch indicates the unique ID code for each battery module. It's required to assign an identical ID to each battery module for normal operation. We can set up the ID code for each battery module by rotating the PIN number on the ID switch. From number 0 to 9, the number can be random; no particular order. Maximum 10 battery modules can be operated in parallel.

PYLONTECH

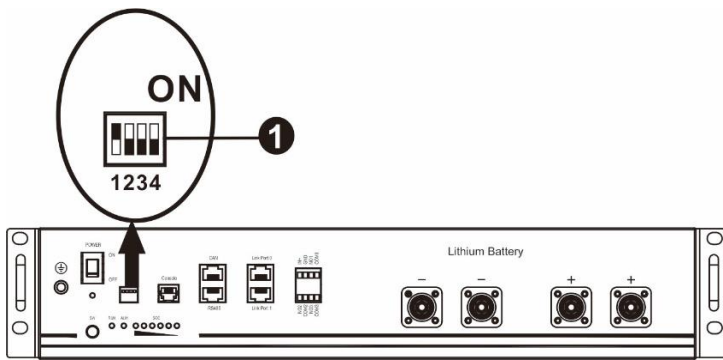

① Dip Switch: There are 4 Dip Switches that sets different baud rate and battery group address. If switch position is turned to the "OFF" position, it means "0". If switch position is turned to the "ON" position, it means "1".

Dip 1 is "ON" to represent the baud rate 9600.

Dip 2, 3 and 4 are reserved for battery group address.

Dip switch 2, 3 and 4 on master battery (first battery) are to set up or change the group address.

NOTE: "1" is upper position and "0" is bottom position.

Dip 1	Dip 2	Dip 3	Dip 4	Group address
1: RS485 baud rate=9600 Restart to take effect	0	0	0	Single group only. It's required to set up master battery with this setting and slave batteries are unrestricted.
	1	0	0	Multiple group condition. It's required to set up master battery on the first group with this setting and slave batteries are unrestricted.
	0	1	0	Multiple group condition. It's required to set up master battery on the second group with this setting and slave batteries are unrestricted.
	1	1	0	Multiple group condition. It's required to set up master battery on the third group with this setting and slave batteries are unrestricted.
	0	0	1	Multiple group condition. It's required to set up master battery on the fourth group with this setting and slave batteries are unrestricted.
	1	0	1	Multiple group condition. It's required to set up master battery on the fifth group with this setting and slave batteries are unrestricted.

NOTE: The maximum groups of lithium battery is 5 and for maximum number for each group, please check with battery manufacturer.

4. Installation and Operation

LIO-4805/LIO-4810-150A/ESS LIO-I 4810

After ID no. is assigned for each battery module, please set up LCD panel in inverter and install the wiring connection as following steps.

Step 1: Use supplied RJ11 signal cable to connect into the extension port (P1 or P2).

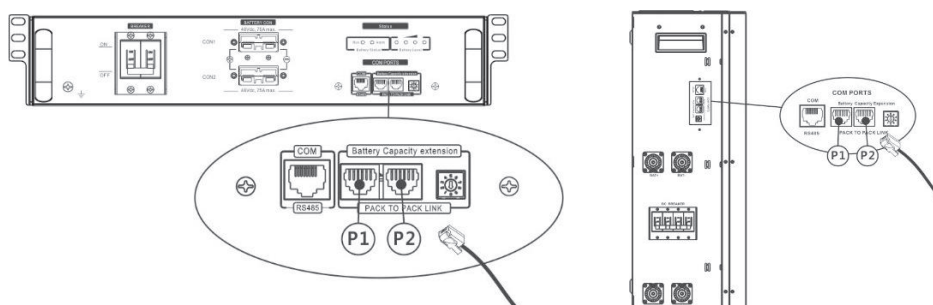

Step 2: Use supplied RJ45 cable (from battery module package) to connect inverter and Lithium battery.

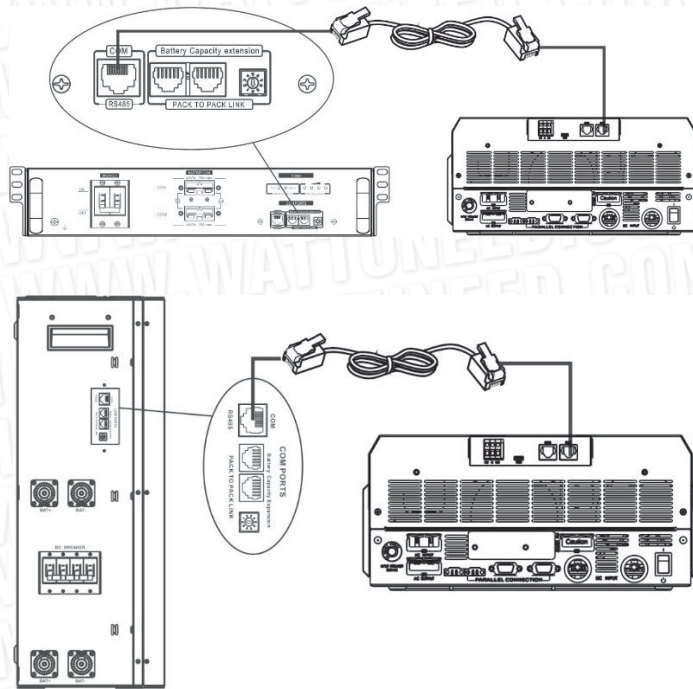

Note for parallel system:

1. Only support common battery installation.
2. Use custom-made RJ45 cable to connect any inverter (no need to connect to a specific inverter) and Lithium battery. Simply set this inverter battery type to "LIB" in LCD program 5. Others should be "USE".

Step 3: Turn the breaker switch "ON". Now, the battery module is ready for DC output.

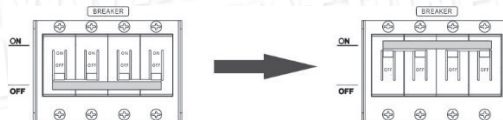

Step 4: Press Power on/off button on battery module for 5 secs, the battery module will start up.

*If the manual button cannot be approached, just simply turn on the inverter module. The battery module will be automatically turned on.

Step 5. Turn on the inverter.

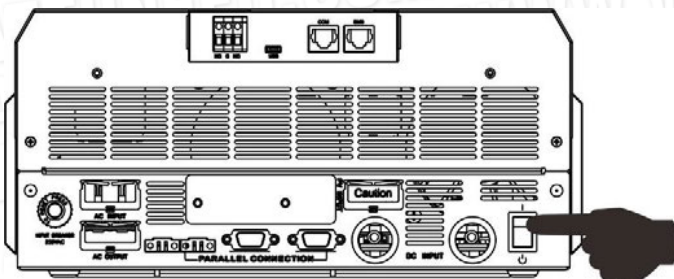

Step 6. Be sure to select battery type as "LIB" in LCD program 5.





If communication between the inverter and battery is successful, the battery icon on LCD display will flash. Generally speaking, it will take longer than 1 minute to establish communication.

PYLONTECH

After configuration, please install LCD panel with inverter and Lithium battery with the following steps.
 Step 1. Use custom-made RJ45 cable to connect inverter and Lithium battery.

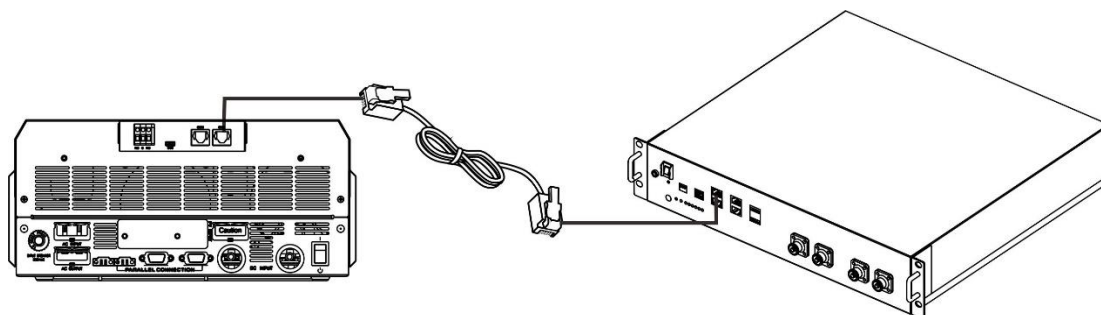

Note for parallel system:

- 3. Only support common battery installation.
- 4. Use custom-made RJ45 cable to connect any inverter (no need to connect to a specific inverter) and Lithium battery. Simply set this inverter battery type to "PYL" in LCD program 5. Others should be "USE".

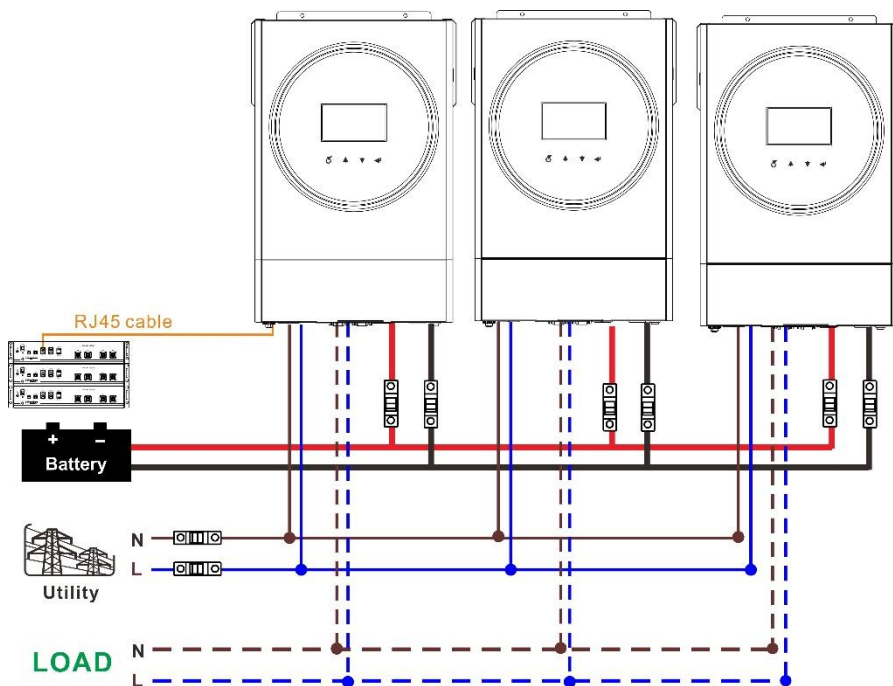

Step 2. Switch on Lithium battery.

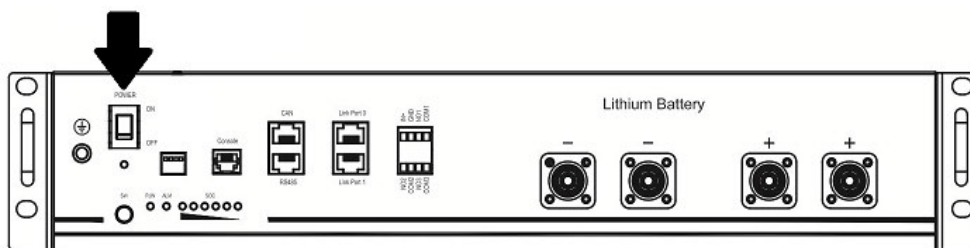

Step 3. Press more than three seconds to start Lithium battery, power output ready.

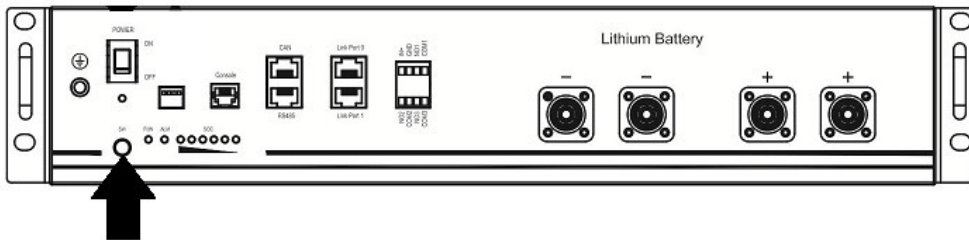

Step 4. Turn on the inverter.

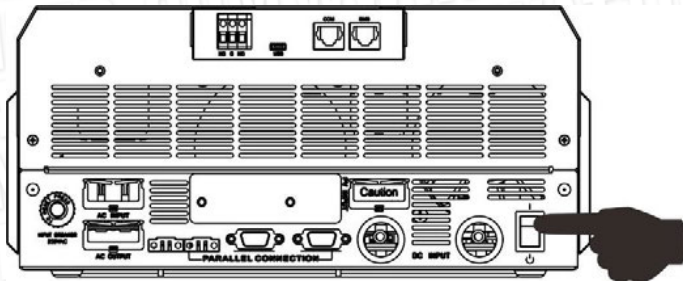

Step 5. Be sure to select battery type as "PYL" in LCD program 5.

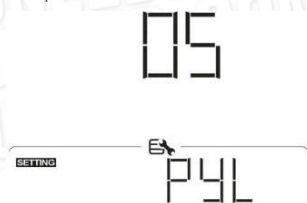

If communication between the inverter and battery is successful, the battery icon on LCD display will flash. Generally speaking, it will take longer than 1 minute to establish communication.

WECCO

Step 1. Use a custom-made RJ45 cable to connect inverter and Lithium battery.

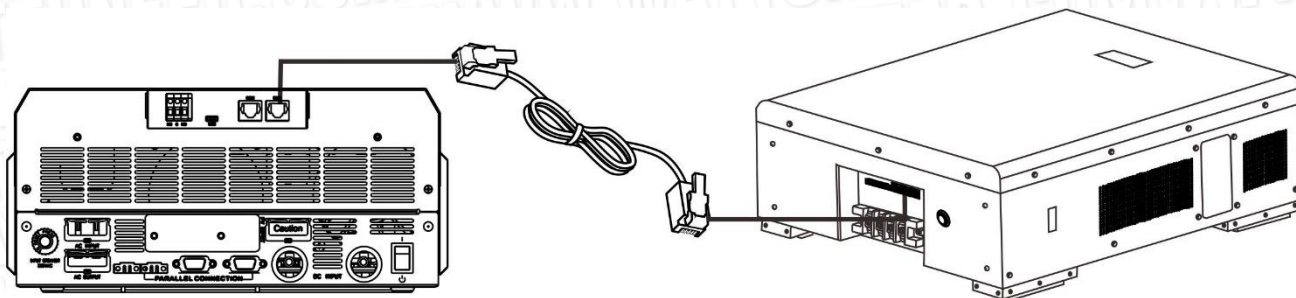

Please take notice for parallel system:

1. Only support common battery installation.
2. Use one custom-made RJ45 cable to connect any inverter (no need to connect to a specific inverter) and Lithium battery. Simply set battery type of this inverter to "WEC" in LCD program 5. The remaining inverters are set as "USE".

Step 2. Switch on Lithium battery.

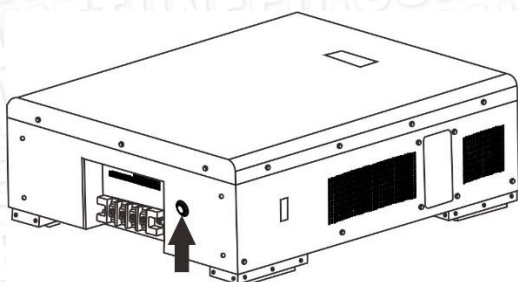

Step 3. Turn on the inverter.

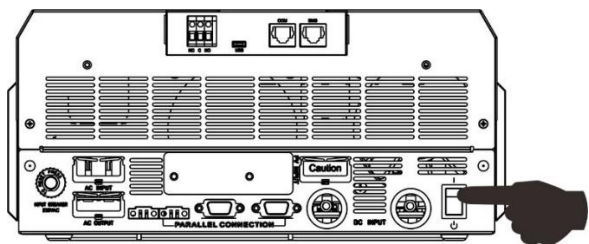

Step 4. Be sure to select battery type as "WEC" in LCD program 5.

05



If communication between the inverter and battery is successful, the battery icon on LCD display will "flash". Generally speaking, it will take longer than 1 minute to establish communication.

SOLTARO

Step 1. Use a custom-made RJ45 cable to connect inverter and Lithium battery.

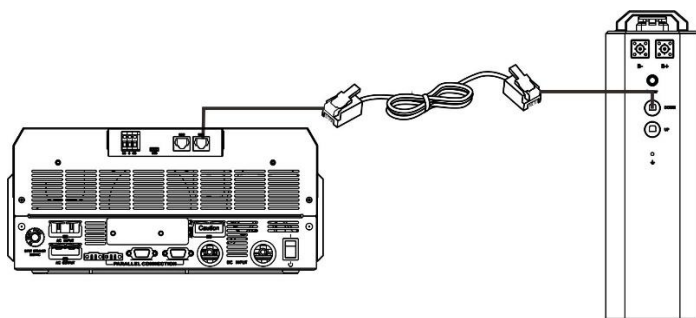

Please take notice for parallel system:

1. Only support common battery installation.
2. Use one custom-made RJ45 cable to connect any inverter (no need to connect to a specific inverter) and Lithium battery. Simply set battery type of this inverter to "SOL" in LCD program 5. The remaining inverters are set as "USE".

Step 2. Open DC isolator and switch on Lithium battery.

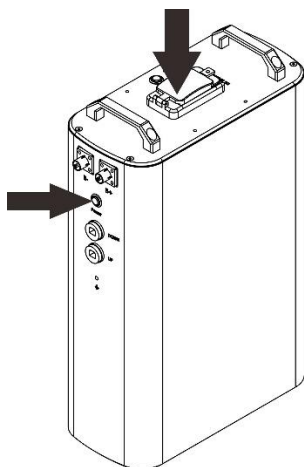

Step 3. Turn on the inverter.

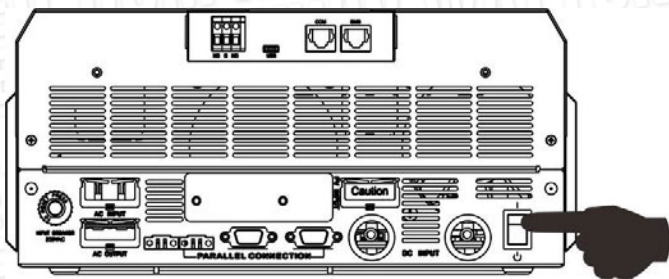

Step 4. Be sure to select battery type as "SOL" in LCD program 5.

05



If communication between the inverter and battery is successful, the battery icon on LCD display will "flash". Generally speaking, it will take longer than 1 minute to establish communication.

Active Function

This function is to activate lithium battery automatically while commissioning. After battery wiring and commissioning is successfully, if battery is not detected, the inverter will automatically activate battery if the inverter is powered on.





4. LCD Display Information

Press "▲" or "▼" button to switch LCD display information. It will show battery pack and battery group number before "Main CPU version checking" as shown below.

Selectable information	LCD display
Battery pack numbers & Battery group numbers	<p>Battery pack numbers = 3, battery group numbers = 1</p> 

5. Code Reference

Related information code will be displayed on LCD screen. Please check inverter LCD screen for the operation.

Code	Description
60 	If battery status is not allowed to charge and discharge after the communication between the inverter and battery is successful, it will show code 60 to stop charging and discharging battery.
61 	<p>Communication lost (only available when the battery type is not setting as "AGM", "Flooded" or "User-Defined".)</p> <ul style="list-style-type: none"> • After battery is connected, communication signal is not detected for 3 minutes, buzzer will beep. After 10 minutes, inverter will stop charging and discharging to lithium battery. • Communication lost occurs after the inverter and battery is connected successfully, buzzer beeps immediately.
69 	If battery status is not allowed to charge after the communication between the inverter and battery is successful, it will show code 69 to stop charging battery.
70 	If battery status must be charged after the communication between the inverter and battery is successful, it will show code 70 to charge battery.
71 	If battery status is not allowed to discharge after the communication between the inverter and battery is successful, it will show code 71 to stop discharging battery.

Appendix III: The Wi-Fi Operation Guide

1. Introduction

Wi-Fi module can enable wireless communication between off-grid inverters and monitoring platform. Users have complete and remote monitoring and controlling experience for inverters when combining Wi-Fi module with WatchPower APP, available for both iOS and Android based device. All data loggers and parameters are saved in iCloud.

The major functions of this APP:

- Delivers device status during normal operation.
- Allows to configure device setting after installation.
- Notifies users when a warning or alarm occurs.
- Allows users to query inverter history data.

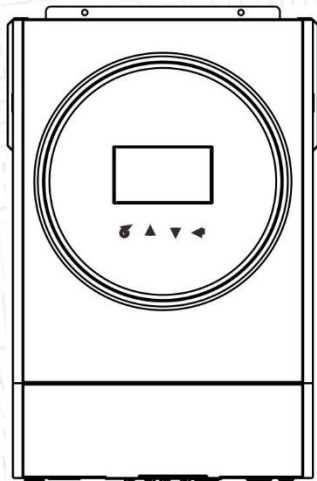

2. WatchPower App

2-1. Download and install APP

Operating system requirement for your smart phone:

- 🍏 iOS system supports iOS 9.0 and above
- 🤖 Android system supports Android 5.0 and above

Please scan the following QR code with your smart phone and download WatchPower App.



Android system





iOS system

Or you may find "WatchPower" app from the Apple® Store or "WatchPower Wi-Fi" in Google® Play Store.



2-2. Initial Setup

Step 1: Registration at first time

After the installation, please tap the shortcut icon  to access this APP on your mobile screen. In the screen, tap "Register" to access "User Registration" page. Fill in all required information and scan the Wi-Fi module PN by tapping  icon. Or you can simply enter PN directly. Then, tap "Register" button.



Then, a "Registration success" window will pop up. Tap "Go now" to continue setting local Wi-Fi network connection.

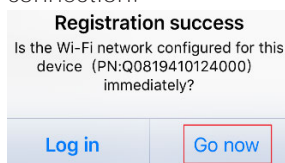

Step 2: Local Wi-Fi Module Configuration

Now, you are in "Wi-Fi Config" page. There are detailed setup procedure listed in "How to connect?" section and you may follow it to connect Wi-Fi.

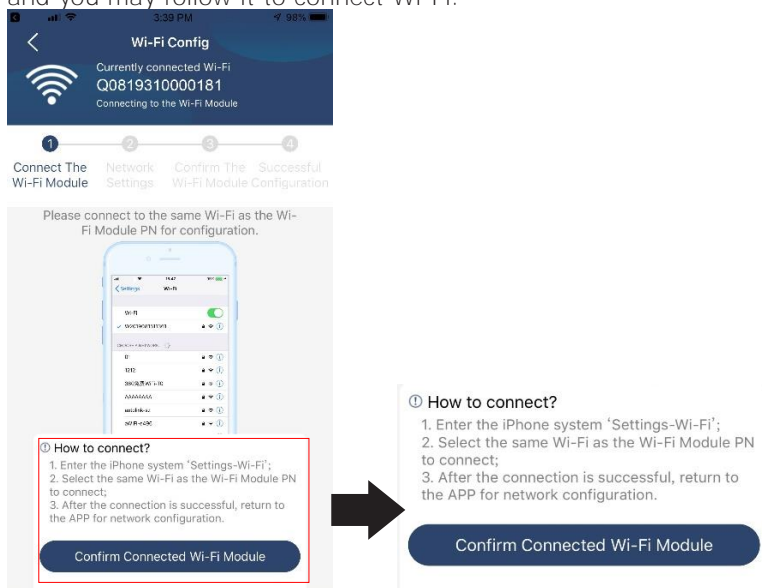

Enter the "Settings→Wi-Fi" and select connected Wi-Fi name. The connected Wi-Fi name is the same to your Wi-Fi PN number and enter default password "12345678".

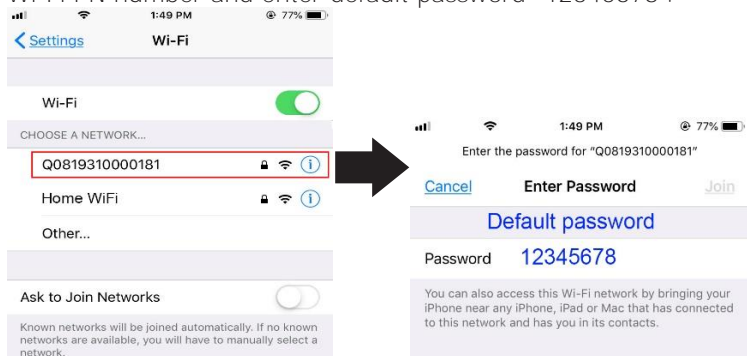

Then, return to WatchPower APP and tap "Confirm Connected Wi-Fi Module" button when Wi-Fi module is connected successfully.

Step 3: Wi-Fi Network settings

Tap icon to select your local Wi-Fi router name (to access the internet) and enter password.

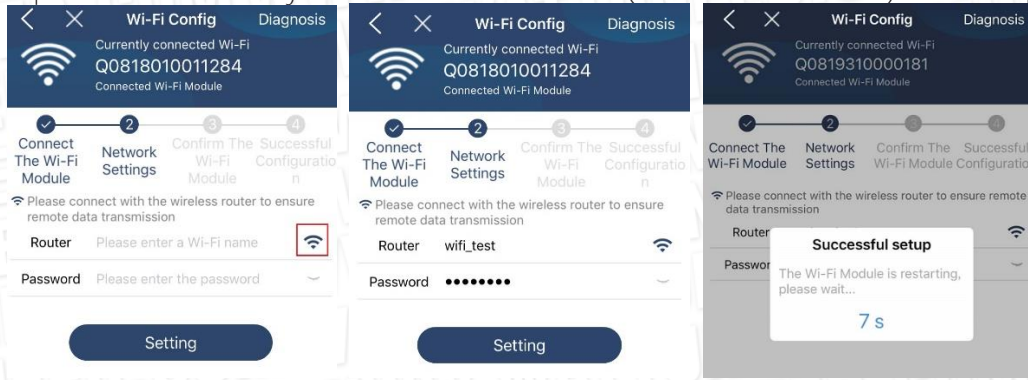

Step 4: Tap "Confirm" to complete the Wi-Fi configuration between the Wi-Fi module and the Internet.

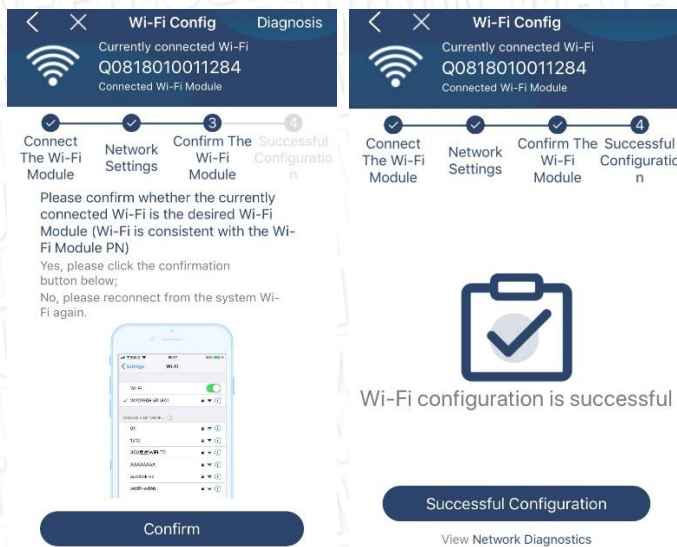

If the connection fails, please repeat Step 2 and 3.

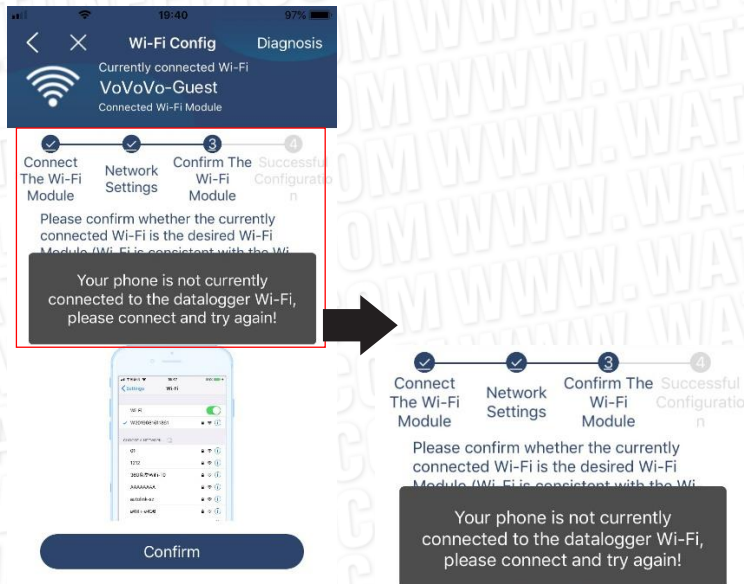

Diagnose Function

If the module is not monitoring properly, please tap **Diagnosis** on the top right corner of the screen for further details. It will show repair suggestion. Please follow it to fix the problem. Then, repeat the steps in the chapter 4.2 to re-set network setting. After all setting, tap "Rediagnosis" to re-connect again.

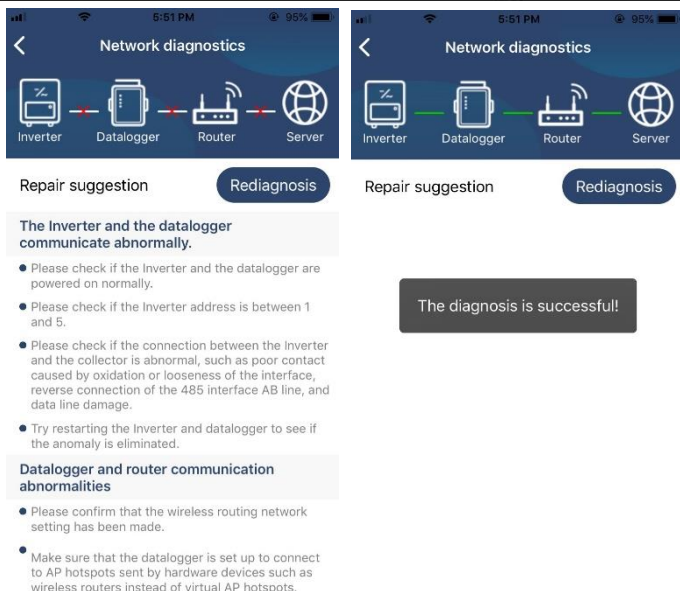

2-3. Login and APP Main Function

After finishing the registration and local Wi-Fi configuration, enter registered name and password to login.

Note: Tick "Remember Me" for your login convenience afterwards.

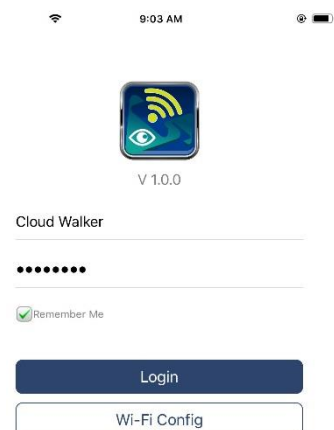

Overview

After login is successfully, you can access "Overview" page to have overview of your monitoring devices, including overall operation situation and Energy information for Current power and Today power as below diagram.

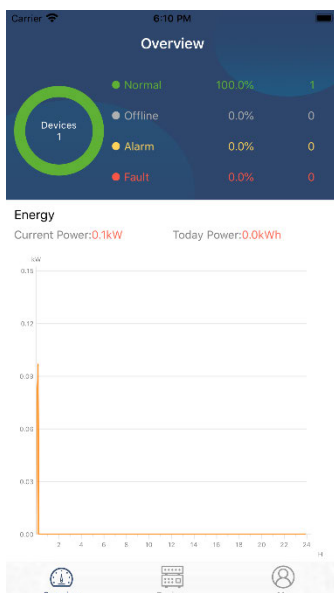

Devices

Tap the icon (located on the bottom) to enter Device List page. You can review all devices here by adding or deleting Wi-Fi Module in this page.

Add device

Delete device

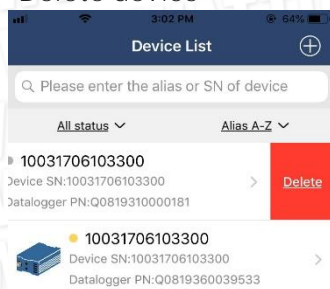
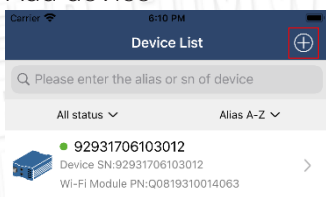

Tap icon on the top right corner and manually enter part number to add device. This part number label is pasted on the bottom of inverter. After entering part number, tap "Confirm" to add this device in the Device list.

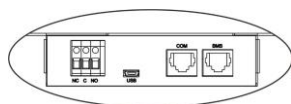
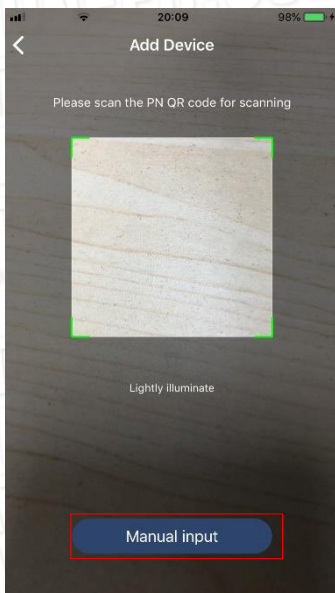

Part number label is pasted on the bottom of inverter.

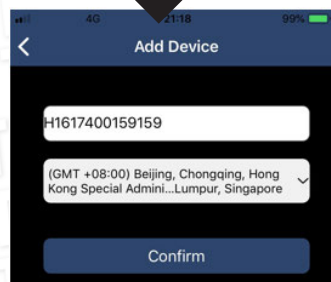
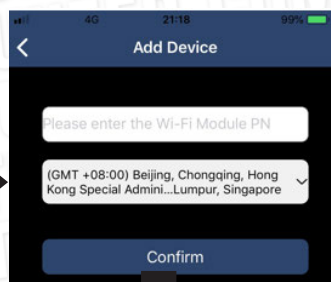

For more information about Device List, please refer to the section 2.4.

ME

In ME page, users can modify "My information", including **【User's Photo】**, **【Account security】**, **【Modify password】**, **【Clear cache】**, and **【Log-out】**, shown as below diagrams.

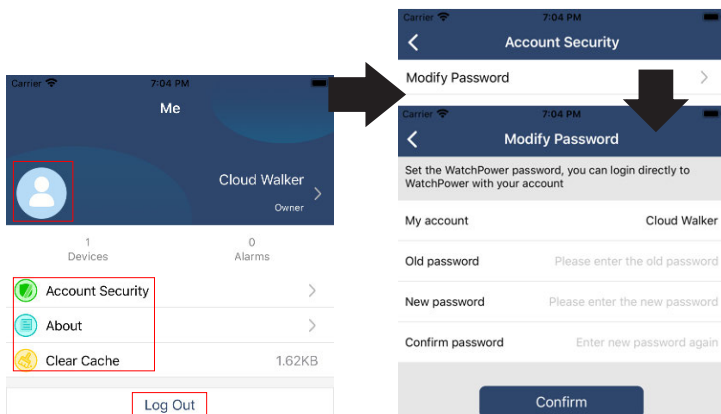

2-4. Device List

In Device List page, you can pull down to refresh the device information and then tap any device you want to check up for its real-time status and related information as well as to change parameter settings. Please refer to the parameter setting list.

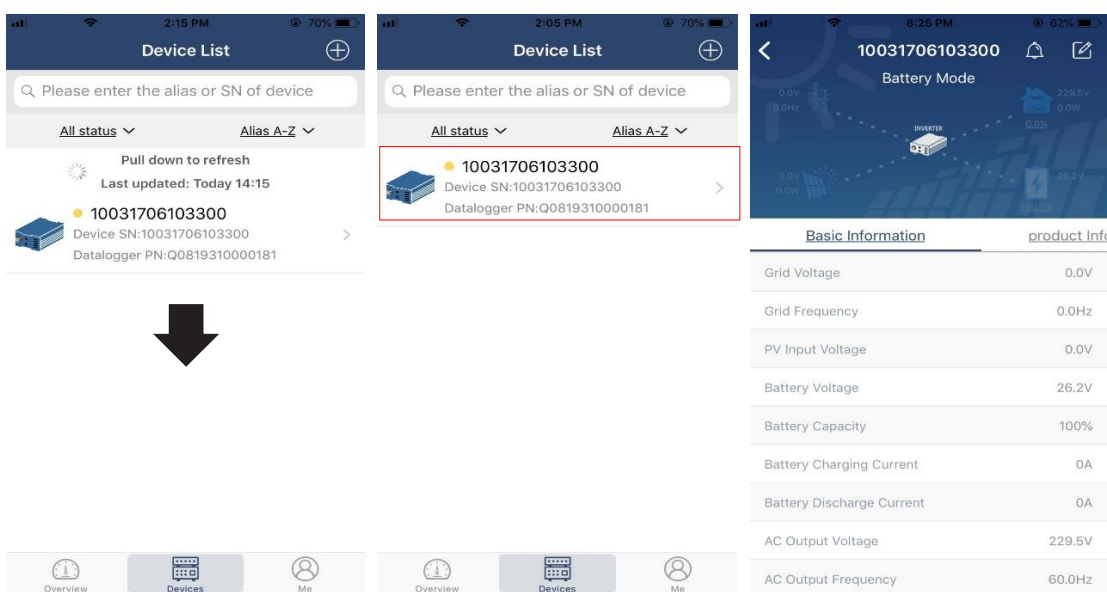

Device Mode

On the top of screen, there is a dynamic power flow chart to show live operation. It contains five icons to present PV power, inverter, load, utility and battery. Based on your inverter model status, there will be **【Standby Mode】**, **【Line Mode】**, **【Battery Mode】**.

【Standby Mode】 Inverter will not power the load until "ON" switch is pressed. Qualified utility or PV source can charge battery in standby mode.

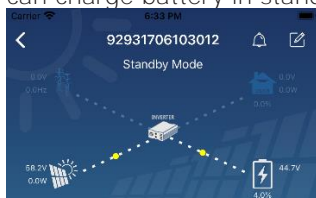

【Line Mode】 Inverter will power the load from the utility with or without PV charging. Qualified utility or PV source can charge battery.

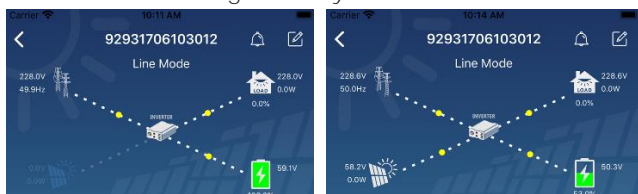

【Battery Mode】 Inverter will power the load from the batter with or without PV charging. Only PV source can charge battery.

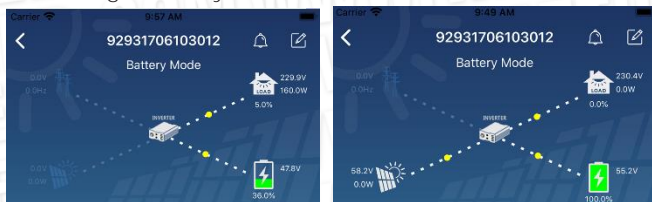

Device Alarm and Name Modification

In this page, tap the icon on the top right corner to enter the device alarm page. Then, you can review alarm history and detailed information. Tap the icon on the top right corner, a blank input box will pop out. Then, you can edit the name for your device and tap "Confirm" to complete name modification.

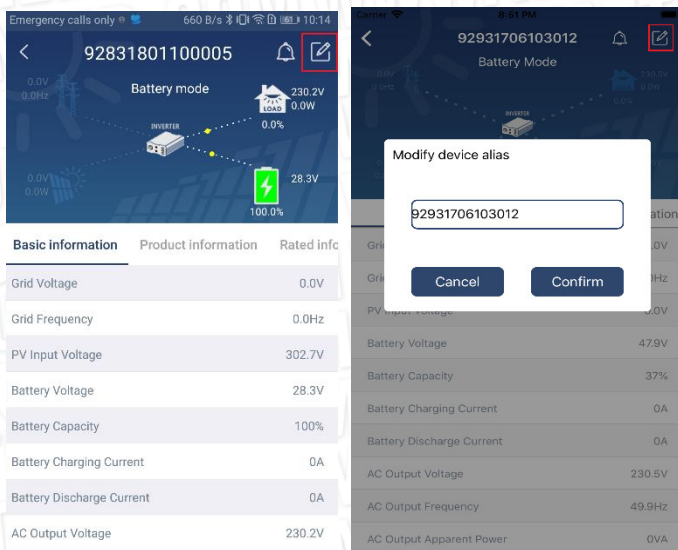

Device Information Data

Users can check up **【Basic Information】**, **【Product Information】**, **【Rated information】**, **【History】**, and **【Wi-Fi Module Information】** by swiping left.

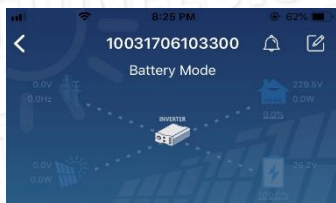

Basic Information	product Infr
Grid Voltage	0.0V
Grid Frequency	0.0Hz
PV Input Voltage	0.0V
Battery Voltage	26.2V
Battery Capacity	100%
Battery Charging Current	0A
Battery Discharge Current	0A
AC Output Voltage	229.5V
AC Output Frequency	60.0Hz

Swipe left

【Basic Information】 displays basic information of the inverter, including AC voltage, AC frequency, PV input voltage, Battery voltage, Battery capacity, Charging current, Output voltage, Output frequency, Output apparent power, Output active power and Load percent. Please slide up to see more basic information.

【Production Information】 displays Model type (Inverter type), Main CPU version, Bluetooth CPU version and secondary CPU version.

【Rated Information】 displays information of Nominal AC voltage, Nominal AC current, Rated battery voltage, Nominal output voltage, Nominal output frequency, Nominal output current, Nominal output apparent power and Nominal output active power. Please slide up to see more rated information.

【History】 displays the record of unit information and setting timely.

【Wi-Fi Module Information】 displays of Wi-Fi Module PN, status and firmware version.

Parameter Setting

This page is to activate some features and set up parameters for inverters. Please be noted that the listing in “Parameter Setting” page in below diagram may differ from the models of monitored inverter. Here will briefly highlight some of it, 【Output Setting】 , 【Battery Parameter Setting】 , 【Enable/ Disable Items】 , 【Restore to the defaults】 to illustrate.

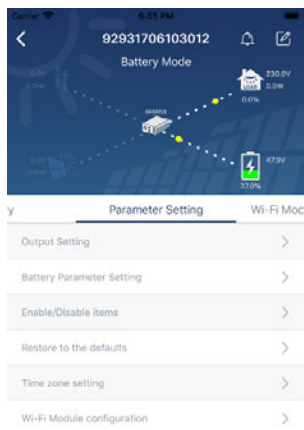

There are three ways to modify setting and they vary according to each parameter.

- a) Listing options to change values by tapping one of it.
- b) Activate/Shut down functions by clicking “Enable” or “Disable” button.
- c) Changing values by clicking arrows or entering the numbers directly in the column.

Each function setting is saved by clicking “Set” button.

Please refer to below parameter setting list for an overall description and be noted that the available parameters may vary depending on different models. Please always see the original product manual for detailed setting instructions.

Parameter setting list:

Item	Description
Output setting	Output source priority To configure load power source priority.
	AC input range When selecting "UPS", it's allowed to connect personal computer. Please check product manual for details. When selecting "Appliance", it's allowed to connect home appliances.
	Output voltage To set output voltage.
	Output frequency To set output frequency.
Battery parameter setting	Battery type: To set connected battery type.
	Battery cut-off voltage To set the battery stop discharging voltage. Please see product manual for the recommended voltage range based on connected battery type.
	Back to grid voltage When "SBU" or "SOL" is set as output source priority and battery voltage is lower than this setting voltage, unit will transfer to line mode and the grid will provide power to load.
	Back to discharge When "SBU" or "SOL" is set as output source priority and battery voltage is higher than this setting voltage, battery will be allowed to

	voltage	discharge.
	Charger source priority:	To configure charger source priority.
	Max. charging current	
	Max. AC charging current:	It's to set up battery charging parameters. The selectable values in different inverter model may vary. Please see product manual for the details.
	Float charging voltage	
	Bulk charging voltage	It's to set up battery charging parameters. The selectable values in different inverter model may vary. Please see product manual for the details.
	Battery equalization	Enable or disable battery equalization function.
	Real-time Activate Battery Equalization	It's real-time action to activate battery equalization.
	Equalized Time Out	To set up the duration time for battery equalization.
	Equalized Time	To set up the extended time to continue battery equalization.
	Equalization Period	To set up the frequency for battery equalization.
	Equalization Voltage	To set up the battery equalization voltage.
Enable/Disable Functions	LCD Auto-return to Main screen	If enable, LCD screen will return to its main screen after one minute automatically.
	Fault Code Record	If enabled, fault code will be recorded in the inverter when any fault happens.
	Backlight	If disabled, LCD backlight will be off when panel button is not operated for 1 minute.
	Bypass Function	If enabled, unit will transfer to line mode when overload happened in battery mode.
	Beeps while primary source interrupt	If enabled, buzzer will alarm when primary source is abnormal.
	Over Temperature Auto Restart	If disabled, the unit won't be restarted after over-temperature fault is solved.
	Overload Auto Restart	If disabled, the unit won't be restarted after overload occurs.
	Buzzer	If disabled, buzzer won't be on when alarm/fault occurred.
RGB LED Setting	Enable/disable	Turn on or off RGB LEDs
	Brightness	Adjust the lighting brightness
	Speed	Adjust the lighting speed
	Effects	Change the light effects
	Color Selection	Adjust color by setting RGB value
Restore to the default	This function is to restore all settings back to default settings.	