

SOFAR

USER MANUAL

SOFAR GTX5000-PRO

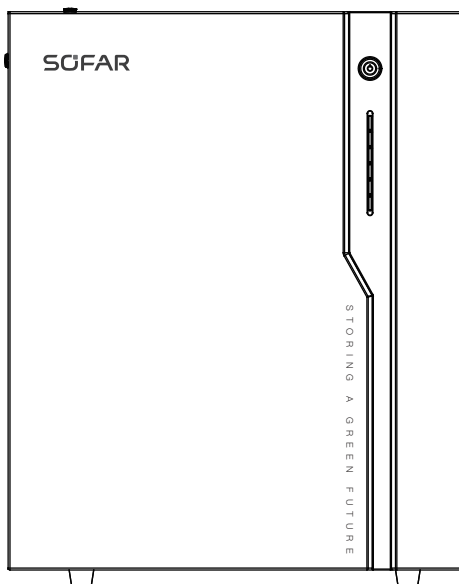

Shenzhen SOFARSOLAR Co., Ltd

Contents

1 General Information	1
1.1 Validity	1
1.2 Intended Use	1
1.3 Identifying The Product	3
2 Safety	4
3 Technical Items	6
4 Product Overview	7
4.1 Brief Introduction	7
4.2 Interface Introduction (Front Side)	8
4.2.1 Start Button	9
4.2.2 LED Indicator Definition	10
4.3 Interface Introduction (Left Side)	11
4.3.1 Wiring instructions	12
4.3.2 Link Port and Automatic Coding Function	15
4.3.3 CAN / RS485 Port	16
4.3.4 RS232 Port	17

5 Installation Guide	18
5.1 Checking Before Installation	18
5.1.1 Checking Outer Packing Materials	18
5.1.2 Checking Deliverables	19
5.2 Tools	23
5.3 Installation Requirements	23
5.3.1 Installation Environment Requirements	23
5.3.2 Installation Carrier Requirements	24
5.4 Installation Instructions	25
5.4.1 Dimensions	25
5.4.2 Installation Step	27
5.5 Electrical Connection	30
5.5.1 Electrical Connection Process	30
5.5.2 Wiring Step	30
5.5.3 Parallel System Wiring Step	34
6 Cleaning and Maintenance	35
6.1 Cleaning	35
6.2 Maintenance	35

6.2.1 Recharge Requirements During Normal Storage	35
6.2.2 Recharge Requirements When Over Discharged	36
6.2.3 Replacement or Expand capacity	37
6.2.4 Emergency	37
7 Technical data	39

Preface

Notice

The purchased products, services and features are governed by the commercial contract made by the Company. All or part of the products and features described in this document may not be within the purchase scope. Except as otherwise agreed herein, no representations or warranties, express or implied, are made as to the contents of this document.

Save this Instruction

This manual must be considered as an integral part of the equipment. Customer can print the electronic version to hard copy and keeping properly for future reference. Anyone who operates the device at any time must operate in accordance with the requirements of this manual.

Copyright Declaration

The copyright of this manual belongs to Shenzhen SOFARSOLAR Co., Ltd. Any corporation or individual should not plagiarize, partially cope or fully copy (including software, etc.), not allow to duplication and

publication in any form and any way. All rights reserved, SOFARSOLAR reserves the right of final interpretation. This manual subject to modify according to user's or customer's feedback. Please check our website at <http://www.sofarsolar.com> for lasted version.

Document Updates

V2.0 2023-02-24

1 General Information

This manual introduces GTX5000-PRO LFP Battery Product from SOFAR. Please read this manual before you use the battery.

Any confusion, please contact SOFAR immediately for advice and clarification.

1.1 Validity

This user manual is applicable to SOFAR GTX5000-PRO.

This user manual contains SOFAR GTX5000-PRO product information, usage guidance, safety information, installation guide and details on common operating issues and subsequent corrective actions.

1.2 Intended Use

SOFAR GTX5000-PRO is an energy storage unit that is designed to be used in residential on-grid applications with the capability for short-term backup.

Notes regarding intended use:

SOFAR GTX5000-PRO is not suitable for supporting life-sustaining medical

devices.

This product is intended for use only in accordance with the information provided in the enclosed documentation and with the locally applicable standards and regulations. Any other application may cause personal injury or property damage.

The illustrations in this manual are meant only to help explain system configuration concepts, includes usage guidance, safety precautions, and common operating issues and subsequent corrective actions.

Alterations to the product, e.g. changes or modifications, are only permitted with the express written permission of SOFAR. Unauthorized alterations will void warranty claims. SOFAR shall not be held liable for any damage caused by such changes. Any use of the product other than that described in the Intended Use section does not qualify as appropriate. The enclosed documentation is an integral part of this product. Keep the documentation in a convenient place for future reference and observe all instructions contained therein. The type label (see Section 1.3) must remain attached to the product.

Please contact SOFAR or local after-service providers within 1 week once the user decides to cease using their SOFAR Battery products.

1.3 Identifying The Product

The type labels were attached on the product, which contain the product identification information. For safe usage, the user must be well-informed of the contents in the type labels.

The type labels include:

SOFAR *Rechargeable Li-ion Battery*

IFpP/51/161/120/[1P16S]M/-20+60/90

Model: GTX5000-PRO

Ratings: 5120Wh/51.2V/100Ah

Charge Voltage: 56.16V

Max. Output Power: 5KW

Guangdong Sofar Smart Solar Technology Co., Ltd.
 3/F.-4/F., Building No.4, Plant of Area D,
 Qiaosheng Industrial Park, Lizhen Road,
 Panli Village, Lili Town, Zhongkai High-tech
 Zone, Huizhou City, Guangdong, China

CAUTION !

- Do not disassemble
- Do not short-circuit
- Do not place in fire or near hot source
- Please read user manual carefully

IEC 62619
UN 38.3

DANGER !

CHEMICAL HAZARD & SHOCK HAZARD

- Do not disassemble or repair by yourself.
- Do not drop, deform, impact, cut or spearing with a sharp object.
- Do not place near open flame or incinerate.
- Do not put any objects onto the battery.
- Do not allow to contact with liquid.
- Keep out of reach of children, animals or insects.
- Contact the supplier within 24 hours if anything wrong.

WARNING !

Stop the battery operation immediately to secure the battery safety when environmental temperature is over working temperature (suitable operation temperature is 0-45°C).
 If battery is at high temperature usually, it will impact battery performance.

2 Safety

This section contains safety information that must be observed at all times when working on or with batteries. To prevent personal injury or property damage and to ensure long-term operation of the batteries, read this section carefully and observe all safety information at all times.



WARNING

Environmental Requirement

Do not expose the battery to temperature above 50°C

Do not place the battery near any heat sources

Do not expose the battery to moisture or liquids

Do not expose the battery to corrosive gases or liquids

Do not expose the battery to direct sunlight for extended periods of time

Do not allow the battery power terminals to touch conductive objects such as wires

Place battery in secure location away from children and animals

Operation Precautions

Do not disassemble the battery

Do not touch the battery pack with wet hands

Do not crush, drop or puncture the battery

Do not reverse the polarity or connect in series

Do not short circuit the terminals, remove all jewelry items that could product a short circuit before installation and handling

Always dispose of the product according to local safety regulations

Store and recharge battery in a manner in accordance with this user manual

Ensure reliable grounding

Disconnect battery from power/load and then power off battery before installation and maintenance

When storing or handing, do not stack up batteries when outside protective package

Packaged batteries should not be stacked more than specified number stipulated on the package

Continued operation of a damaged battery can result in dangerous situation that may cause severe injury due to electrical shock.

3 Technical Items

No.	Terms	Comment
1	Discharge	Battery output power for load
2	Charge	To put electricity into battery by charger
3	Full charge	Battery had been full charged, SOC is 100%.
4	Standby	Ready for charging or discharging
5	Shutdown	Power off
6	SOC	State of Charge(Useable capacity)
7	Battery voltage	The voltage between B+/B-
8	Cell voltage	Single cell voltage
9	Pack voltage	The voltage between P+/P-
10	Alarm	Indicate that the battery is in abnormal status
11	Protect	Battery stops charging or discharging and is recoverable
12	Fault	Battery or BMS is broken, need to be replaced
13	Over discharged	Battery is lack of electricity, and needs to be recharged in time

4 Product Overview

4.1 Brief Introduction



Product overview

SOFAR GTX5000-PRO is a battery system with an operating voltage range between 45.6~56.16V. It is utilized in household energy storage applications and works together with a low-voltage PCS to realize the goal of energy storage for the home.

SOFAR GTX5000-PRO has built-in BMS (battery management system), which

can manage and monitor cells information including voltage, current and temperature. What’s more, BMS can balance cells charging to extend cycle life. BMS has protection functions including over-discharge, over-charge, over-current and high/low temperature; the system can automatically manage charge state, discharge state and balance state.

Multiple batteries can connected in parallel to expand capacity and power for larger capacity and longer power supporting duration requirements, SOFAR GTX5000-PRO support up to 4 parallel operation.

4.2 Interface Introduction (Front Side)

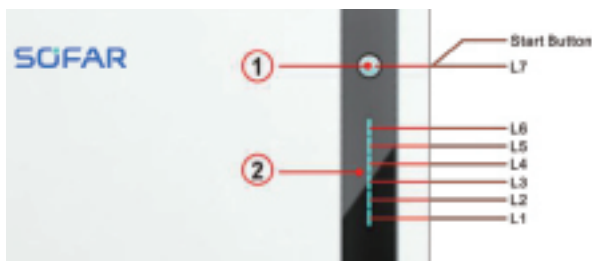

No.	Items
1	Start Button Status Indicators
2	Battery Level Indicator

4.2.1 Start Button

Start button integrated LED status Indicators, to show Battery running status or warning status.

1、 Press start button more than 3s and then release the button, LED will lights from L7 to L1, and then enters to automatic coding, all LED lights flash and L7 is shown as purple. After the automatic coding, L1 to L6 shows the normal capacity, and L7 shows the running status:

L7: Blue, long lighting when charging and flash when discharging;

L7: Red, long bright if equipment failure or protected.

2、 In parallel system, connect the parallel communication wiring according to section 5.3.1, then long press the start button of the **Master PACK**, after normal startup, the battery system will automatically encode and assign ID to each parallel PACK, and then the parallel system will run normally.

3、 Press start button of **Master PACK** more than 3s and then release the button, LED will lights from L1 to L7 to shut down the battery module. In parallel system, the master pack will shut down after all slave packs shut down.

4.2.2 LED Indicator Definition

L1 to L6: Blue, show the battery level, each light indicate 16.67% SOC.

L7: Blue or Red, show battery running status, blue is normal, red is abnormal.

LED Indicators Instructions

Status		RUN	ALM	Battery Level Indicator						Descriptions
		L7	L6	L5	L4	L3	L2	L1		
Shut down		OFF	OFF	OFF	OFF	OFF	OFF	OFF	OFF	All OFF
Standby		Flash 1	OFF	According to the battery level						Indicates Standby
Charging	Normal	Light	OFF	According to the battery level						The highest capacity indicator LED flashes (flash 2), others lighting
	Full Charged	Light	OFF	Light	Light	Light	Light	Light	Light	Turn to standby status when charger off
	Protection	OFF	Light	OFF	OFF	OFF	OFF	OFF	OFF	Stop charging
Discharging	Normal	Flash 3	OFF	According to the battery level						
	UVP	OFF	OFF	OFF	OFF	OFF	OFF	OFF	OFF	Stop discharging
	Protection	OFF	Light	OFF	OFF	OFF	OFF	OFF	OFF	Stop discharging
Fault		OFF	Light	OFF	OFF	OFF	OFF	OFF	OFF	Stop Charging and Discharging

Charging Battery Level Indicators Instructions

Status		Charging						
Battery Level Indicators		L7	L6	L5	L4	L3	L2	L1
Battery Level (%)	0~17%	Light	OFF	OFF	OFF	OFF	OFF	Flash2
	18~33%		OFF	OFF	OFF	OFF	Flash 2	Light
	34~50%		OFF	OFF	OFF	Flash 2	Light	Light
	51~66%		OFF	OFF	Flash 2	Light	Light	Light
	67~83%		OFF	Flash 2	Light	Light	Light	Light
	84~100%		Flash 2	Light	Light	Light	Light	Light

Discharging Battery Level Indicators Instructions

Status		Discharging						
Battery Level Indicators		L7	L6	L5	L4	L3	L2	L1
Battery Level (%)	0~17%	Flash 3	OFF	OFF	OFF	OFF	OFF	Light
	18~33%		OFF	OFF	OFF	OFF	Light	Light
	34~50%		OFF	OFF	OFF	Light	Light	Light
	51~66%		OFF	OFF	Light	Light	Light	Light
	67~83%		OFF	Light	Light	Light	Light	Light
84~100%		Light	Light	Light	Light	Light	Light	

Note: The flashing instructions, flash 1 - light 0.25s / off 3.75 seconds; flash 2 - 0.5s light / 0.5s off; flash 3 - 0.5s light / 1.5s off.

4.3 Interface Introduction (Left Side)

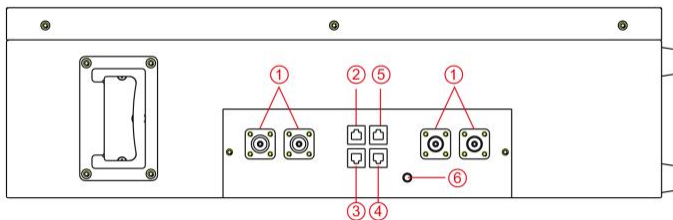

No.	Items	No.	Items
1	Power Terminals	4	Link Port Out
2	CAN/RS485	5	RS232
3	Link Port In	6	Grounding

4.3.1 Wiring instructions

Applicable to CEC requirements in Australia only.

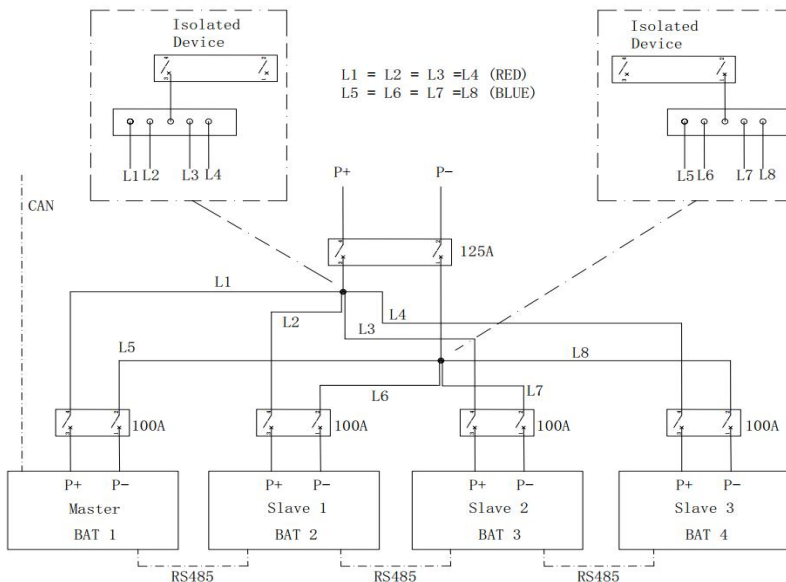

Note:

- 1、 Power Switch larger than 125A;
- 2、 You are advised to use the EV power cable with size min. 25 mm² or 3AWG (600V, 125A) and length min.1500mm. The length of the power cable from connector terminals of each battery pack to the battery connector interface of PCS should be same by isolated device.

- 3、 Before assembling Power cable, label the cable polarities correctly to ensure correct cable connections.
- 4、 The power cable installation and connected must training skilled of professional personal.

Suggest Wiring Diagram (except CEC):

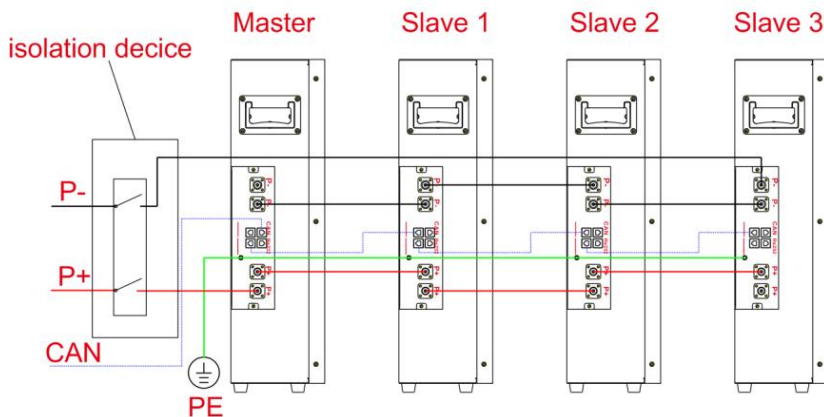

1、 Power cable wiring instructions

Power cable terminals: there are two pair of power terminals, each pair with same function.

Single module: Any of the terminals of each pair can be used.

Parallel system:

Multiple batteries can be connected in parallel to expand capacity and power for larger capacity and longer power supporting duration requirements.

NOTE: P+ must connect to master pack, and P- must connect to last slave pack.

Master pack: one of the P+ terminals connect to PCS, the other one paralleling to another battery for capacity expanding.

Last slave pack: one of the P- terminals connect to equipment, the other one paralleling to another battery for capacity expanding.

Other slave pack: for each pair terminals, paralleling to another battery for capacity expanding.

2、Parallel communication cable wiring instructions

Link Port In / Link Port Out communication terminal (RJ45 port) is integrated with the signal for automatic coding function, it's can automatic identification the parallel connected slave batteries by internal control software of master battery.

NOTE: The connection order of Port In and Port Out should not be wrong, otherwise it will lead to the automatic coding failed.

It is required that the Port In of the master PACK do not connected to the communication line, and the parallel communication wire is connected to the Port

In of the first slave PACK from the Port Out of the master PACK. Then the Port Out of the first slave PACK is connected to the Port In of the second slave PACK. The Port Out of the second slave PACK is then connected to the Port In of the third slave PACK. The parallel system support up to 4 parallel operation, and Port Out of the last slave PACK do not connected to the communication line.

3、PCS communication cable wiring instructions

The CAN communication port of the **Master pack** is connected to PCS.

4、Grounding wiring instructions

The ground wire of the battery system needs to be connected reliably. Connect the grounding of the parallel system first, and then ground it nearby through the connection point of one of the battery packs.

4.3.2 Link Port and Automatic Coding Function

Link Port In / Link Port Out Communication follow RS485 protocol, for communication between multiple parallel batteries.

After confirming the wiring is correct(refer to section 4.3.1), long press the startup button of the **Master PACK**, after normal startup, the parallel battery system will automatically code and assign ID to each parallel PACK, and then the parallel system will run normally(refer to section 4.2.1).

4.3.3 CAN / RS485 Port

CAN / RS485 Communication Terminal(RJ45 port) follow CAN protocol / RS485 protocol, connect to communication port.

- 1、 BMS controls the charging current/charging voltage or discharge current/discharge cut-off voltage of the PCS through CAN communication according to the battery voltage and battery temperature.
- 2、 If the battery capacity is less than 8%, BMS controls the PCS to make compulsory recharge through the CAN communication to avoid the damage of the battery due to deep discharge.
- 3、 If SOC was less than 97% for one consecutive month, BMS controlled PCS by CAN communication to full charge the battery to corrected SOC and fully charged capacity.

Note: Through the Sofar Solar PCS, skilled peoples can set the fully charged time period.

PIN	Definition
Pin 1、Pin 8	RS485-B (to PCS, reserved)
Pin 2、Pin 7	RS485-A (to PCS, reserved)
Pin 3	NC
Pin 4	CANH (to PCS)
Pin 5	CANL (to PCS)
Pin6	GND

4.3.4 RS232 Port

RS232 Communication Terminal(RJ45 port) follow RS232 protocol, for manufacturer or professional engineer to debug or service.

PIN	Definition
Pin 8、Pin 1	GND
Pin 2、Pin 7	RS232_TX
Pin 3、Pin 6	RS232_RX
Pin 4、Pin 5	NC

5 Installation Guide

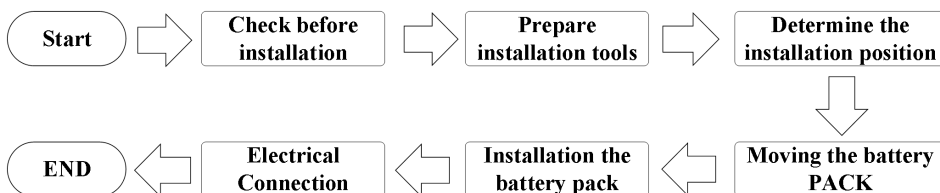

Installation flow chart

5.1 Checking Before Installation

5.1.1 Checking Outer Packing Materials

Packing materials and components may be damaged during transportation. Therefore, check the outer packing materials before installing the battery. Checking the surface of packing materials for damage, such as holes and cracks. If any damage is found, do not unpack the battery and contact the dealer as soon as possible. You are advised to remove the packing materials within 24 hours before installing the battery.









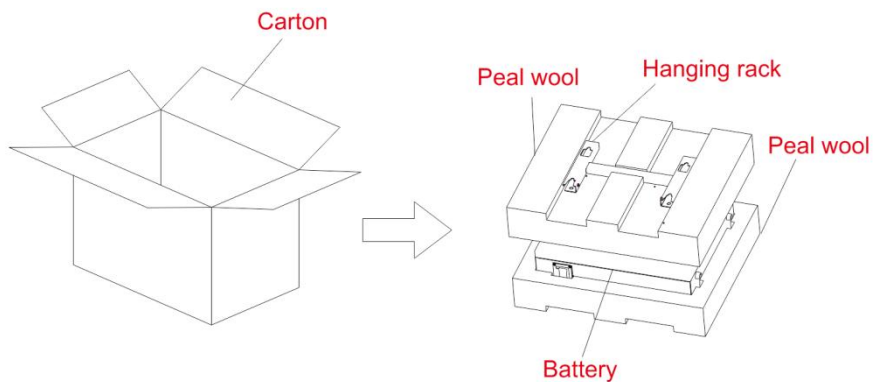

5.1.2 Checking Deliverables

After unpacking the battery , check whether deliverables are intact and complete.

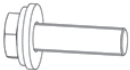



If any damage is found or any component is missed, contact the dealer.

The below table shows the components and mechanical parts that should be delivered.

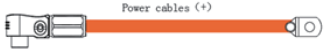
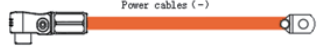

NO.	Pictures	Quantity	Description
1		1PCS	Battery
2		1PCS	Hanging rack
3		4PCS	Fixed leg
4		1PCS	M6*12
5		1PCS	M6*60
6		4PCS	M10*60 Expansion bolts
7		4PCS	M6*16
8		1PCS	Manual
9		1PCS	Test report
10		1PCS	Certificate

The following accessories are configured according to the number of parallel machines in the battery system. For example:

NO.	Pictures	Quantity	Description
1		N-1 ***	Parallel connections cable (P+)
2		N-1 ***	Parallel connections cable *** (P-)
3		N-1 ***	Parallel communication cable ***
4		1pcs	Output Power cables (P+)
5		1pcs	Output Power cables (P-)
6		1pcs	Output communication cable

Note:

1. The standard output power cable is optional accessories component part, the customer can be according to the actual installation requirements customize the output power cable from SofarSolar when the product sold in local or importers provide.
2. *** N is indicate the parallel connections number of battery. The number of power cable and Communication cable is optional accessories according to the parallel connection demand for customer.
3. you are advise use the provide standard accessories part from SofarSolar or customize the identical specification accessories component part from SofarSolar or importers.

Power cable terminal making instructions:

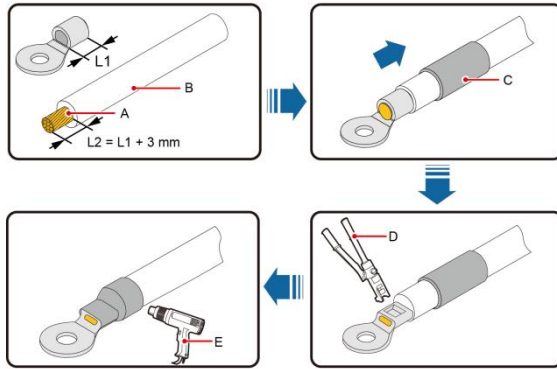



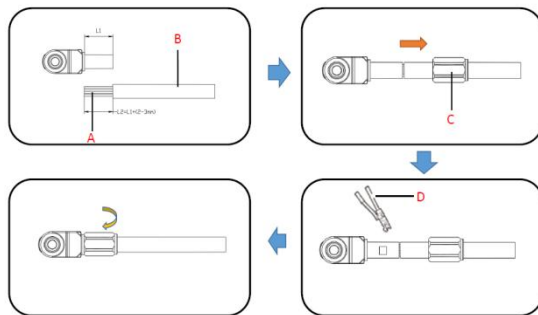





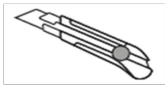

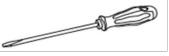

- (A) Core wire (B) Insulation layer (C) Heat shrink tubing
 (D) Hydraulic pliers (E) Heat gun



- (A) Core wire (B) Insulation layer (C) Protective cover
 (D) Hydraulic pliers

5.2 Tools

Model	Tools		
Installation	Knife 	Hammer drill (12mm) 	Socket wrench (10/16mm) 
	Rubber mallet 	Cross Screwdriver 	Marker 
	Incinometer 	Measuring tape 	
Protection	ESD gloves 	Safety goggles 	Anti-dust respirator 
	Safety shoes 		

5.3 Installation Requirements

5.3.1 Installation Environment Requirements

- Install the battery in the indoor environment.
- Place battery in secure location away from children and animals.

- Do not place the battery near any heat sources and avoid sparks.
- Do not expose the battery to moisture or liquids.
- Do not expose the battery to direct sunlight.

5.3.2 Installation Carrier Requirements

- The mounting carrier shall have fire resistance. Do not install batteries on flammable buildings.
- The mounting carrier surface shall meet the load bearing requirements.



5.4 Installation Instructions

5.4.1 Dimensions

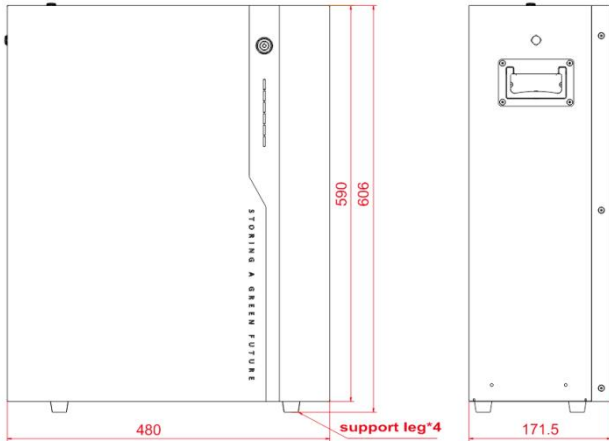

Battery size

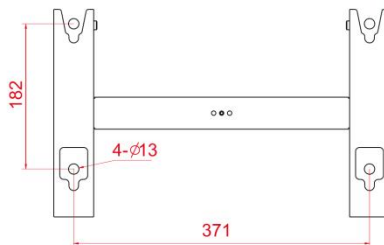

Hanging rack size

Minimum mounting distance between battery pack and other equipment:

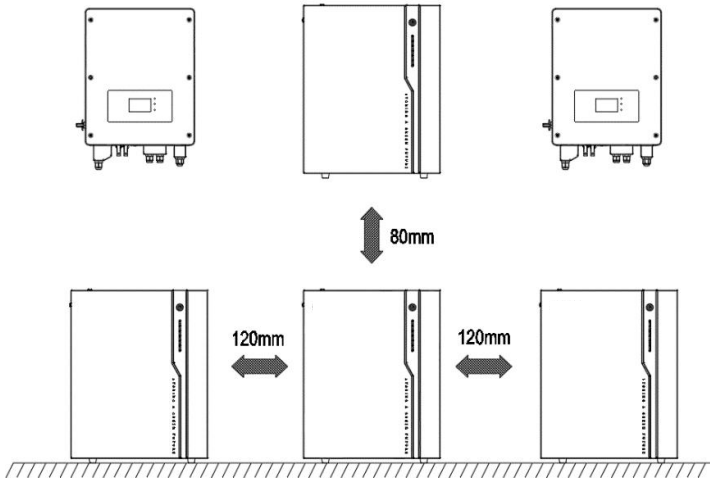
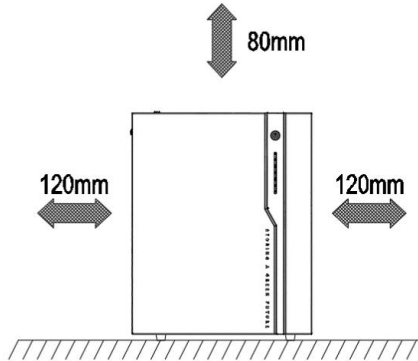

5.4.2 Installation Step

5.4.2.1 Single Machine installation step for suspended on wall

Step 1

To determine the position for drilling holes, and then mark the hole position by using a marker, use the hammer drill to drill hole on the wall. Keeping the hammer perpendicular to the wall, do not shake when drilling, so as not to damage the walls. If the aperture errors, need to reposition.

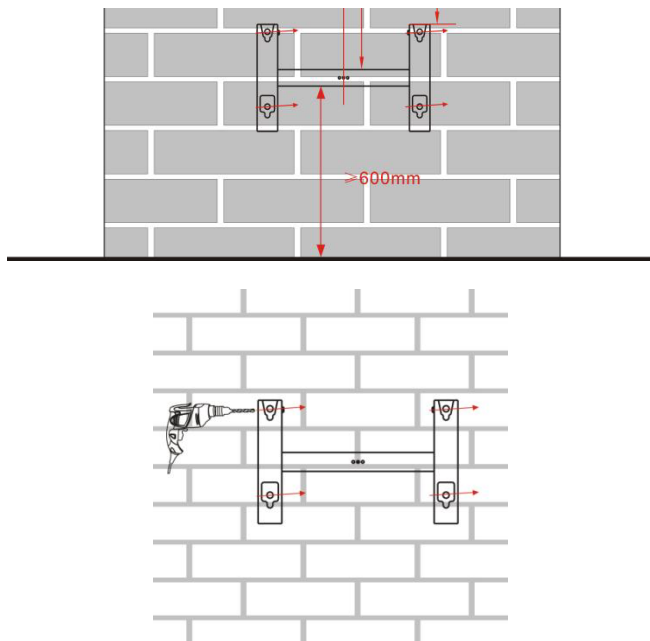

Step 2

Fix the wall hanger with expansion screws.

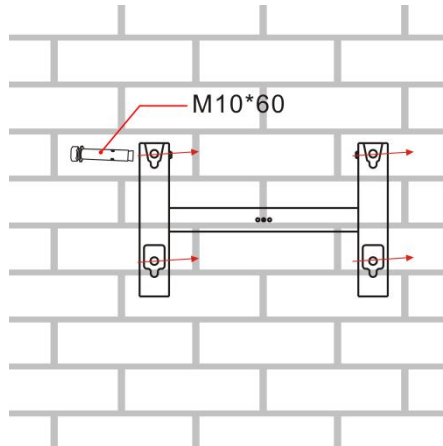

Step 3

Remove the battery and install the fixed leg.

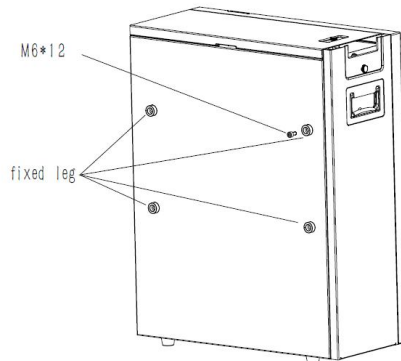

Step 4

Putting the battery hook on the hanging rack.

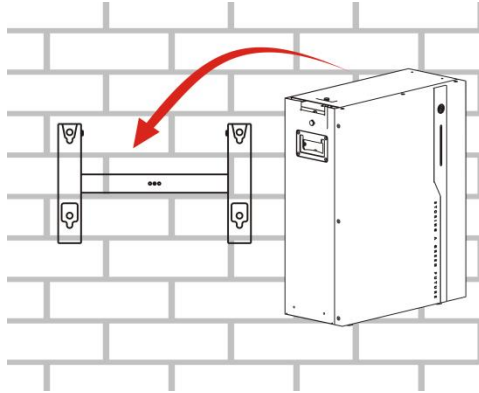

Step 5

Fix the fixing screw (left side or right side) to ensure the safety.



5.5 Electrical Connection

5.5.1 Electrical Connection Process

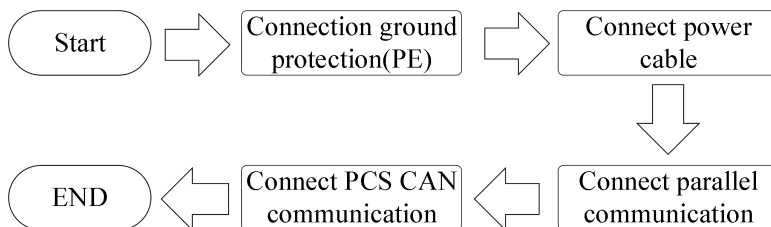

5.5.2 Wiring Step

Step 1

Remove the cover of the terminal.

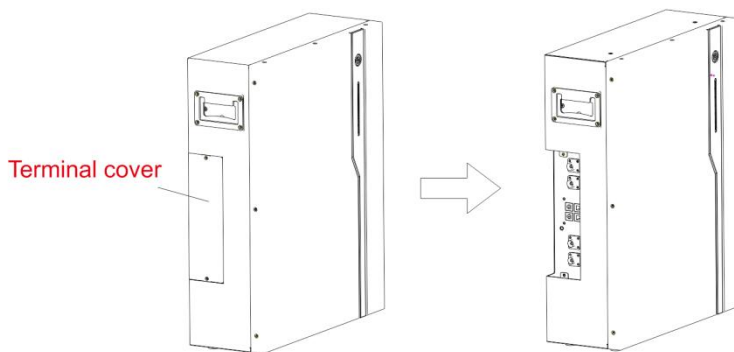

Step 2

Connect PE line.

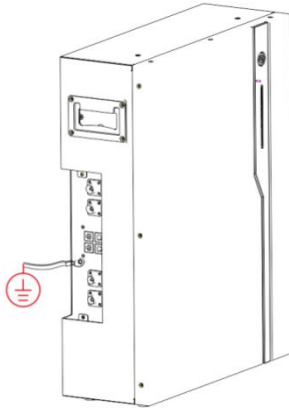
**Step 3**

Connect Power Cable from battery to isolation device.

To isolation device

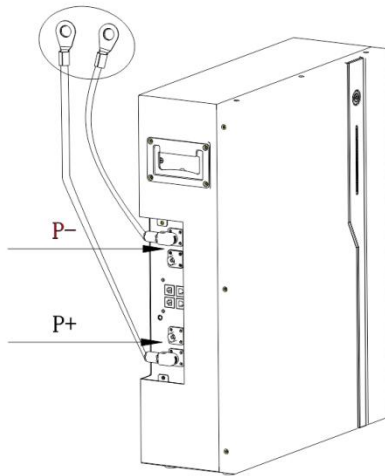

Step 4

Connect CAN communication line to communication port.

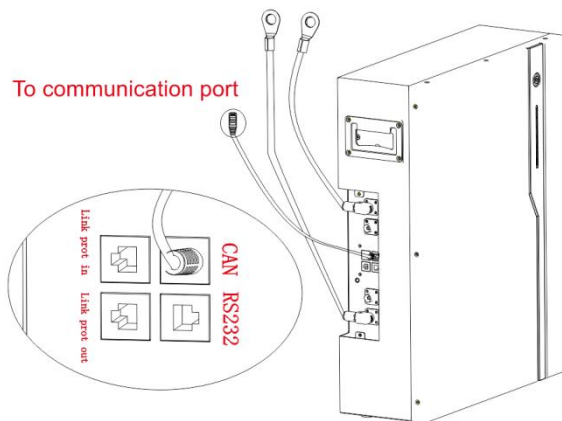

Step 5

Install the terminal cover.

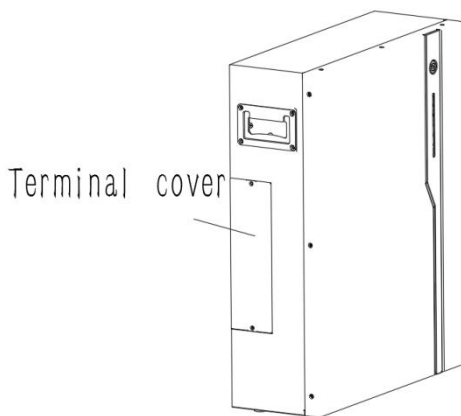

5.5.3 Parallel System Wiring Step

Step 1

Select a suitable location to install the battery system.

Step 2

Connect cables as follows.

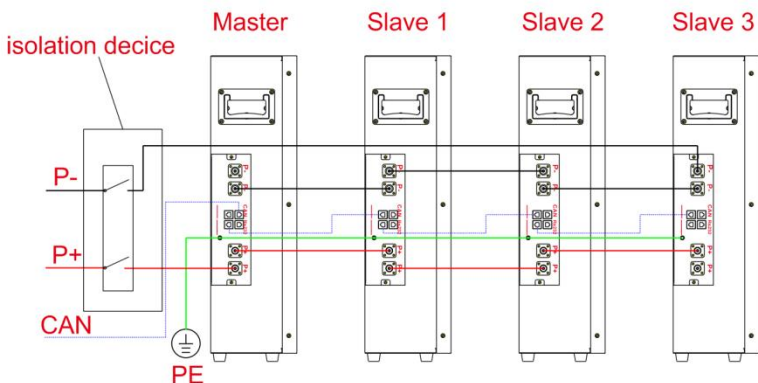

Step 3

Long press the start button of the Master PACK to start the battery system.

6 Cleaning and Maintenance

6.1 Cleaning

CAUTION:

Please power off the system before cleaning.

It is recommended that the SOFAR GTX5000-PRO should be cleaned periodically.

If the enclosure is dirty, please use a soft, dry brush or a dust collector to remove the dust. Liquids such as solvents, abrasives or corrosive liquids should not be used to clean the enclosure.

6.2 Maintenance

6.2.1 Recharge Requirements During Normal Storage

Batteries should be stored in an environment with a temperature range between $-10^{\circ}\text{C} \sim +45^{\circ}\text{C}$, and maintained regularly according to the following table with 0.5C (50A) current until 40% SOC after a long time of storage.

Recharge conditions when in storage

Storage Environment Temperature	Relative Humidity of Storage Environment	Storage Time	SOC
Below -10℃	/	prohibit	/
-10~25℃	5%~70%	≤12 months	30%≤SOC≤60%
25~35℃	5%~70%	≤6 months	30%≤SOC≤60%
35~45℃	5%~70%	≤3 months	30%≤SOC≤60%
Above 45℃	/	prohibit	/

6.2.2 Recharge Requirements When Over Discharged

Please recharge the over discharged (90%DOD) batteries in a timeframe that is in accordance to the following table, otherwise the over discharged battery modules will be damaged.

Recharge conditions when battery is over discharged

Storage Environment Temperature	Storage Time	Note
-10~25℃	≤15 days	Battery Pack disconnect to PCS
25~45℃	≤7 days	
-10~45℃	< 12 hours	Battery Pack connect to PCS

6.2.3 Replacement or Expand capacity

The maintenance of batteries requires a person with professional skills.

- 1、 Before replacement or expand capacity, please cut off the whole system, include PCS and Battery system; at the same time, PCS is disconnected from the power grid;
- 2、 After PCS is confirmed to be disconnected from the power grid, turn off the battery power supply and disconnect the connection line between the battery and PCS.
- 3、 Remove or install new battery refer to section 5.5, and then restart refer to section 4.2.1.

6.2.4 Emergency

Please cut off the power supply and turn off the battery in an emergency.

1) Wet Batteries

If the battery pack is wet or submerged in water, do not let people access it, and then contact Sofar or an authorized dealer for technical support.

2) Fire

NO WATER! Only dry powder fire extinguisher can be used; if possible, move the

battery pack to a safe area before it catches fire.

3) Leaking Batteries

If the battery pack leaks electrolyte, avoid contact with the leaking liquid or gas. If someone is exposed to the leaked substance, immediately perform the actions described below.

Inhalation: Evacuate the contaminated area, and seek medical attention.

Contact with eyes: Rinse eyes with flowing water for 15 minutes, and seek medical attention.

Contact with skin: Wash the affected area thoroughly with soap and water, and seek medical attention.

Ingestion: Induce vomiting, and seek medical attention.

4) Damaged Batteries

Damaged batteries are dangerous and must be handled with the utmost care. They are not fit for use and may pose a danger to people or property. If the battery pack seems to be damaged, pack it in its original container, and then return it to Sofar or an authorized dealer.

7 Technical data

Model	GTX5000-PRO
System Parameters	
Battery type	LFP
Total energy	5120Wh
Usable energy	4600Wh
Rated voltage	51.2V
Operating voltage range	45.6V~56.16V
Rated charging/discharging power	2560W
Rated charging/discharging current	50A
Max.charging/discharging current	50A
Max.Parallel Quantity	4pcs
General Parameters	
Communication	CAN/RS485/RS232

Dimension (W*H*D)	480*606*171.5mm
Weight	47 kg
Protection rating	IP20
Cooling	Natural
Operating temperature	Charge: 0°C ~ +55°C / Discharge: -20°C ~ +60°C
Humidity	5%~95%
Installation	Wall Mounted / Floor Stand
Max.operating altitude	2000 m
Standard	
	UN38.3, IEC62619, IEC62040-1, SAA etc

Note: Operating current derating according to cell voltage and battery temperature.

Version 2.0—February 2023



ENERGY TO POWER YOUR LIFE

ADDRESS

11/F., Gaoxinqi Technology Building,
Xingdong Community, Xin'an Sub-district,
Bao'an District, Shenzhen City, China

EMAIL

info@sofarsolar.com

WEBSITE

www.sofarsolar.com



3 01.00000253-2