



PYLONTECH

Rechargeable Li-ion Battery

US5000 series Operation Manual











Information Version: PM0MUS500255
SD21US501001

This manual introduces US5000 from Pylontech (unless otherwise indicated, all US5000 information are applied to US5000-B). Please read this manual before using and follow the instruction carefully during the installation process. Any confusion, please contact Pylontech for advice and clarification.

1. Symbol	1
2. Safety Precautions	3
2.1 Before Connecting	4
2.2 In Using	4
3. Introduction	5
3.1 Features	5
3.2 Specification	7
3.3 Equipment interface instruction	8
Definition of RJ45 Port Pin	12
4. Safe handling of lithium batteries guide	14
4.1 Schematic diagram of solution	14
4.2 Danger label	14
4.3 Tools	15
4.4 Safety gear	15
5. Installation and operation	16
5.1 Package items	16
5.2 Installation location	18
5.3 Installation Direction	19
5.4 Grounding	20
5.5 Put into cabinet or rack	21
5.6 Put into bracket	22
5.7 Suitable disconnection device	23
5.8 Power on	24
5.9 Power off	25
5.10 Multi-group mode	26
6. Trouble shooting	28
7. Emergency Situations	31
8. Remarks	32

1. Symbol

	Caution! Warning! Reminding. Safety related information. Risk of battery system failure or life cycle reduces.
	Do not reverse connect the positive and negative port.
	Do not place near open flame.
	Do not place at the children or pet touchable area.
	Warning electric shock.
	Warning Fire. Do not place near flammable material
	Read the product and operation manual before operating the battery system!
	Grounding.
	Recycle label.

	<p>The certificate label for EMC/CE.</p>
	<p>The certificate label for UKCA.</p>
	<p>The certificate label for Safety by TÜV Rheinland.</p>
	<p>The certificate label for Safety by TÜV SÜD.</p>
	<p>The certificate label for Safety by CSA.</p>
	<p>Label for Waste Electrical and Electronic Equipment (WEEE) Directive (2012/19/EU)</p>

2. Safety Precautions



Reminding

- 1) It is important and necessary to read the user manual carefully before installing or using battery. Failure to do so or to follow any of the instructions or warnings in this document can result in electrical shock, serious injury, or death, or can damage battery, potentially rendering it inoperable.
- 2) If the battery is stored for long time, it is required to charge every six months, and the SOC should be no less than 90%
- 3) Battery needs to be recharged within 12 hours after fully discharged.
- 4) Do not install the product in outdoor environment, or an environment out of the operation temperature or humidity range listed in manual.
- 5) Do not expose cable outside.
- 6) Do not connect power terminal reversely.
- 7) All the power terminals must be disconnected for maintenance.
- 8) Please contact the supplier within 24 hours if there is something abnormal.
- 9) Do not use cleaning solvents to clean battery.
- 10) Do not expose battery to flammable or harsh chemicals or vapors.
- 11) Do not paint any part of battery, include any internal or external components.
- 12) Do not connect battery with PV solar wiring directly.
- 13) Any foreign object is prohibited to insert into any part of battery.
- 14) The warranty claims are excluded for direct or indirect damage due to items above.

2.1 Before Connecting



Warning

- 1) After unpacking, please check product and packing list first, if product is damaged or lack of parts, please contact with the local retailer.
- 2) Before installation, be sure to cut off the grid power and make sure the battery is in the turned-off mode.
- 3) Wiring must be correct, do not mistake the positive and negative cables, and ensure no short circuit with the external device.
- 4) It is prohibited to connect the battery and AC power directly.
- 5) The embedded BMS in the battery is designed for 48VDC, please DO NOT connect battery in series.
- 6) Battery must connect to ground and the resistance must be less than 0.1Ω .
- 7) Please ensured the electrical parameters of battery system are compatible to related equipment.
- 8) Keep the battery away from water and fire.

2.2 In Using

- 1) If the battery system needs to be moved or repaired, the power must be cut off and the battery is completely shut down.
- 2) It is prohibited to connect the battery with different type of battery.
- 3) It is prohibited to connect batteries with faulty or incompatible inverter
- 4) It is prohibited to disassemble the battery (QC tab removed or damaged).
- 5) In case of fire, dry powder fire extinguisher or vast amount of water can be used.
- 6) Please do not open, repair or disassemble the battery except staffs from Pylontech or authorized by Pylontech. We do not undertake any consequences or related responsibility which because of violation of safety operation or violating of design, production and equipment safety standards.

3. Introduction

US5000 lithium iron phosphate battery is the new energy storage products developed and produced by Pylontech, it can be used to support reliable high power for various types of equipment and systems.

3.1 Features

- 1) Build-in soft-start function able to reduce current strike when inverter need to start from battery.
- 2) Dual active protection on BMS level.
- 3) Automatic address setting when connect in multi-group.
- 4) Support wakeup by 5~12V signal from RJ45 port.
- 5) Support upgrade battery module from upper controller via CAN or RS485 communication.
- 6) Enable 95% depth of discharge, available for the inverter which completely follow Pylontech latest protocol to operate.
- 7) The module is non-toxic, non-pollution and environmentally friendly.
- 8) Cathode material is made from LiFePO₄ with safety performance and long cycle life.
- 9) Battery management system (BMS) has protection functions including over-discharge, over-charge, over-current and high/low temperature.
- 10) The system can automatically manage charge and discharge state and balance voltage of each cell.
- 11) Flexible configuration, multiple battery modules can be in parallel for expanding capacity and power.
- 12) Adopted self-cooling mode rapidly reduced system entire noise.
- 13) The module has less self-discharge, up to 6 months without charging it on shelf, no memory effect, excellent performance of shallow charge and discharge.

- 14) Small size and light weight, standard of 19-inch embedded designed module is comfortable for installation and maintenance.
- 15) Compatible with the 48V series battery of Pylontech.

*Mixture using master battery priority:

US5000>UP5000/US3000C/US2000C>U3000/US2000

For same type of module always use the latest production unit as master.

*Mixture using battery deployment option:

Master battery (1 st)	US5000
Slave 2 nd ~8 th	US5000/UP5000/US3000C/US2000C/ US3000/US2000
Slave 9 th ~16 th	US5000/UP5000/US3000C/US2000C

3.2 Specification

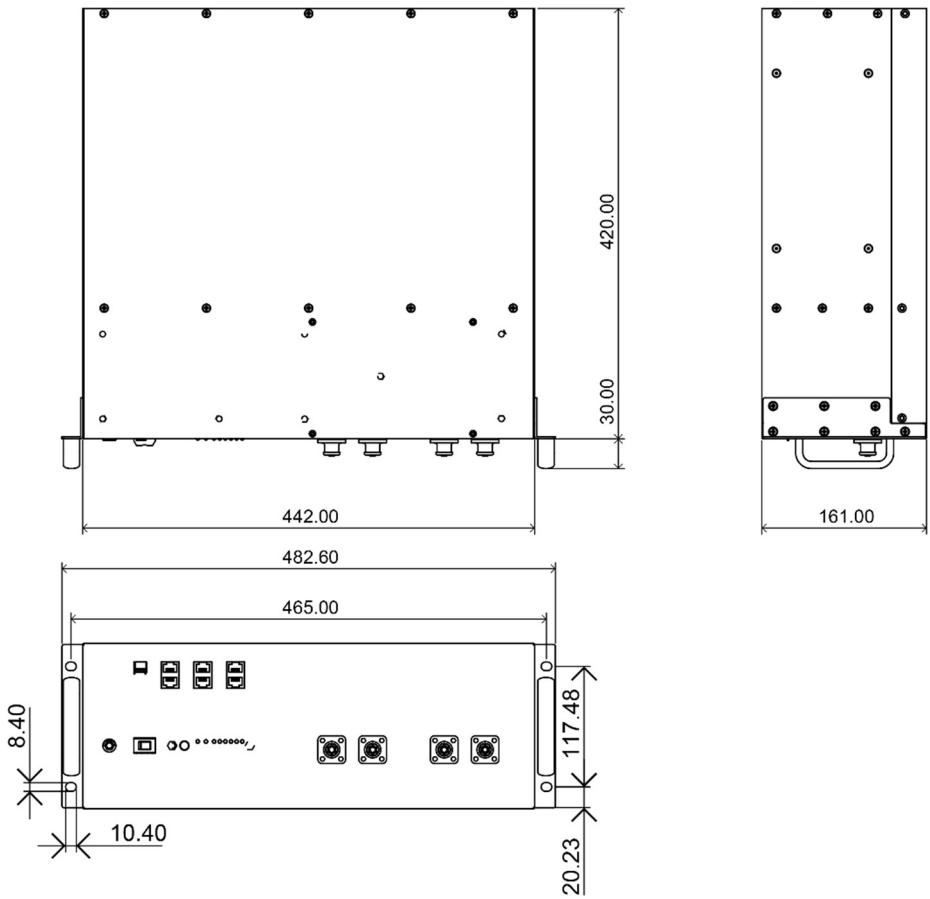

Basic Parameters	US5000	US5000-B
Nominal Voltage (Vdc)	48	
Nominal Capacity (Wh)	4800	
Usable Capacity (Wh)	4560	
Depth of discharge (%)	95	
Dimension (mm)	442*420*161	
Weight (Kg)	39.7	40
Discharge Voltage (Vdc)	43.5 ~ 53.5	
Charge Voltage (Vdc)	52.5 ~ 53.5	
Recommended Charge/Discharge Current (A)	80*	
Max. continuous Charge/Discharge Current (A)	100*	
Peak Charge/Discharge Current (A)	101-120@15min	
	121~200@15sec	
Communication	RS485, CAN	
Configuration (max. in 1 battery group)	16pcs	
Working Temperature	0°C ~50°C Charge	
	-10°C ~50°C Discharge	
Shelf Temperature	-20°C ~45°C	
Short current/duration time	<2000A/1ms	
Cooling type	Natural	
Breaker	No	Yes
Protective class	I	
IP rating of enclosure	IP20	
Humidity	5% ~ 95%(RH) No Condensation	
Altitude(m)	≤4000	
Certification	TÜV / CE / UL / UN38.3	
Design life	15+ Years (25°C /77°F)	
Cycle Life	>6,000 25°C	
Reference standards	IEC62619, IEC63056, UL1973, UL9540A, IEC61000-6-2, IEC61000-6-3, UN38.3	

*: The recommended and max. continuous operation current is for a battery cell temperature within 10~40°C to consider, out of such temp. range will cause a derating on operation current.

3.3 Equipment interface instruction

US5000 front panel

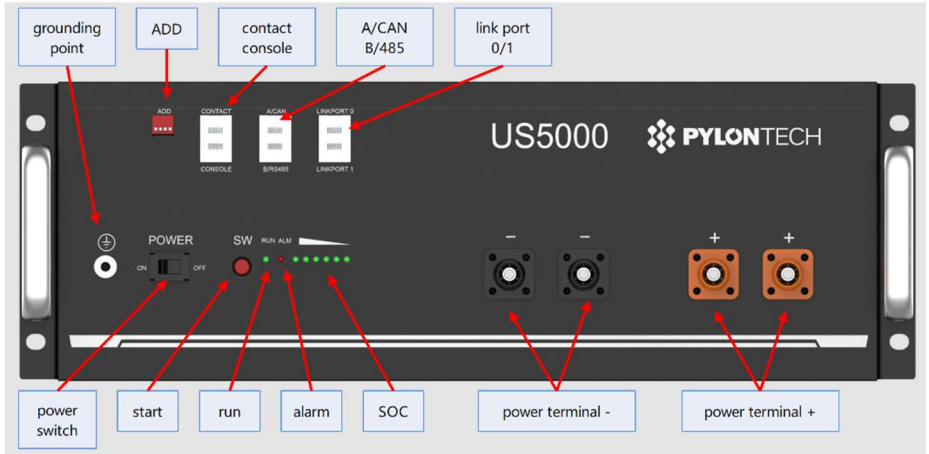

US5000-B front panel

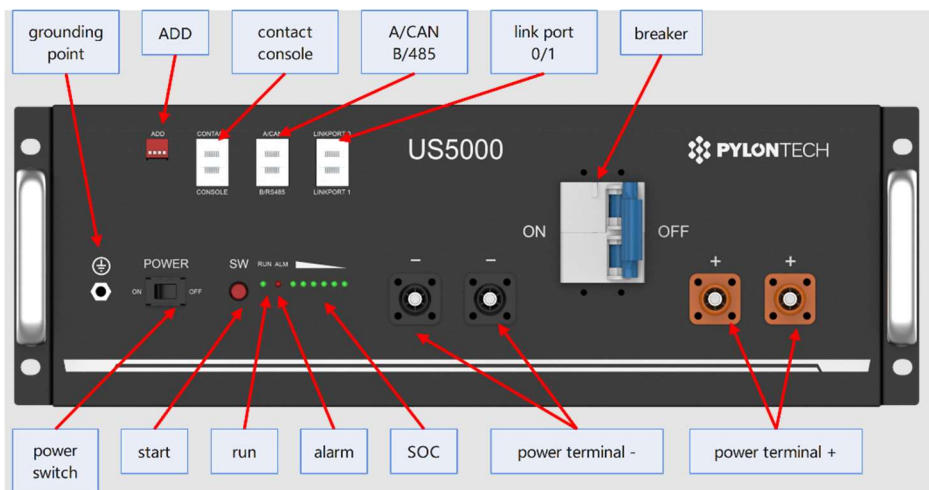

Breaker (for US5000-B)

Parameter: type C, rated voltage 60V/DC, rated current 125A, Icu: 10kA.
Standard reference: UL1077, IEC60947-2.

ON: power terminals connect with battery.

OFF: power terminals disconnect with battery.



Reminding

When breaker released for protection, check the root cause of current surge and cable connection between battery and inverter first. Then try to connect again.

Power Switch

ON: ready to turn on.

OFF: power off. For storage or shipping.

Start (SW)

Turn on: press more than 0.5s to start the battery.

Turn off: press more than 0.5s to turn off the battery.

RUN

Green LED flashing or lighting to show the battery running status.

Alarm (ALM)

Red LED flashing to show the battery has alarm; lighting to show the battery is under protection.

SOC

LEDs to show the battery's current capacity.

Dip Switch (ADD)



Dip1: RS485 baud rate: 1: 9600; 0: 115200. After change, please restart battery.

Dip2: CAN terminal resistance on BMS side. 1: NONE. 0: connected. After change, no restart required. **In single group mode, please keep dip2 at 0 position.** For multi-groups, please refer to [5.10].

Dip3~4, reversed.

Based on design of BMS, the dip switch is deployed physically reversely.

For instance:

Dip1	Dip2	Dip3	Dip4	The corresponding position of switch	Status
0	0	0	0		RS485:115200 CAN terminal resistance: connected
1	0	0	0		RS485:9600 CAN terminal resistance: connected
0	1	0	0		RS485: 115200 CAN terminal resistance: disconnected.

Console

For manufacturer or professional engineer to debug or service.

Pin3	232-TX
Pin4*	+5~+12V for wake up
Pin5*	GND for wake up
Pin6	232-RX
Pin8	232-GND
*Wake up signal shall $\geq 0.5\text{Sec}$, current between 5~15mA. After send wake up signal, the voltage shall disappear for normal operation.	

Contact

Pin1	Input, passive signal. On: turn off battery. Off: normal.	
Pin2		
Pin3	Output1. On: stop charge.	+
Pin4		-
Pin5	Output2. On: stop discharge.	+
Pin6		-
Pin7	Output3. On: BMS error.	+
Pin8		-

Input terminals: BMS provide 5Vdc internally. External contactor control ON/OFF.

Output terminals: BMS control ON/OFF. External source request signal voltage $\leq 25\text{V}$, current $< 0.3\text{A}$.

CAN

500 Kbps. Recommended 120Ω. To inverter or upper battery.

RS485

9600 or 115200 bps. Recommended 120Ω. To inverter or slave battery.

Link Port 0, 1

For communication between multiple parallel batteries.

Definition of RJ45 Port Pin

	A/CAN	B/RS485
Pin1	These pins shall be NULL.	
Pin2	If not, may influence communication between BMS and inverter.	
Pin3		
Pin4	CAN-H	CAN-H
Pin5	CAH-L	CAN-L
Pin6	CAN-GND	CAN-GND
Pin7	485A	485A
Pin8	485B	485B

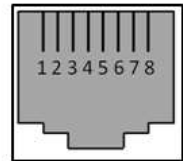

RJ45 Port



RJ45 Plug

Power Terminals

Power cable terminals: there are two pair of terminals with same function, one connects to equipment, the other one paralleling to other battery module for capacity expanding.

For power cables uses self-locked connectors. must keep pressing this Lock Button while pulling out the power plug.

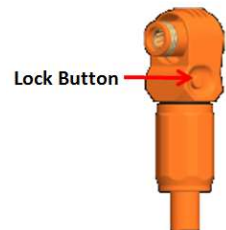

LED Status Indicators

Condition	RUN	ALR	1	2	3	4	5	6
Power off	-	-	-	-	-	-	-	-
Power on								
Idle/Normal		-	-	-	-	-	-	-
Charge		-	Show soc; highest LED flash, on 0.5s, off 0.5s					
Discharge			Show soc					
Alarm	ALR: Other LEDs are same as above.							
System error/Protect	-		-	-	-	-	-	
	ON							
	flash, on: 0.3s; off: 3.7s							
	flash, on:0.5s; off: 1.5s							
SOC level (%)			91-100	70-90	51-70	31-50	11-30	0~10

BMS basic function

Protection and alarm	Management and monitor
Charge/Discharge End	Cells Balance
Charge Over Voltage	Intelligent Charge Model
Discharge Under Voltage	Charge/Discharge Current Limit
Charge/Discharge Over Current	Capacity Retention Calculate
High/Low Temperature(cell/BMS)	Administrator Monitor
Short Circuit	Operation Record
	Power Cable Reverse
	Soft start of inverter

4. Safe handling of lithium batteries guide

4.1 Schematic diagram of solution

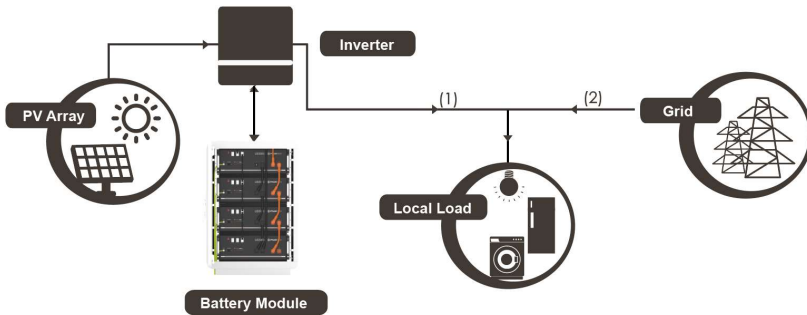

4.2 Label

! DANGER

**DANGER LOW DC VOLTAGE INSIDE
DANGER ARC FLASH & SHOCK HAZARD**

- * Do not disconnect or disassemble by non-professional personnel.
- * Do not drop, deform, impact, cut or spearing with a sharp object.
- * Do not place at a children or pet touchable area.
- * Do not place near open flame or flammable material.
- * Do not cover or wrap the product case.
- * Do not sit or put heavy things on battery.
- * Do not touch the leaking liquid.
- * Avoid of direct sunlight.
- * Avoid of moisture or liquid.
- * Make sure the grounding connection set correctly before operation.
- * If leaking, fire, wet or damaged, switch off the breaker on DC side and stay away from battery.
- * Contact your supplier within 24 hours if anything failure happens.



4.3 Tools



Wire cutter



Crimping modular plier



Screwdriver

NOTE

Use properly insulated tools to prevent accidental electric shock or short circuits.

If insulated tools are not available, cover the entire exposed metal surfaces of the available tools, except their tips, with electrical tape.

4.4 Safety gear

It is recommended to wear the following safety gear when dealing with the battery.



Insulated gloves



Safety goggles



Safety shoes

5. Installation and operation

5.1 Package Items

Unpacking and check:

1) **For battery module package:**

- Battery Module
- 2 * 210mm 4AWG power cables
- 1 * 210mm RJ45 communication cable
- 1 * 1000mm 6AWG grounding cable

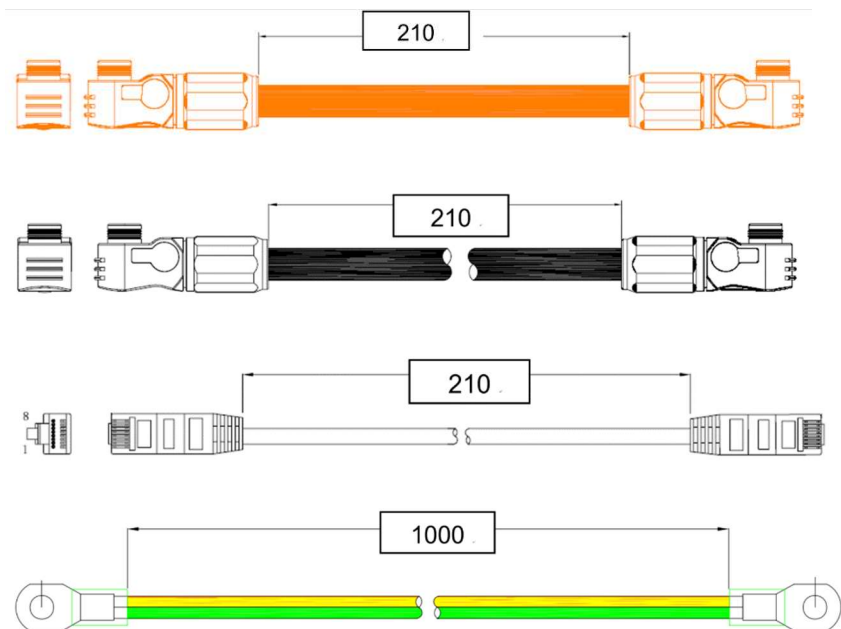

2) For External cable kits:

NOTE: Power and communication cables connect to inverter belongs to an **External Cable Kit, NOT include in battery carton box**. They are in another **extra** small cable box. If there is anything missed, please contact dealer.

- 2 * 2000mm power cables (4 AWG, peak current capacity **120A**, constant **100A**) and communication cable for each energy storage system.
- 2 * 3000mm RJ45 communication cable, specification as below:

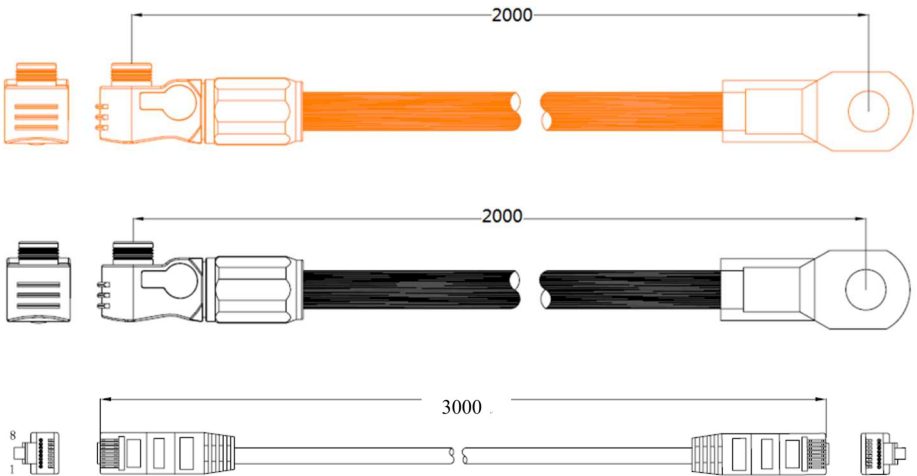

SN of RJ45cable	Mark	Pin	
WI0SCAN30RJ1	With blue mark: Battery-Inverter	1~3: NULL 4~8: pin to pin	For connection to inverter and HUB
WI0SCAN35RJ3	With silver mark: Battery-Battery	1~8: pin to pin	For parallel connection between master batteries

For the external cables, the length shall less than 3 meters.

5.2 Installation location

Make sure that the installation location meets the following conditions:

- 1) The area is completely waterproof.
- 2) The floor is flat and level.
- 3) There are no flammable or explosive materials.
- 4) The ambient temperature is within the range from 0°C to 50°C.
- 5) The temperature and humidity are maintained at a constant level.
- 6) There is minimal dust and dirt in the area.
- 7) The distance from heat source is more than 2 meters.
- 8) The distance from air outlet of inverter is more than 0.5 meters.
- 9) The installation areas shall avoid of direct sunlight.
- 10) There is no mandatory ventilation requirements for battery module, but please avoid of installation in confined area. The aeration shall avoid of high salinity, humidity or temperature.



Caution



If the ambient temperature is out of the operating range, the battery stops operating to protect itself. The optimal temperature range for the battery pack to operate is 10°C to 40°C. Frequent exposure to harsh temperatures may deteriorate the performance and life of the battery.

5.3 Installation Direction

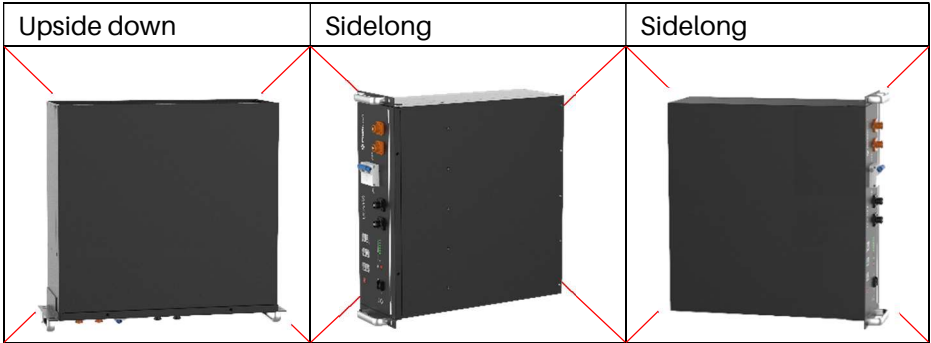
NOT allowed:

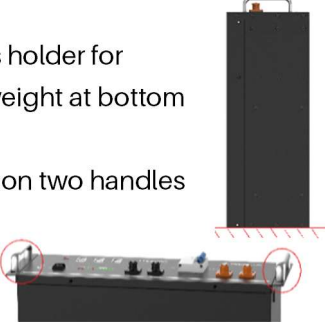

Recommended:

		Note
A		<p>Caution: Do not stack modules together directly.</p> 
B		<p>Caution: Make sure there is holder for more than 40kg weight at bottom of each module. Installed only rely on two handles is NOT allowed.</p> 

5.4 Grounding

Grounding cables shall be 6AWG or higher yellow-green cables. After connection, the resistance from battery grounding point to Ground connection point of room or installed place shall smaller than 0.1 Ω .

- 1) based on metal directly touch between the module's surface and rack's surface. If using painted rack, the corresponding place shall remove the painting.



- 2) install a grounding cable to the grounding point of the modules.



5.5 Put into cabinet or rack

Put battery modules into cabinet and connect the cables:



- 1) Put the battery into the cabinet.
- 2) Drive the 4 pcs screws.
- 3) Connect the cables between battery modules.
- 4) Connect the cables to inverter.

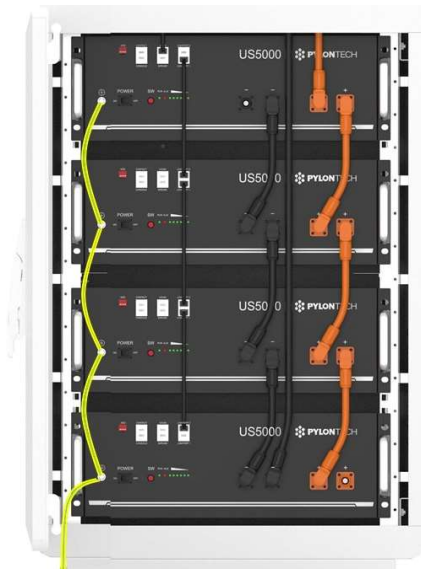

5.6 Put into bracket

- 1) Put the battery into 2 pcs of bracket.



- 2) Use 4 location holes, stack the batteries together. And connect the 4 locker together.

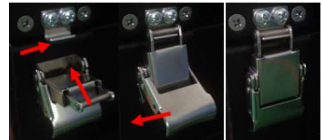

- 3) Maximum 3 in stack.



NOTE

After installation, do not forget to register online for full warranty:

<http://www.pylontech.com.cn/service/support>



Caution

- 1) follow local electric safety and installation policy, a suitable disconnection device between battery system and inverter could be required.
- 2) all the installation and operation must follow local electric standard.

5.7 Suitable disconnection device

It is recommended to have a disconnection device for protection between battery system and inverter:

- 1) The rated voltage shall $\geq 60V$ DC. Do **NOT** use AC breaker.
- 2) The rated current shall match with system design:
shall consider:
 - the maximum DC current on inverter side.
 - the number of power cable: for instance, if only one pair of 4awg cable, the rated current of breaker shall be 125A or smaller.
- 3) If using breaker, the type shall be type C (recommended) or type D.

The Icu required:

the maximum short circuit current for calculation of each module is 2500A.
for instance:

	Icu of breaker
1~4 modules	Must $\geq 10kA$
5~8 modules	Must $\geq 20kA$

5.8 Power on

Double check all the power cable and communication cable between batteries and between battery and inverter. Switch ON the disconnection device between battery and inverter if available. **When adding a US5000 battery to your existing system, it is essential to allow the batteries to run without solar input to ensure proper balancing. Alternatively, if your battery bank is fully charged, it is recommended to wait until it reaches 3 to 4 LED indicators of charge before adding new batteries.**

For US5000-B:

Switch ON all modules' breaker first.

For US5000 and US5000-B:

- 1) Switch on all the battery modules:

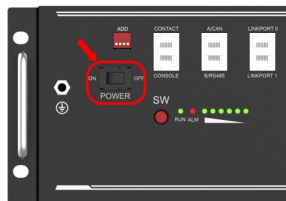

- 2) The one with **empty Link Port 0** is the **Master Battery Module**, others are slaves (1 master battery configure with maximum 15 slave batteries):

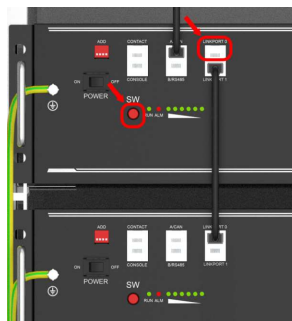

- 3) Press the **red SW button** of **master battery** to power on, all the battery LED light will be on one by one from the Master battery:



Note:

- 1) After the battery module powered on, the soft-start function takes **3sec** to active. After soft-starts battery ready to output high power.
- 2) During capacity expansion or replacement, when parallel different SOC/voltage of module together, it is recommended to maintain the system in idle for ≥ 15 mins or till the SOC LEDs becomes similar (≤ 1 dot difference) before normal operation.

5.9 Power off

- 1) Turn external power source off.
- 2) Press red SW switch of master battery. Then all batteries will off.
- 3) Switch Power switch OFF.
- 4) Switch Breaker OFF (for US5000-B).
- 5) Switch OFF the disconnection device between battery system and inverter, if available.

5.10 Multi-group mode

Connect power cable first:

- 1) each pair of cable hold max 100A constant current. Connect enough pairs of cable based on calculation of system current.
- 2) Suitable protection device between battery system and inverter is required.

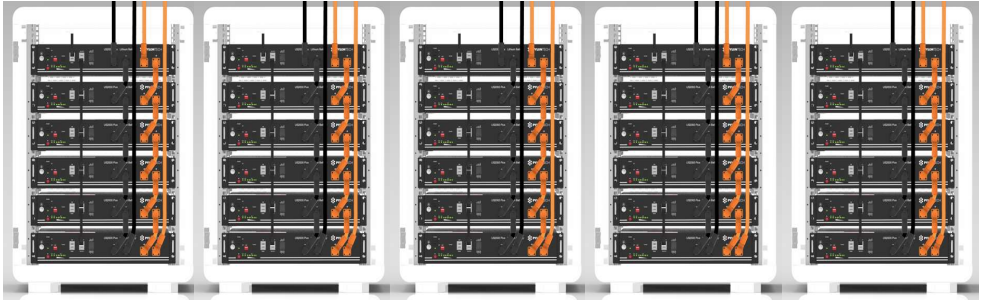

By RS485: DO NOT need LV-HUB.

- 1) Make sure all dip switch of master batteries is R000.
R: is the baud rate of RS485, all master batteries shall be the same.
- 2) Connect communication cable follow the picture:

Multiple Battery Groups RS485 Communication Cable Connection

Max 6 groups

- 1) The A/CAN of 1st group/master battery connects to inverter or EMS(pin: 7A, 8B, **DO NOT connect other pins**)
- 2) The B connect to A of next group; the B/RS485 of last group master battery is empty.

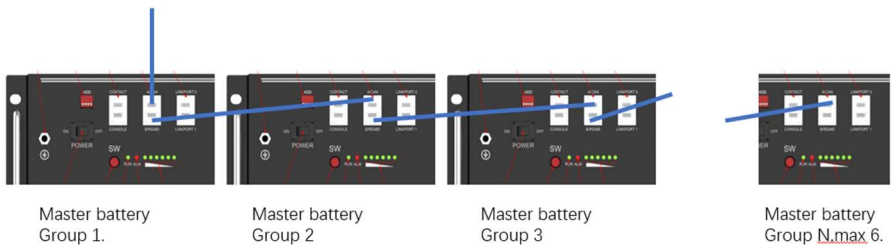

- 3) Then turn ON the batteries. After all batteries running and buzzer of master battery in group1 rings 3 times. Means all groups are online.
For inverter or EMS, The interruption of each RS485 command shall at least $\geq 1s$.

By CAN:

- 1) connect power cable of LV-HUB.
- 2) Connect communication cable follow the picture.
the cable from master battery to LV-HUB, is recommended to use: WIOSCAN30RJ1 or cable with pin 1~3 empty.

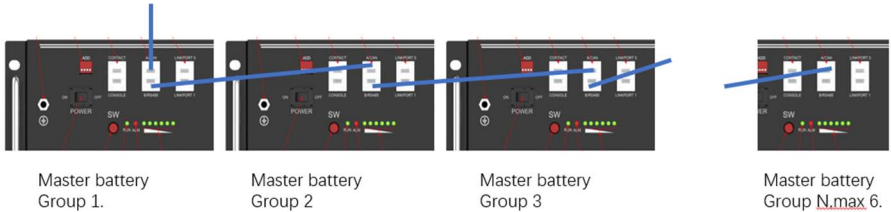

- 3) Make sure all dipswitch of master batteries is 0000, then turn ON batteries.
- 4) After all batteries running and buzzer of master battery in group1 rings 3 times. Means all groups are online.
- 5) Change the dip switch of **master battery in group1** to 0100. Then connect communication cable between LV-HUB and master battery in group 1.
- 6) Then turn ON LV-HUB.

Detailed information please refer to manual of LV-HUB.

Multiple Battery Groups CAN Communication Cable Connection

Each Communication HUB connects maximum 6 battery piles.

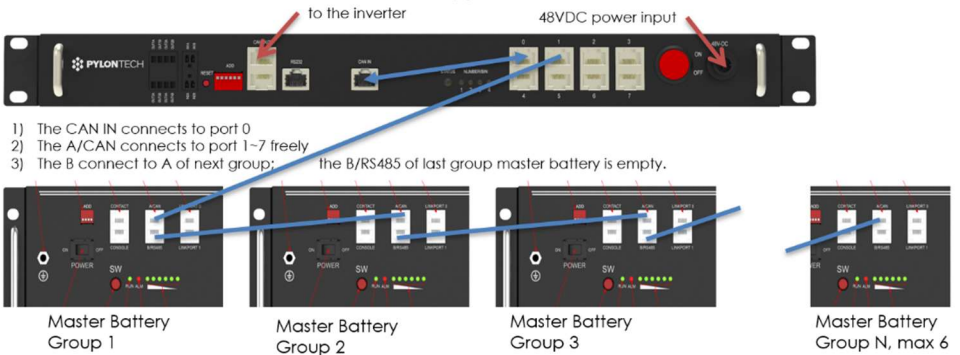

6. Trouble shooting

- Communication related problem

Unable to communicate with inverter on compatible list.

Possible conditions:

- 1) RS485: baud rate. Check the dip switch1, set to correct one, and restart. All master battery shall be the same.
- 2) CAN: terminal resistance. Check the dip switch2, set to 0 and retry.
- 3) CAN: pin. Try connects the CAN-H, L, GND only and do not connect other pins to inverter. Using the correct cable.

- Functional related problem

- 1) Whether the battery can be turned on or not
- 2) If battery is turned on, check the red light is off, flashing or lighting
- 3) If the red light is off, check whether the battery can be charged/discharged or not.

Possible conditions:

- 1) Battery cannot turn on, switch ON and press the red SW the lights are all no lighting or flashing.
- a) Capacity too low, or module over discharged.

solution: use a charge or inverter to provide 48-53.5V voltage. If battery can start, then keep charge the module and use monitor tools to check the battery log.

If battery terminal voltage is $\leq 45\text{Vdc}$, please use $\leq 0.05\text{C}$ to slowly charge the module to avoid affect to SOH. If battery terminal voltage is $> 45\text{Vdc}$, it can use $\leq 0.5\text{C}$ to charge.

If battery cannot start, turn off battery and repair.

- 2) The battery can turn on, but red light is lighting, and cannot charge or discharge. If the red light is lighting, that means system is abnormal, please check values as following
- b) Temperature: Above 60°C or under -10°C , the battery could not work.

Solution: to move battery to the normal operating temperature range between 0°C and 50°C.

- c) Current: If current exceeds 90A, battery protection will turn on.
Solution: Check whether current is too large or not, if it is, change the settings on power supply side.
 - d) High Voltage: If charging voltage above 54V, battery protection will turn on.
Solution: Check whether voltage is too high or not, if it is, to change the settings on power supply side. And discharge the module.
 - e) Low Voltage: When the battery discharges to 44.5V or less, battery protection will turn on.
Solution: Charge the battery till the red light turns off.
 - f) Cell voltage high. The module voltage is lower than 54V, SOC LED does not all on. When discharge the module protection disappear.
Solution: keep charge the module by 53-54V or keep the system cycle. The BMS can balance the cell during cycling.
- 3) Unable to charge and discharge with red LED on. The temperature is 0~50 degree. Use charger to charge, not possible. Use load to discharge, not possible.
- g) Under permanent protection. The single cell voltage has been higher than 4.2 or lower than 1.5 or temperature higher than 80 degree. Solution: Switch off the module and contact your local distributor for repair.
- 4) Unable to charge and discharge without red LED on. The temperature is 0~50 degree. Use charger to charge, not possible. Use load to discharge, not possible.
- h) Fuse broken.
Solution: Switch off the module and contact your local distributor for repair.
- 5) Buzzer rings and **all LED flash**
- i) High voltage protection.
Cell voltage higher than 4V or module voltage higher than 55.5V.
Solution: **Battery system requires properly established communication with inverter and correctly settings on inverter to run safely.** Check the setting of the inverter or charger, the charge voltage shall be 53.2~52.5Vdc;

Check the communication between battery system and inverter whether established or not; Check the ADD switch on battery module whether is set correctly or not;

Under this condition, the BMS remains functional without damage. Just leave the module switched OFF and wait for the battery voltage drop down naturally(15mins) then restart. If then no alarm comes out, this means the module is ready for work.

6) Buzzer rings and **ALM solid red**

j) Reverse connection of cables.

Solution: Power off all battery and inverters. Disconnect breaker. Check the cable connection and disconnect all power cables. Check the power port damaged or not. Then try turn on the single module, without any cable connected. If no alarm, then it is reverse connection of cables. Switch off the module and contact your local distributor.

k) MOSFAIL.

Solution: Power off all battery and inverters. Disconnect breaker. Check the cable connection and disconnect all power cables. Check the power port damaged or not. Check the setting of inverter or charger, check the communication between inverter and battery system.

Try turn on the single module, without any cable connected. If still buzzer rings. Then switch off the module and contact your local distributor.

7) After switch On, the module turns on directly

l) BMS failure.

Solution: Switch off the module and contact your local distributor.

Excluding the points above, if the faulty still cannot be located, turn off battery and contact your local distributor.

7. Emergency Situations

1) Leaking Batteries

If the battery pack leaks electrolyte, avoid contact with the leaking liquid or gas. If one is exposed to the leaked substance, immediately perform the actions described below.

- a) Inhalation: Evacuate the contaminated area and seek medical attention.
- b) Contact with eyes: Rinse eyes with flowing water for 15 minutes and seek medical attention as soon as possible.
- c) Contact with skin: Wash the affected area thoroughly with soap and water and seek medical attention.

Ingestion: Induce vomiting and seek medical attention.

2) Fire

If detect the battery cell is catching fire, firstly cut off the external power source. Then use vast of water for suppression. After fire suppressed, soaking battery within water and contact Pylontech or an authorized dealer. If detect the cabling or other components (not battery cell) is catching fire. Firstly, cut off the external power source. Then use dry powder fire or carbon dioxide extinguisher for suppression.

3) Wet Batteries

If the battery pack is wet or submerged in water, do not let people access it, and then contact Pylontech or an authorized dealer for technical support. Cut off all power switch on inverter side.

4) Damaged Batteries

Damaged batteries are dangerous and must be handled with the utmost care. They are not fit for use and may pose a danger to people or property. If the battery pack seems to be damaged, pack it in its original container, and then return it to Pylontech or an authorized dealer.



Caution

Damaged batteries may leak electrolyte or produce flammable gas.

8. Remarks

Recycle and disposal.

In case a battery (normal condition or damaged) needs disposal or needs recycling, it shall follow the local recycling regulation (i.e. Regulation (EC) N° 1013/2006 among European Union) to process, and using the best available techniques to achieve a relevant recycling efficiency.



Li-ion ████████

Storage, Maintenance and Expansion

- 1) It is required to charge the battery at least once every 6 months, for this charge maintenance make sure the SOC is charged to higher than 90%
- 2) Every year after installation. The connection of power connector, grounding point, power cable and screw are suggested to be checked. Make sure there is no loose, no broken, no corrosion at connection point. Check the installation environment such as dust, water, insect etc. make sure it is suitable for IP20 battery system.
- 3) A new battery module can be added onto an existing system at any time. Please make sure the new battery is acting as the master. The new module, due to a higher SOH may have a difference on SOC with existing system, but it will not affect the parallel connection system performance.



PYLONTECH

Pylon Technologies Co., Ltd.

No. 73, Lane 887, ZuChongzhi Road, Zhangjiang Hi-Tech Park
Pudong, Shanghai 201203, China

T+86-21-51317699 | **F** +86-21-51317698

E service@pylontech.com.cn

W www.pylontech.com.cn